

SIMPLE  
AS WATER

Pools Catalogue

**emec**<sup>®</sup> 





SIMPLE  
AS WATER

Pool Catalogue  
2023

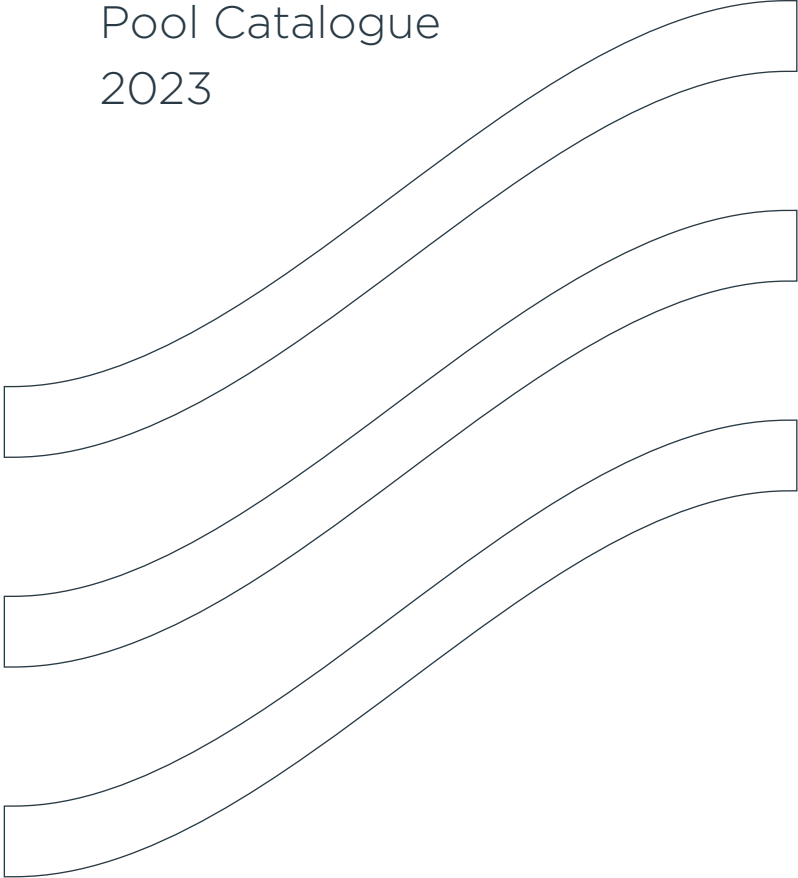



# EMEC

## SYSTEMS FOR SWIMMING POOLS



### Flexibility and innovation

Flexibility and innovation are fundamental to us. Since 1982, we have been designing and producing reliable, cutting-edge instruments for water treatment and chemicals dosing. As a company, we are open to change and, just like water, we have branched out over time, spreading out into wide-ranging areas, from industrial water treatment to potabilization to water purification, from food and beverage industry to swimming pools.

#### OUR VALUE

Being at the cutting edge means constant study. Our R&D and design departments are where our heart beats. Extremely high-profile engineers and technicians are committed to developing software and designing hardware, but also to studying and evaluating hydraulic and mechanical components. The customers and their satisfaction have always been at the heart of what we do, so we pay constant attention to the quality of our production processes, through a constantly updated and cutting-edge range of industrial machines.

#### QUALITY AND SAFETY, FIRST OF ALL

We are entirely responsible for every stage of the process, from invention to delivery. Our products undergo up to 10 quality checks and are tested four times before reaching the customer. The quality management system of our production process is ISO 9001 certified and has customer satisfaction as its ultimate goal, as well as continuous improvement of company performance.

Customers satisfaction comes hand-in-hand with ensuring safety for them, their operators and final users. Our dosing pumps and controllers are UL certified to guarantee full compliance with general requirements for safety of use, while **NSF** certifications guarantee that our pumps do not release hazardous pollutants into the water and therefore are fully safe for use in contact with drinking water, for example in the food production industry, or at recreational facilities like swimming pools and spas.

#### COMPETENCE AND PROFESSIONALISM

Extremely high performance, top quality and high

technology are our greatest assets. But there is more. Every day, we safeguard something equally important: human capital. Our co-workers are the best professionals on the market; the most expert and competent people.

For this reason our organizational model is designed to manage their safety and health in an organic and systematic way, respecting the international standard **BS OHSAS 18001**.

#### ENVIRONMENTAL SUSTAINABILITY

The adoption of an environmental management system compliant with the international standard **ISO 14001** arises from the awareness of the imprint that human activities leave on the planet. Our environmental protection management system allows us to minimize the impact of production processes (with emissions well below the prescribed limits), of products and of raw materials used (with the recycling of most of the waste materials), also thanks to an energy saving system that covers all company spaces and to the use of renewable energy sources.



#### 100% MADE IN ITALY

All our products are 100% Made in Italy.



#### WARRANTY

5 years warranty for our dosing pumps and controllers.



Certified to NSF/ANSI/CAN 50



# POOL CATALOGUE

## Smart systems

**POOLBRAVO**

6/7

## Dosing pumps

**MULTIFUNCTIONS MODE DOSING PUMPS**

*Flow control*

8/11

**CONSTANT MODE DOSING PUMPS**

*Flow control*

12/15

**PROPORTIONAL DOSING PUMPS WITH PARAMETER MEASUREMENT**

*PH / ORP measurement & control*

16/17

**DOSING PUMPS**

*Anti algae, active oxygen, flocculant measurement and control*

27/29

**DOSING PUMPS**

*Scent and essences dosing for health spa*

30/31

**DOSING PUMPS**

*Foot-bath disinfection systems*

32/33

**DOSING PUMPS**

*Dechloration system for filters cleaning waters*

34/35

## All-in-one dosing pumps

**ALL-IN-ONE DOSING PUMPS**

*WDPHXX series, also available with peristaltic pumps*

18/19

**ALL-IN-ONE DOSING PUMPS**

*Multiparameter measurement and control*

20/23

**ALL-IN-ONE DOSING PUMPS**

*Dry feeder and salt chlorine generator measurement and control  
Bromine, pH and active oxygen measurement and control*

24/26

## Digital controllers

### **SINGLE PARAMETER DIGITAL CONTROLLERS**

36/39

*pH - ORP - Cl<sub>2</sub> - Br<sub>2</sub> - O<sub>3</sub> - Total Chlorine - H<sub>2</sub>O<sub>2</sub> - Inductive conductivity  
- Turbidity + Temperature measurement and control*

### **MULTIPARAMETER DIGITAL CONTROLLERS**

40/43

*Measurement and control of several parameters simultaneously*

## Remote measurement and control

### **ERMES**

44/45

### **MODEM AND EXTERNAL MODULES FOR COMMUNICATION**

--/49

*For LD, WDPHXX and CENTURIO controller series*

## All-in-one control and dosing solutions

### **ALL-IN-ONE SYSTEMS**

50/53

### **ALL-IN-ONE SYSTEMS**

54/55

*Digital system with open amperometric cell ECL6*

### **ALL-IN-ONE SYSTEMS**

56/57

*Digital system with closed amperometric cell SCL3S/20 and PEF1*

### **ADVANCED ALL-IN-ONE SYSTEMS**

58/61

## Accessories

### **LIST OF COMPATIBLE ACCESSORIES**

62/65

# SWIMMING POOL MADE SMART



 POOLBRAVO



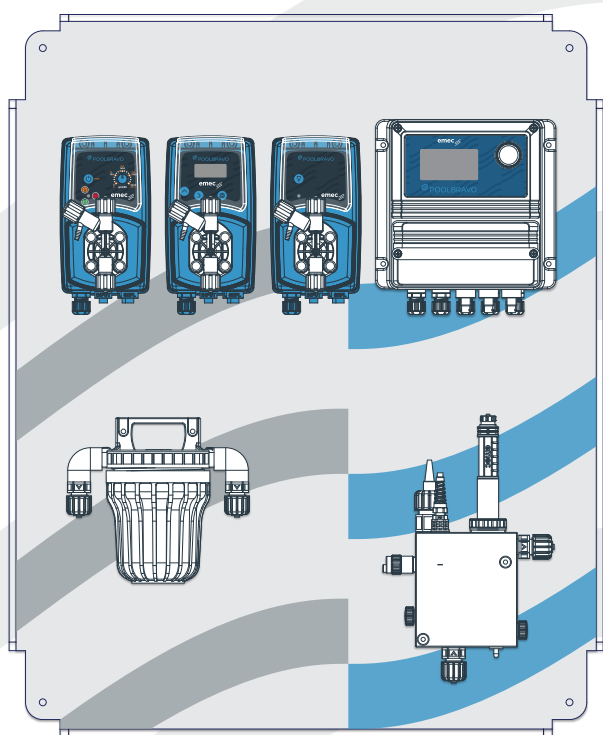

A multi-colored LED light is installed on PEF probe-holder in order to quickly signal, through an opening on the cover, specific operation statuses or possible alarms according to the color of the light.

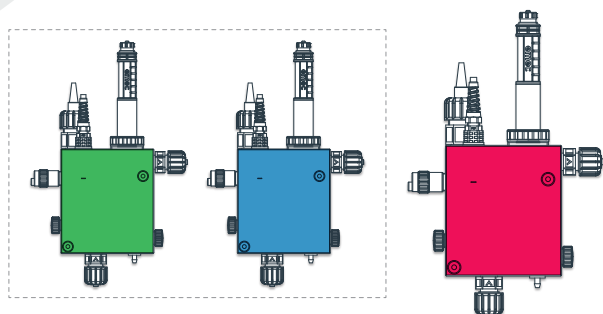

**GREEN** or **BLUE** (depending on the version) means the device is correctly functioning.

**RED** means the device is in an alarm status.

## POOLBRAVO

The POOLBRAVO integrated system has been designed to offer an all-in-one solution that is easy to use and highly accurate, able to minimize the need for manual intervention on swimming pool water and to reduce the consumption of chemical products. An elegant cover makes POOL BRAVO suitable for any installation context and, besides safeguarding from accidental liquid loss, preserves at the same time the cleanliness of the inner components and their integrity.

POOLBRAVO is a turnkey product available in different configurations to immediately and easily manage the main measurement parameters concerning the treatment of swimming pool water, thus optimizing the dosing and consumption of the chemical products necessary for the compliance with chemical-physical water requirements.

### COMPLETE CONTROL

The LD multiple reading digital system inside POOLBRAVO gives you the complete control over the measurement parameters and over the dosing of chemicals, besides being easy to use thanks to the LCD display and the ENCODER control knob that makes simple to browse through its configuration menus. Complete control also comes from the wide range of probes that can measure hydrogen peroxide, oxygen, bromine, chlorine, ozone, peracetic acid and chlorine dioxide. EMEC V series dosing pumps complete POOL BRAVO dosing system.

### REMOTE CONTROL

EMEC exclusive online system ERMES enables you to remotely control and regulate POOLBRAVO from any smartphone or PC, so to keep the status of your swimming pool always under control, wherever you are.

# Multifunctions mode dosing pumps

## Flow control

(Constant, Divide, Multiply, PPM, Batch, Volt, mA, %, ml/q), stand-by\* and flow sensor input\*, alarm output\*\* and level control.

## AMS MF



### PRESSURE

7 bar  
3 bar  
2 bar

### FLOW

20 l/h  
40 l/h  
60 l/h



## KMS MF



### PRESSURE

2 bar

5 bar

20 bar

### FLOW

18 l/h

10 l/h

1 l/h

# Multifunctions mode dosing pumps

## Flow control

(Constant, Divide, Multiply, PPM, Batch, Volt, mA, %, ml/q), stand-by\* and flow sensor input\*, alarm output\*\* and level control.

## TMS MF



### PRESSURE

4 bar  
3 bar  
1 bar

### FLOW

20 l/h  
30 l/h  
50 l/h



## VMS MF



### PRESSURE

5 bar  
10 bar  
3 bar  
2 bar

### FLOW

1 l/h  
4 l/h  
10 l/h  
15 l/h

\*Non disponibile su mod. VMS MF

\*\*Uscita allarme livello opzionale su mod. VMS MF e mod. VCL

# Constant mode dosing pumps

## Flow control

Constant mode dosing pumps with level and flow control. Double frequency scale.

## AMS CL PLUS



### PRESSURE

7 bar  
3 bar  
2 bar

### FLOW

20 l/h  
40 l/h  
60 l/h



## K CL PLUS



### PRESSURE

2 bar

5 bar

20 bar

### FLOW

18 l/h

10 l/h

1 l/h

# Constant mode dosing pumps

## Flow control

Constant mode dosing pumps with level and flow control. Double frequency scale.

T CL



### PRESSURE

- 4 bar
- 3 bar
- 1 bar

### FLOW

- 20 l/h
- 30 l/h
- 50 l/h





## V CL



### PRESSURE

5 bar

10 bar

3 bar

2 bar

### FLOW

1 l/h

4 l/h

10 l/h

15 l/h

# Proportional dosing pumps with parameter measurement

*PH / ORP measurement & control*

Proportional dosing pumps with pH and/or ORP measurement and control, with overdose alarm.

## TMS PH & TMS RH



### **TMS PH**

Proportional pump driven by internal built-in pH meter (0÷14pH) stand-by and level control, supplied without pH probe.

### **TMS RH**

Proportional pump driven by internal built-in ORP meter (0÷1000mV) stand-by and level control, supplied without ORP probe.

### **PRESSURE**

4 bar  
3 bar  
1 bar

### **FLOW**

20 l/h  
30 l/h  
50 l/h



## VMS PO



### VMS PO

Proportional pump driven by internal built-in pH meter (0/14pH) or ORP meter (-1000mV/+1000mV). Parameter set by menu. Level control. PVDF pump head and accessories. Fast calibration on standard value. Restore last calibration.

### PRESSURE

5 bar  
10 bar  
3 bar  
2 bar

### FLOW

1 l/h  
4 l/h  
10 l/h  
15 l/h

# PERISTALTIC WD: PRECISE, RELIABLE, NOISELESS



 WD

# All-in-one dosing pumps

WDPHXX series, also available with **peristaltic pumps**

18/19



## WDPHXX / WDPHXX PER

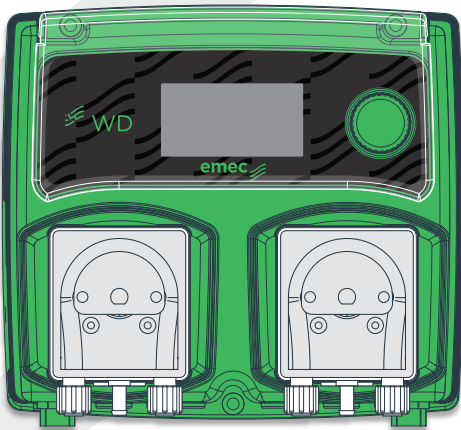

Standard WDPHXX PER pump

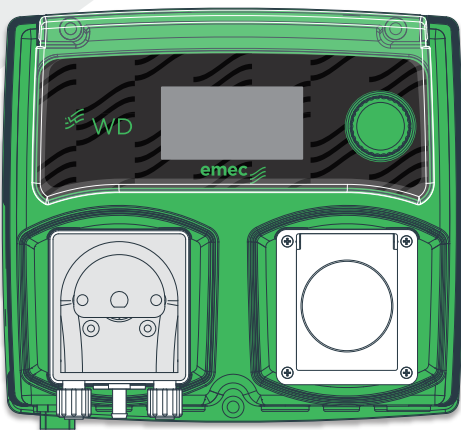

WDPHXX PER pump with output  
(230 VAC / 10A) for sterilisers or Cl/  
Br feeders

WDPHxx series has been created by EMEC to provide a complete and small-sized solution for swimming pool water treatment. WDPHXX systems are all-in-one, compact instruments which integrate two dosing pumps and a control instrument into a single, easy to use, highly precise system.

WDPHXX systems can measure pH and another parameter that depends on the chosen model: chlorine, bromine, Redox, antialgae, flocculant, active oxygen. A wide range of products for the highest flexibility.

### WDPHXX PER: RELIABLE AND NOISELESS

WDPHXX proportional dosing systems in the versions with peristaltic dosing pumps (WDPHXX PER) are the best solution to be installed where silent operation and high reliability are required, like in spa and wellness facilities.

The integrated peristaltic pumps are indeed the most suitable for micro-dosing needs with lower pressure, ensuring at the same time an absolutely constant and accurate flow rate. Moreover, peristaltic pumps promise to have low power consumption thanks to low voltage.

### COMPLETE CONTROL, EVEN REMOTELY

A clear reading of data and an easy browsing through function menus are made simple by a wide backlit LCD display and by the "Encoder" control knob, in order to quickly program the working modes you need, to set alarms and to manage outputs.

You can also remotely control WDPHXX systems from any smartphone or PC with EMEC exclusive online system ERMES, so to keep the status of your plant always under control wherever you are.

# All-in-one dosing pumps

*Multiparameter measurement and control*

## WDPHCL

*pH & Chlorine*



### WDPHCL / WDPHCL PER

Swimming pool controller with 2 dosing pumps for acid (pH) and chlorine (Cl<sub>2</sub>). Liquid ends and pump head made of PVDF.

Also available with peristaltic pumps (WDPHCL PER).

Wheel control system

Alarm output

RS485 output

Measurement range:  
from 0 to 14 pH  
from 0 to 10 mg/l Cl<sub>2</sub>

### PRESSURE

5 bar

3 bar

1 bar

### FLOW

1 l/h

10 l/h

3 l/h



## WDPHRH

*pH & ORP*



### WDPHRH / WDPHRH PER

Swimming pool controller, 2 dosing pumps for acid (pH) and disinfectant (ORP).  
Liquid ends and pump head made of PVDF.

Also available with peristaltic pumps (WDPHRH PER).

Wheel control system

Alarm output

RS485 output

Measurement range:  
from 0 to 14 pH  
from 0 to 1000 mV

### PRESSURE

5 bar

3 bar

1 bar

### FLOW

1 l/h

5 l/h

3 l/h

# All-in-one dosing pumps

Multiparameter measurement and control

## WDPHCLS

pH and Chlorine/Bromine



### WDPHCLS / WDPHCLS PER

Proportional controller with 1 dosing pump driven by internal built-in pH and Chlorine/Bromine meter. Output: (SCHUKO plug) for sterilisers or Cl/Br feeders. Liquid ends and pump head made of PVDF.

Also available with peristaltic pumps (WDPHCLS PER).

Measurement range:  
from 0 to 14 pH  
from 0 to 10 mg/l Cl<sub>2</sub> / Br<sub>2</sub>

Option: free of voltage EV contact.

### PRESSURE

5 bar  
3 bar  
1 bar

### FLOW

1 l/h  
10 l/h  
3 l/h

### EV OUTPUT

230 VAC

### MAX LOAD

10 A





# WDPHRHS

*pH and ORP*



## WDPHRHS / WDPHRHS PER

Proportional controller with 1 dosing pump driven by internal built-in pH and ORP meter. Output: (SCHUKO plug) for sterilisers or CI/Br feeders. Liquid ends and pump head made of PVDF.

Also available with peristaltic pumps (WDPHRHS PER).

Measurement range:  
from 0 to 14 pH  
from 0 to 1000 mV

Option: free of voltage EV contact.

## PRESSURE

5 bar  
3 bar  
1 bar

## FLOW

1 l/h  
10 l/h  
3 l/h

## EV OUTPUT

230 VAC

## MAX LOAD

10 A

# All-in-one dosing pumps

*Dry feeder and salt chlorine generator measurement and control  
Bromine, pH and active oxygen measurement and control*

## WDPHCA



### **WDPHCA / WDPHCA PER**

Proportional controller with 2 dosing pumps for pH and anti algae. 230VAC EV proportional or on/off output for Cl/Br feeders.

Weekly anti algae timer and level probe.

Liquid ends and pump head made of PVDF.

Also available with peristaltic pumps (WDPHCA PER).

Wheel control system

Alarm output

RS485 output

Measurement range:

from 0 to 14 pH

from 0 to 10 mg/l Cl<sub>2</sub>

### **PRESSURE**

3 bar

1 bar

### **FLOW**

10 l/h

3 l/h

*Optional: free of voltage EV contact.*



## WDPHCF



### WDPHCF / WDPHCF PER

Proportional controller with 2 dosing pumps for pH (acid- base) and flocculant. 230VAC EV proportional or on/off output for Cl/Br feeders. Level probe and gr/day flocculant dosing. Liquid ends and pump head made of PVDF.

Also available with peristaltic pumps (WDPHCF PER).

Wheel control system

Alarm output

RS485 output

Measurement range:  
from 0 to 14 pH  
from 0 to 10 mg/l Cl<sub>2</sub>

Optional: free of voltage EV contact.

### PRESSURE

3 bar

1 bar

### FLOW

10 l/h  
(sezione pH)

3 l/h

# All-in-one dosing pumps

*Dry feeder and salt chlorine generator measurement and control  
Bromine, pH and active oxygen measurement and control*

## WDPHOS



### WDPHOS & WDPHOS PER

Proportional controller with 2 dosing pumps for pH (acid- base) and active oxygen. Level probe. Temperature reading with enclosed probe. Weekly or daily (hr) active oxygen dosing. Liquid ends and pump head made of PVDF.

Also available with peristaltic pumps (WDPHCA PER).

Settings:

- daily or weekly timer
- temperature compensation - pool size

Wheel control system Alarm output

RS485 output

PH measurement range: from 0 to 14

*Optional: free of voltage EV contact.*

### PRESSURE

3 bar  
3 bar  
1 bar

### FLOW

10 l/h  
(for pH)  
4 l/h  
(for active oxygen)  
3 l/h



## Dosing pumps

*Anti algae, active oxygen, flocculant measurement and control*

### VMS EN

*Anti algae*



#### **VMS EN**

Anti algae pump with weekly timer for shock type water treatment. Quantities adjustable in cc units.

Level probe included.

#### **PRESSURE**

3 bar

#### **FLOW**

10 l/h

# Dosing pumps

*Anti algae, active oxygen, flocculant measurement and control*

## VM5A H<sub>2</sub>O<sub>2</sub>

*Active oxygen*



**VM5A H<sub>2</sub>O<sub>2</sub>**  
Active oxygen pump.

Also available with peristaltic pump (VM5A H<sub>2</sub>O<sub>2</sub> PER).

Settings:  
- day/week timer  
- temperature compensation  
- pool size

Level and temperature probes included.

### PRESSURE

3 bar  
2 bar

### FLOW

4 l/h  
10 l/h



## VCOG & VCLG

*Flocculant*



### VCOG & VCLG

Metering pump for flocculant.

Double scale (24h):

- 0 to 300 gr/day

- 0 to 3000 gr/day

Level probe included.

### PRESSURE

5 bar

### FLOW

3000 gr/24h

## Dosing pumps

*Scent and essences dosing for spa*

### VCLS

*Scent and essences dosing*



#### **VCLS**

Silenced pump for scent and essences dosing at spas and hammam centres.

Double scale:

- 0 to 100 g/hr

- 0 to 1000 g/hr

Level probe included.

#### **PRESSURE**

7 bar

#### **FLOW**

1 l/h





## VCLSE

*C.E. Scent and essences dosing*



### VCLSE

Silenced pump for scent and essences dosing at spas and hammam centres. Contact (N.O.) for external control.

Double scale:

- 0 to 100 g/hr

- 0 to 1000 g/hr

Level probe included.

### PRESSURE

7 bar

### FLOW

1 l/h

# Dosing pumps

*Foot-bath disinfection systems*

## VMS MF + CTFI



### VMS MF + CTFI

Foot-bath disinfection system.

It works with a pulsar sender water meter (1/2" size).

% control with level probe.

### PRESSURE

5 bar

### FLOW

12 l/h

### CTFI

1/2"



## TMS MF + CTFI



### TMS MF + CTFI

Foot-bath disinfection system.

It works with a pulser sender water meter (1/2" size).

% control with level probe.

### PRESSURE

3 bar

### FLOW

30 l/h

### CTFI

1/2"

# Dosing pumps

Dechloration system for filters cleaning waters

## VCLD



### VCLD

Dechlorination system for waters filters (chlorine).  
Level meter. SEFT C contact less water sensor (fittings 3/4").  
SEFT P flow sensor (fittings 1/2").

Settings:

- 0-800 gr/h
- 0-8000 gr/h

Level probe included.

SEFT C and SEFT P are optional.

### PRESSURE

3 bar

### FLOW

10 l/h



## VMS MF + CTFI & CWFA



### VMS MF + CTFI & CWFA

Dechloration system for water filters.

It works with a pulse sender water meter (1.1/2" or 2" size).

Proportional volume control (product ppm) with level meter.

### PRESSURE

3 bar  
2 bar

### FLOW

10 l/h  
15 l/h

### CTFI

1"1/2 e 2"

### CWFA

3" e 4"

## Single parameter digital controllers

*pH - ORP - Cl<sub>2</sub> - Br<sub>2</sub> - O<sub>3</sub> - Total Chlorine - H<sub>2</sub>O<sub>2</sub> - Inductive conductivity - Turbidity + Temperature measurement and control*

## LDS series



### LDS / LDS PLUS

Options:

- USB for data log recording
- Current Output (0/4 - 20 mA)
- Ethernet
- 3G/4G modem
- MODBUS
- WIFI

### LDS PLUS features

- 5 relais (2 setpoint; alarm; probe cleaning; circulation)
- Probe Cleaning
- PID
- mA output



## MODELS

LDSPH / LDSPH PLUS

**pH measurement and control**

LDSRH / LDSRH PLUS

**ORP measurement and control**

LDSCCL / LDSCCL PLUS

**Chlorine measurement and control (reading scale based on probe)**

LDSCD / LDSCD PLUS

**Conductivity measurement and control**

LDSCDIND / LDSCDIND PLUS

**Inductive conductivity measurement and control (ECDINDPT probe)**

LDSETORB2 / LDSETORB2 PLUS

**Turbidity measurement and control (ETORB2 probe)**

LDSTRC / LDSTRC PLUS

**Florescence measurement and control**

LDSFL / LDSFL PLUS

**Fluorine measurement and control**

Wheel with "EASY-NAV" control, flow control, local & Remote Control,ERMES web communication, permanent data storage with system log, PT100 temperature probe, Stand-by input, Alarms: damaged probes - max dosage - threshold - levels - flow, Programmable delay at dosing start-up (up to 60 minutes), Priority dosage, Automatic temperature compensation, Probe readout menu (LDSCDIND), Working modes: on/off, impulsive proportional, proportional PWM and fixed PWM, Automatic or manual dosing activity, mA output (option).



# Single parameter digital controllers

## RACK MOUNTING CONTROLLERS

Controller for: pH, ORP, Chlorine (Total chlorine, Free Chlorine, Chlorine Dioxide, Hydrogen Peroxyde, Ozone, Bromine, Peracetic Acid depending on the probe), Conductivity (Probes not included). 2 On-Off/proportional setpoints, Flow alarm, Flow sensor stand-by input, 0÷20 mA or 4÷20 mA output proportional to read measured value and programmable in the reading range.

## JA PRO



JA PRO control instruments are rack mounting (96x96) single reading systems with temperature reading. On/Off, impulsive proportional and PID are main working modes.

It can set and monitor: pH, ORP, chlorine (depending on the probe: total chlorine, free chlorine, chlorine dioxide, hydrogen peroxide, ozone, bromine or paracetic acid) and conductivity ( $\mu\text{S/S}$  - Ohm - TDS / PPM) with automatic range and probe / product selection (H<sub>3</sub>PO<sub>4</sub> - H<sub>2</sub>SO<sub>4</sub> - HNO<sub>3</sub> - HCl - NaOH - NaCl). Probes are not included.

JA PRO has: 2 setpoints (on/off, proportional), flow alarm, flow sensor stand-by input, 0-20 mA or 4-20 mA output proportional to read value and programmable in the reading range, alarm output. Available low voltage 12VDC or 24VDC power supply. Available IP54 protection cover.

JA PRO is equipped with mA module and MODBUS serial communication to be connected to other devices on RS485 networks and TCP/IP MODBUS.

### JA PRO

Options:

- 12VDC or 24VDC power supply
- IP54 protection

### JA PRO

Features:

- mA module
- MODBUS serial communication





## J DIGITAL & DIN DIGITAL

### J DIGITAL

*Rack mounting (96x48) single reading systems*

J DIGITAL control instruments are a series of rack mounting (96x48) single reading systems that meets many applications.

It can set and monitor: pH, ORP, chlorine (depending on the probe: total chlorine, free chlorine, chlorine dioxide, hydrogen peroxide, ozone, bromine or paracetic acid), conductivity, ozone, chlorine dioxide and temperature.

Probes are not included.

J DIGITAL models have: 2 setpoints (on/off, proportional), flow alarm, flow sensor stand-by input, 0-20 mA or 4-20 mA output proportional to read value and programmable in the reading range. Available IP54 protection cover.



### DIN DIGITAL

*Rail mounting (6 modules) single reading system*

DIN DIGITAL control instruments are a series of rail mounting (6 modules) single reading systems that meets many applications.

It can set and monitor: pH, ORP, chlorine (depending on the probe: total chlorine, free chlorine, chlorine dioxide, hydrogen peroxide, ozone, bromine or paracetic acid), conductivity, ozone, chlorine dioxide and temperature. Probes are not included.

DIN DIGITAL models have: 2 setpoints (on/off, proportional), flow alarm, flow sensor stand-by input, 0-20 mA or 4-20 mA output proportional to read value and programmable in the reading range.



# Multiparameter digital controllers

*Measurement and control of several parameters simultaneously*

pH / Total Chlorine / Free chlorine / Combined Chlorine / ORP / Turbidity Conductivity / Inductive conductivity / Bromine / Ozone + Temperature

## LDPHXX series



### LDPHXX / LDPHXX PLUS

Options:

- USB for data log recording
- Current Output (0/4 - 20 mA)
- Ethernet
- 3G/4G modem
- MODBUS
- WIFI

### LDPHXX PLUS features

- 5 relais (2 setpoint; alarm; probe cleaning; circulation)
- Probe Cleaning
- PID
- mA output

\*Specificare i parametri e il tipo di sonda per cloro al momento dell'ordine



## MODELS

LDPHRH / LDPHRH PLUS

pH (0/14) - Redox (0/1000 mV) - °C (0/99,9)

LDPHCL\* / LDPHCL\* PLUS

pH (0/14) - Cloro (0/10 mg/l Cl<sub>2</sub>) - °C (0/99,9)

LDPHBR / LDPHBR PLUS

pH (0/14) - Bromo (0/10 mg/l Br<sub>2</sub>) - °C (0/99,9)

LDPHDO / LDPHDO PLUS

pH (0/14) - O<sub>2</sub> (0/200 mg/l H<sub>2</sub>O<sub>2</sub>) - °C (0/99,9)

Controller for acid (pH) and a second parameter. Wheel with “EASY-NAV” control, Flow control, Local & Remote Controlled, ERMES web communication, Permanent data storage with system log, PT100 temperature probe, Stand-by input, Alarms: damaged probes - max dosage - threshold - levels - flow, Programmable delay at dosing start-up (up to 60 minutes), Priority dosage, Probe readout menu, Probes check up, Multiple probe readings can be viewed, Working modes: on/off, impulsive proportional, proportional PWM and fixed PWM, Automatic or manual dosing activity, Chlorine/Bromine selection with ECL6 (LDPHCL), mA output (option).



# Multiparameter digital controllers

*Measurement and control of several parameters simultaneously*

pH / Total Chlorine / Free chlorine / Combined Chlorine / ORP / Turbidity Conductivity / Inductive conductivity / Bromine / Ozone + Temperature

## CENTURIO POOL series



### **CENTURIO**

Options:

- USB for data log recording
- Current Output (0/4 - 20 mA)
- Ethernet
- 3G/4G modem
- MODBUS RTU & TCP/IP
- WIFI



## RANGES

pH

from 0 to 14 pH

Bromine

from 0 to 10 mg/l

ORP

from -1000 to 1000 mv

Turbidity

from 0 to 4000 NTU

Total chlorine

from 0 to 20 mg/l

Temperature

from 0 to 100 °C

Free chlorine

from 0 to 20 mg/l

Conductivity

from 0 to 300 mS

Combined chlorine

from 0 to 10 mg/l

CENTURIO POOL is a digital regulation and measurement system for multi-parameter control in swimming pool water treatment. It combines complete control and extreme ease of use with the elegance of the case made by Giugiaro Design.

Equipped with a Linux operating system, a high-performance ARM A5 microprocessor and a large color touchscreen, CENTURIO POOL can be set to work with pH priorities and can control flocculant output, shock chlorination and backwashing of filters and simultaneously manage up to 10 channels to read the following parameters: pH, free chlorine, combined chlorine, active free chlorine, total chlorine, conductivity, ORP, NTU, product levels, pool water level. For each channel CENTURIO POOL has 2 digital setpoints (ON / OFF), 2 proportional setpoints (IS), 1 mA output setpoint and 1 Temperature setpoint; you can also set 6 timers with a maximum of 10 daily schedules each.

CENTURIO POOL can be connected to the Internet via WIFI, GSM or ETHERNET and remotely controlled via ERMES, the online control system designed by EMEC. It is also equipped with the MODBUS serial communication protocol (optional) which allows connection with other devices within RS485 networks.



# YOUR POOL ONLINE





# Remote measurement and control

Through ERMES online service you can remotely control and regulate all the parameters of all EMEC enabled products and interactively monitor probes, instrument inputs, products level, temperature and setpoints.

## ADVANTAGES

- Less plant intervention and inspections.
- Reports on the current status of the network's devices and connections (probes, outputs, alarms, setpoints)
- Instant alarm notifications via sms or email
- Data report of all plant instruments
- Activity log like graphs and charts that can be downloaded on your PC (excel or pdf)

## HOW DOES ERMES WORK?

Enter [www.ermes-server.com](http://www.ermes-server.com), register for free, configure and name your systems. All EMEC instruments with encoder and ETHERNET or 3G/4G configuration will be immediately connected and available.

In addition to the remote control, through ERMES you can receive, via email, alarm messages with various report options on the status of your systems. If you have an instrument with 3G/4G configuration you can also receive reports on your phone via SMS.

On request, the instruments can be supplied with a SIM card and mobile data subscription (only on instruments equipped with a 3G/4G module. Subscription paid by the customer).

EMEC compatible systems:

- CENTURIO
- LDS
- MTOWER
- WD

CONFIGURATION	FEATURES	CONNECTION TYPE	REQUIREMENTS	FUNCTIONS
BASIC	/	/	/	RS485 link to EMEC instruments
ADVANCED USB	USB	Download data log from controller to Usb drive	/	RS485 link to other EMEC instruments Data Log recording on USB drive
ETHERNET	LAN network	Remote control via WEB APP ERMES ( <a href="http://www.ermes-server.com">www.ermes-server.com</a> )	LAN (RJ-45) network	RS485 link to other EMEC instruments ERMES Web App (PC, smartphone, tablet) Email Alarm messages
3G/4G	MOBILE connection	Remote control via WEB APP ERMES ( <a href="http://www.ermes-server.com">www.ermes-server.com</a> )	Mobile Network Coverage	RS485 link to other EMEC instruments ERMES Web App (PC, smartphone, tablet) Email/SMS Alarm messages
MODBUS	PLC connection to other devices via RS485 or TCP/IP (only Centurio)	PLC plant management	/	PLC connection output for parameters reading/setting
WIFI	WIFI connection between instrument and web	Remote control via WEB APP ERMES ( <a href="http://www.ermes-server.com">www.ermes-server.com</a> )	WIFI Network Coverage	RS485 link to other EMEC instruments ERMES Web App (PC, smartphone, tablet) Email Alarm messages

# ERMES

# Remote measurement and control

## CONNECTION EXAMPLE

ETHERNET - WIFI

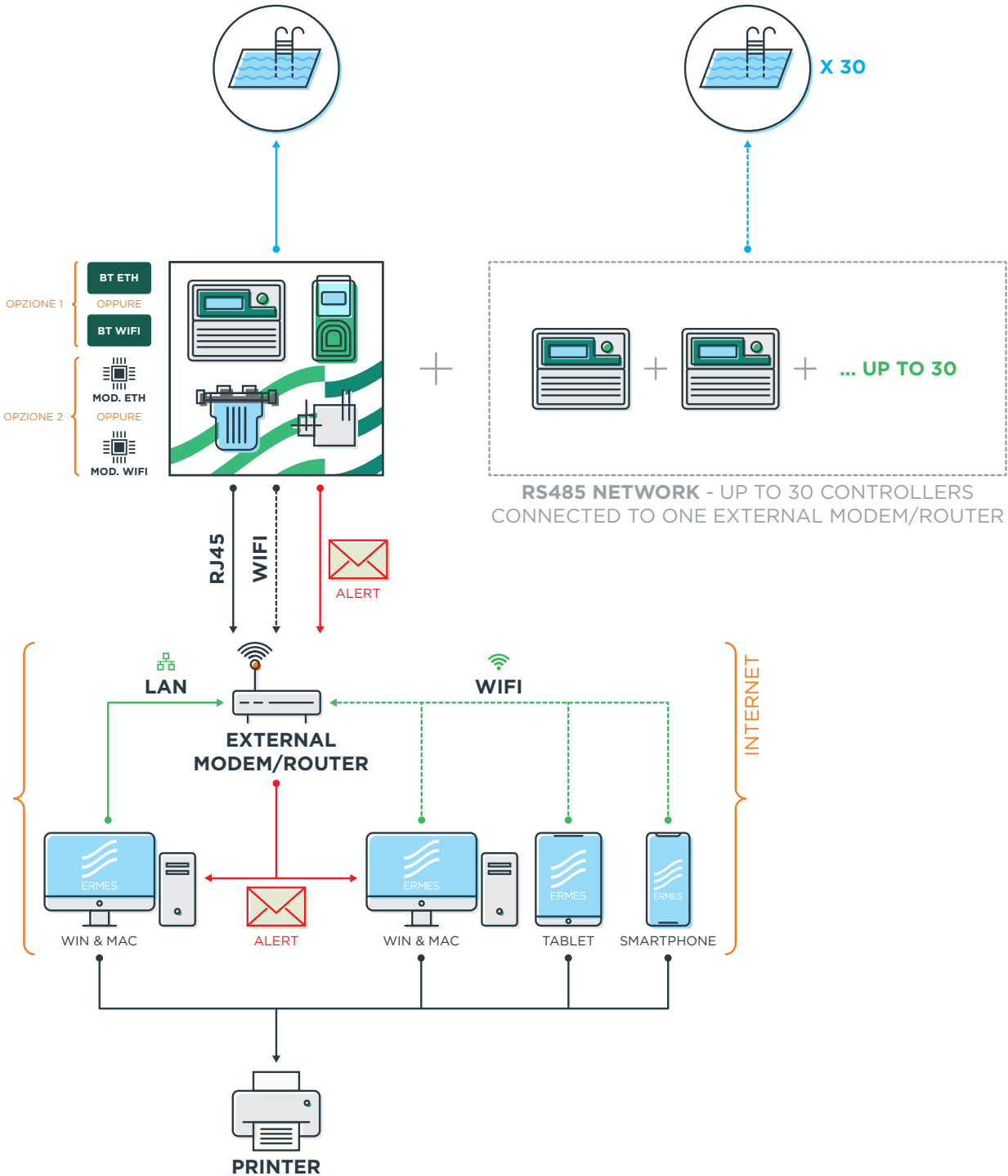



# CONNECTION EXAMPLE

GSM - 3G/4G

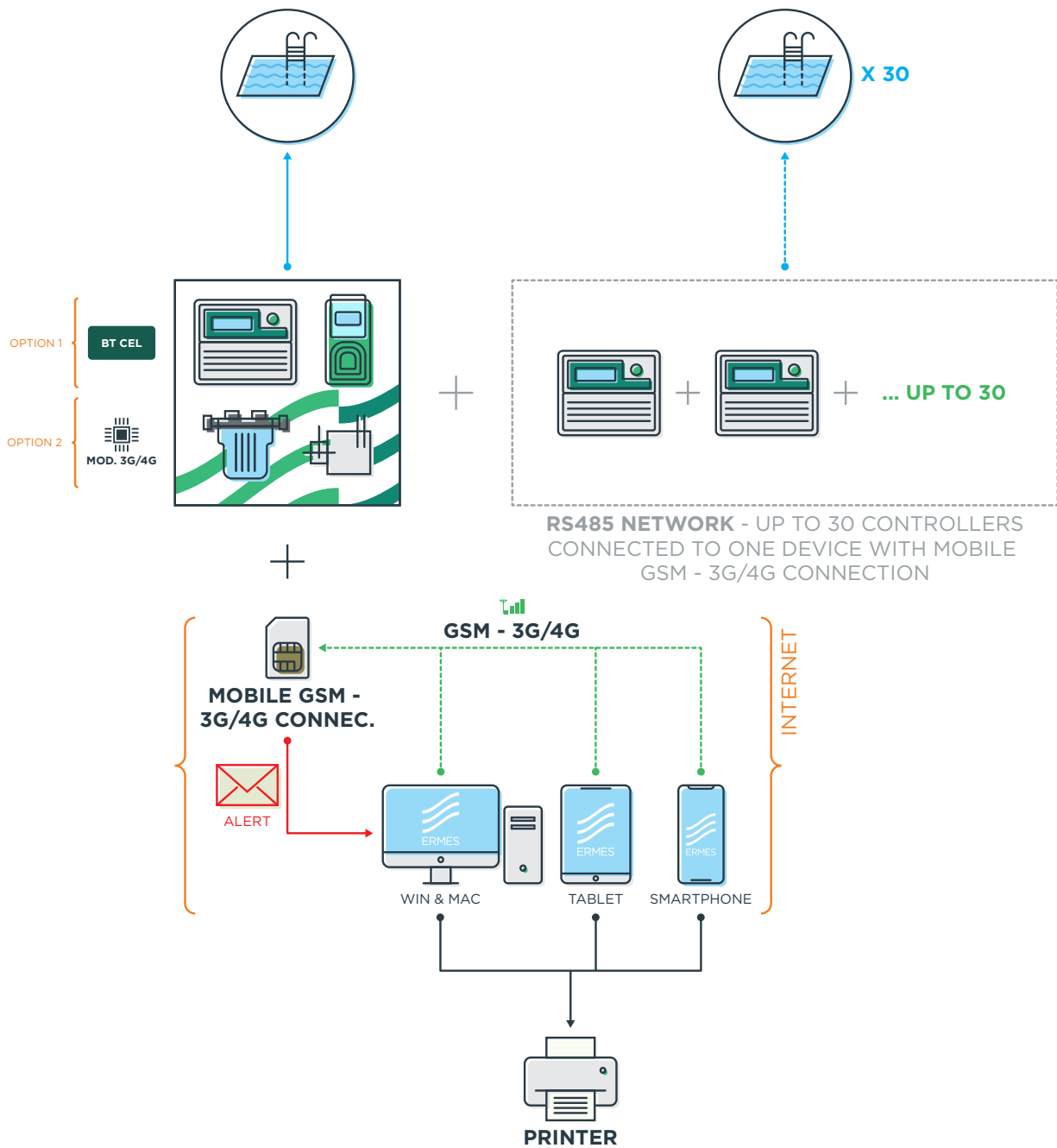

# Remote measurement and control

## CONNECTION EXAMPLE

DATA DOWNLOAD & UPLOAD VIA USB

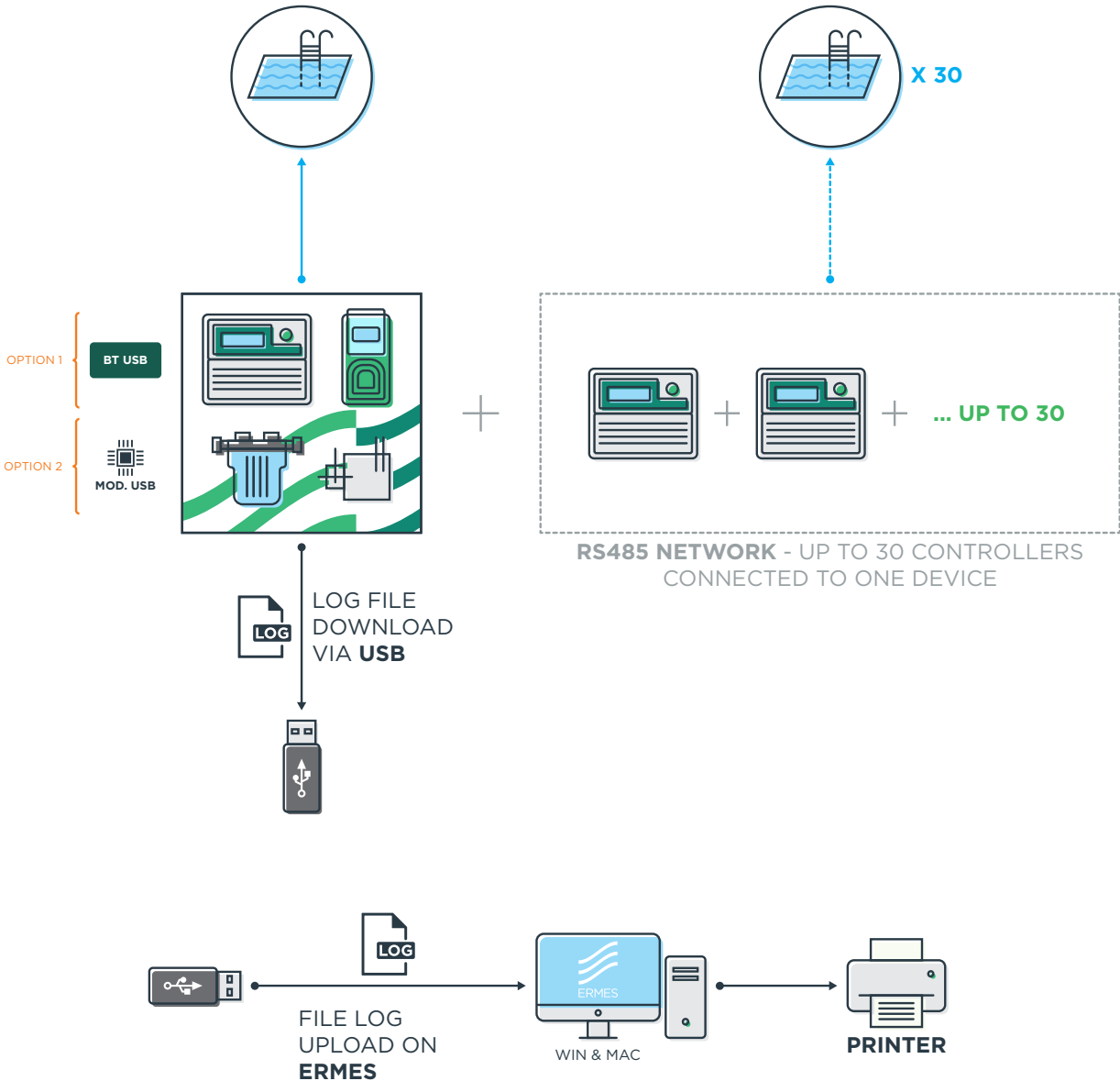

# Modem and external communication modules 48/49

For LD, WDPHXX and CENTURIO controller series

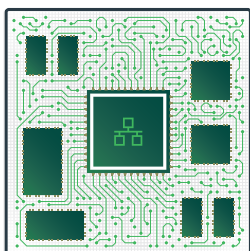

**ETHERNET MODULE**  
Internal standard ETHERNET (RJ45) controller for LD encoder.

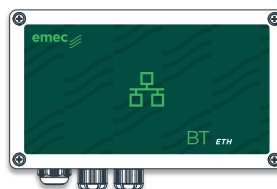

**BT ETH**  
Ethernet controller for standard RJ45 network. IP65.

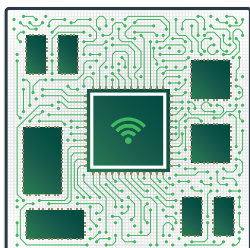

**WIFI MODULE**  
Module for WIFI network. IP65.



**BT WIFI**  
Module for WIFI connection. IP65.

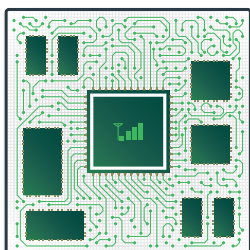

**3G/4G MODULE**  
Internal 3G/4G modem for LD encoder.



**BT CEL**  
Modem for mobile network. IP65.

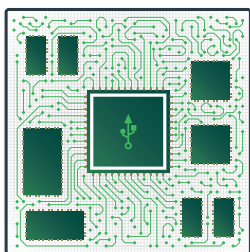

**USB MODULE**  
Module for USB connection. IP65.

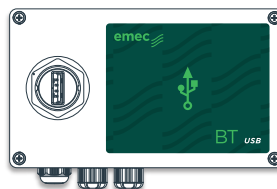

**BT USB**  
USB module for USB datalog recording. IP65.

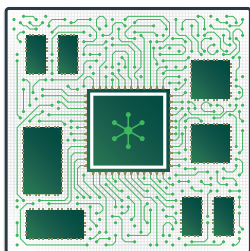

**MODBUS MODULE**  
MODBUS RTU module for PLC connection.

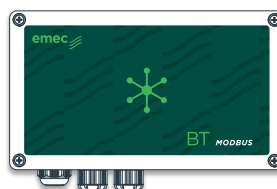

**BT MODBUS**  
Serial communication module for PLC connection.

## All-in-one systems

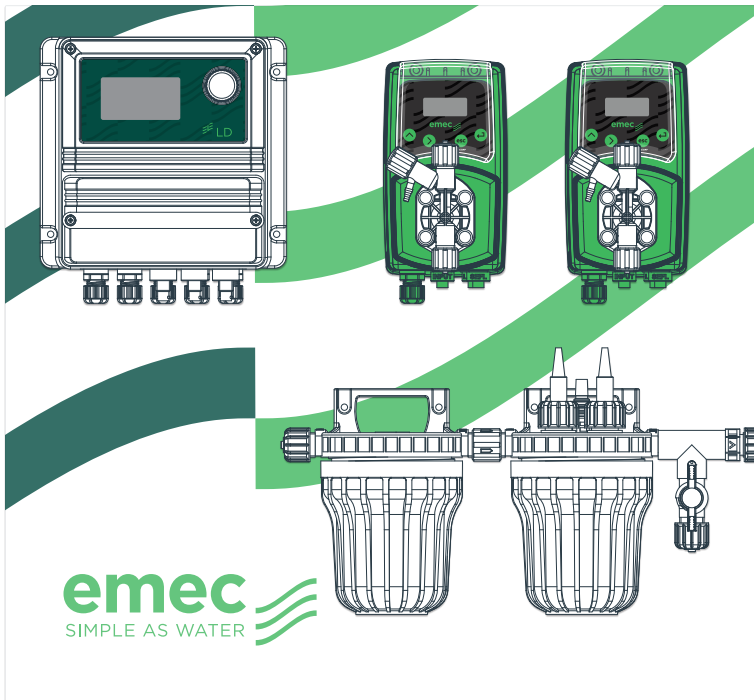

## PA-LDPHRH

### PH AND ORP PROPORTIONAL CONTROL

- Controller LDPHRH
- Dosing pump VMS MF 03 10 (10 l/h)
- Dosing pump VMS MF 03 10 (10 l/h)
- Filter NFIL
- pH probe EPHS
- ORP probe ERHS
- Probe holders NPED4

**Size:** 600x650 mm

Customized coloured background on demand

## PA-WDPHOS

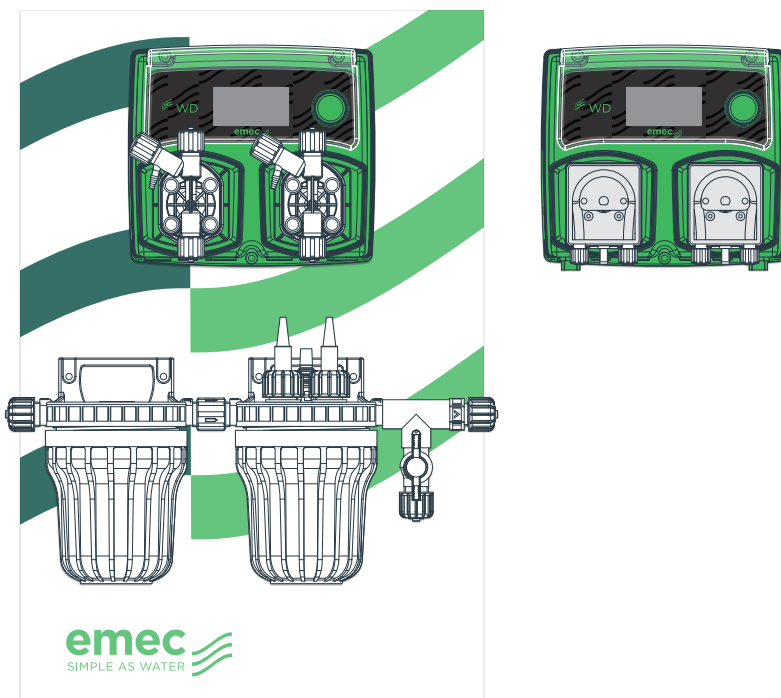

### PH AND ACTIVE OXYGEN PROPORTIONAL CONTROL

- Controller WDPHOS 03 10 (10 l/h) and 03 04 (4 l/h), or WDPHOS PER 01 03 (with peristaltic dosing pumps)
- Filter NFIL
- Temperature probe ETEPTCH18
- pH probe EPHS
- Probes holder NPED4

**Optional:** Also available with WDPHOS PER

**Size:** 400x600 mm

Customized coloured background on demand.

OUTPUT **RS485**

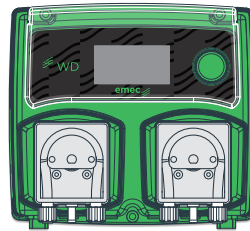
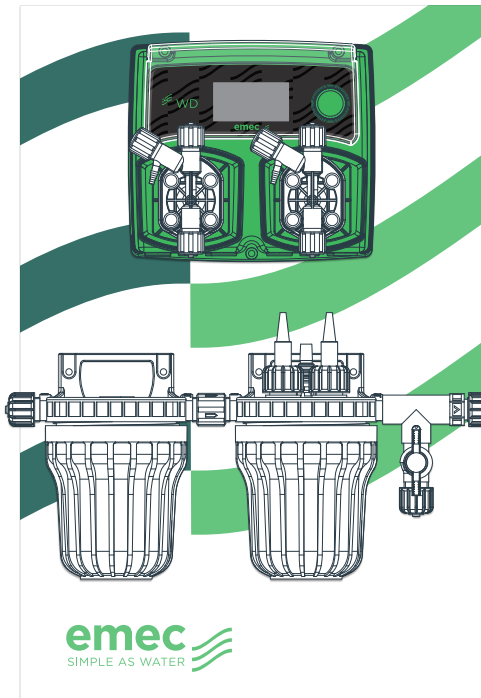

## PA-WDPHRH

### PH AND ORP PROPORTIONAL CONTROL

- Controller WDPHRH 03 10 (10 l/h), 05 01 (1 l/h) and 10 04 (4 l/h), or WDPHRH PER 01 03 (with peristaltic dosing pumps).
- Filter NFIL
- Probe ORP ERHS
- Probe pH EPHS
- Probes holder NPED4

**Optional:** Also available with WDPHRH PER

**Size:** 400x600 mm  
Customized coloured background on demand.

OUTPUT **RS485**

## PA-WDPHEV

### PH OR ORP PROPORTIONAL CONTROL, DRY FEEDER SOLENOID VALVE OR SALT GENERATOR (230VAC / 10A) OUTPUT

- Controller WDPHRHS 07 06 (6 l/h) or 05 01 (1 l/h) 2. Filter NFIL
- Probe ORP ERHS
- Probe pH EPHS
- Probes holder NPED4

**Size:** 400x600 mm  
Customized coloured background on demand.

OUTPUT **RS485**

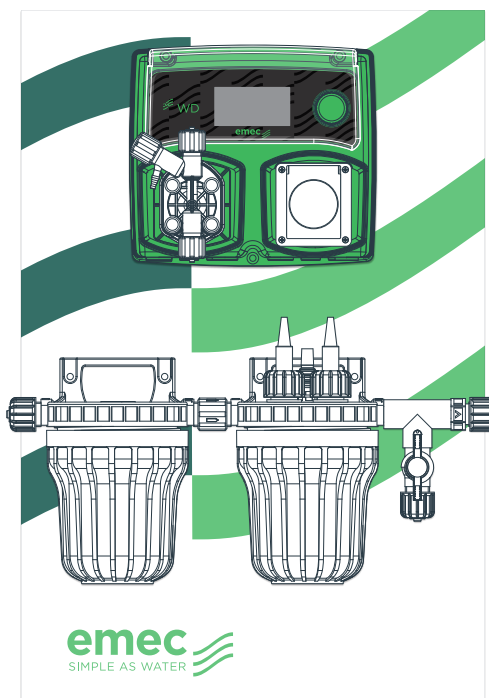

## All-in-one systems

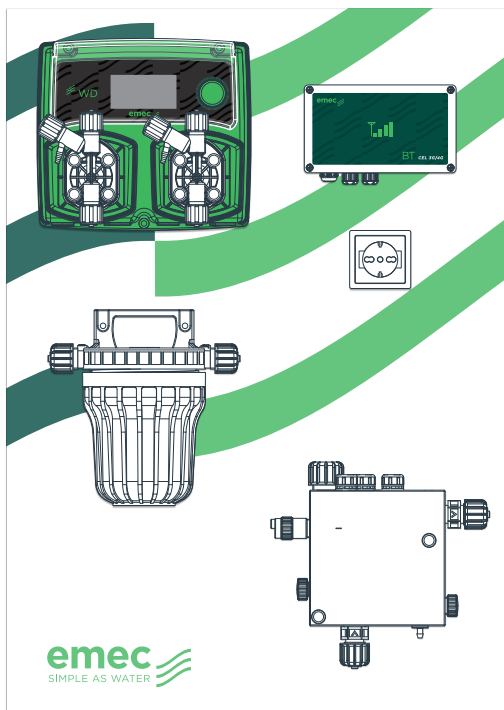

## PA-WDPHCFS/PA-WDPHCASA

### SALT CHLORINE GENERATOR VERSION:

*Flocculant with continuous dosing PA-WDPHCFS/PA-WDPHCASA  
Anti algae with weekly timer PA-WDPHCASA*

- Controller WDPHCA 07 06 (6 l/h), 05 01 (1 l/h) or 10 04 (4 l/h)
- Probe pH EPHS
- Filter NFIL
- Proximity sensor SEPR
- Open amperometric cell ECL6
- Modem BT CEL
- Output 10 A 220 VAC

**Optional:** Free of voltage EV contact.

**Size:** 500x700 mm  
Customized coloured background on demand.

OUTPUT **RS485**

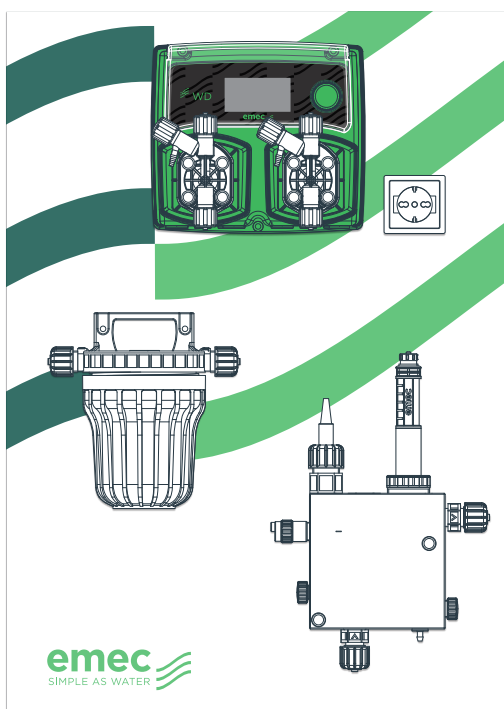

## PA-WDPHCA/CF/PA-WDPHBA/BF

### CHLORINE / BROMINE DRY FEEDER:

*Flocculant with continuous dosing PA-WDPHCFB/PA-WDPHBA/BF  
Anti algae with weekly timer PA-WDPHCA/CF*

- Controller WDPHCL 07 06 (6 l/h), 05 01 (1 l/h) or 10 04 (4 l/h)
- Probe pH EPHS
- Chlorine probe SCL3S/20 or Bromine probe SBR 1/20
- Filter NFIL
- Proximity sensor SEPR
- Probes holder PEF1R
- Output 10 A 220 VAC

**Optional:** Free of voltage EV contact.

**Size:** 500x700 mm  
Customized coloured background on demand.

OUTPUT **RS485**



## PA-WDPHCL

### PH AND CHLORINE PROPORTIONAL CONTROL

- Controller WDPHCL 07 06 (6 l/h), 05 01 (1 l/h) or 10 04 (4 l/h), or WDPHCL PER 01 03 (with peristaltic dosing pumps).
- Filter NFIL
- Proximity sensor SEPR
- Probe pH EPHS
- Open amperometric cell ECL6

**Optional:** Also available with WDPHCL PER

**Size:** 500x700 mm

Customized coloured background on demand.

OUTPUT **RS485**

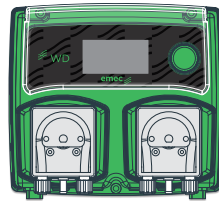
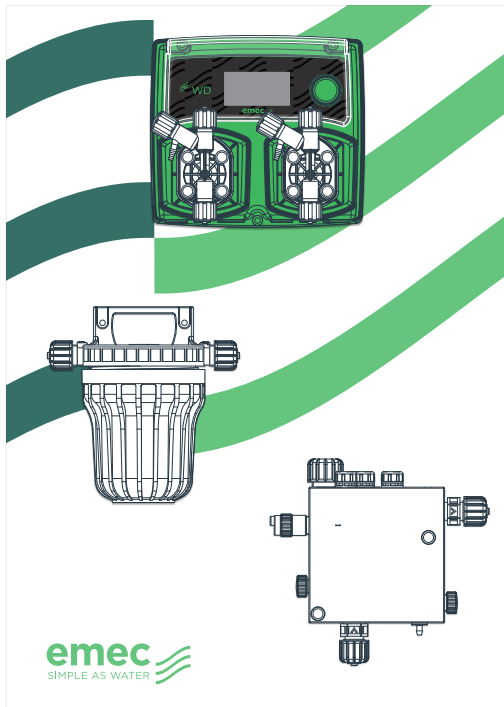

## PA-WDPHCLO

### PH AND CHLORINE PROPORTIONAL CONTROL (INORGANIC/ORGANIC)

- Controller WDPHCL 07 06 (6 l/h), 05 01 (1 l/h) or 10 04 (4 l/h), or WDPHCL PER 01 03 (with peristaltic dosing pumps).
- Filter NFIL
- Proximity sensor SEPR
- Probe pH EPHS
- Chlorine probe SLC3S/20
- Probes holder PEF1R

**Optional:** Also available with WDPHCLO PER

**Size:** 500x700 mm

Customized coloured background on demand.

OUTPUT **RS485**

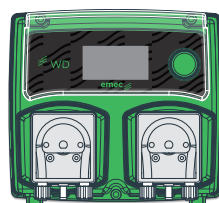
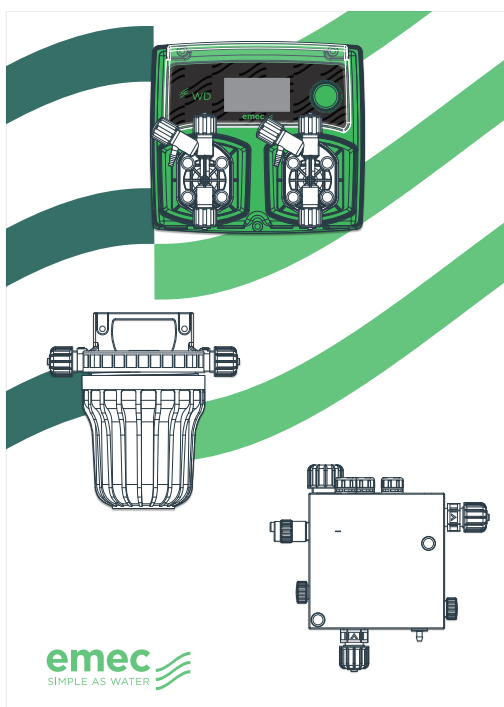

# All-in-one systems

Controller based system with open amperometric cell ECL6

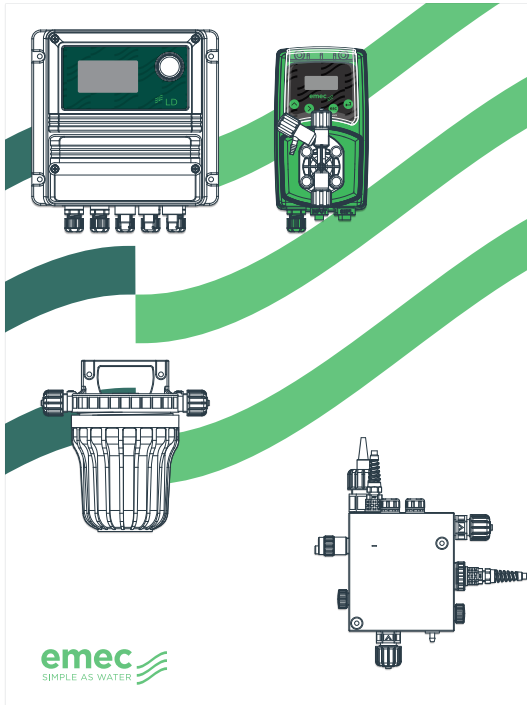

## PA-LDPHCL

**FOR DRY FEEDER USAGE (CHLORINE / BROMINE) OR SALT CHLORINE GENERATOR.  
MEDIUM SIZE POOL**

- Controller LDPHCL
- Dosing pump for acid VMS MF 03 10 (10 l/h) 3.  
Filter NFIL
- Probe pH EPHS
- Proximity sensor SEPR
- Temperature probe ETEPTCH18
- Open amperometric cell ECL6

**Size:** 600x800 mm

Customized coloured background on demand.

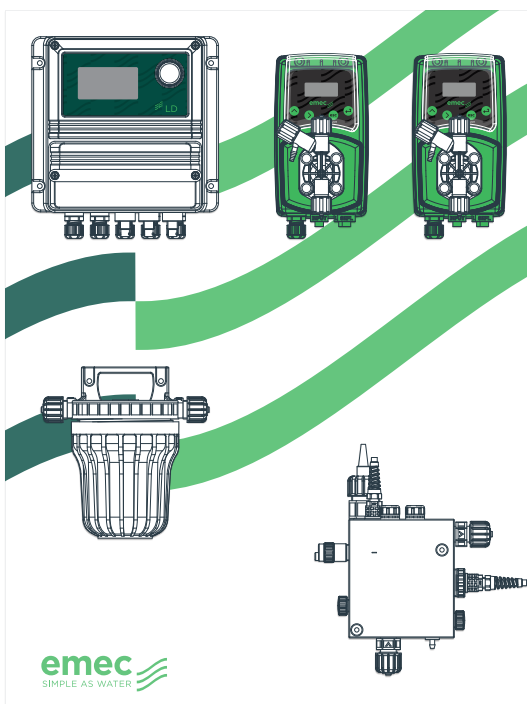

## PA-LDPHCLO

**PH AND CHLORINE PROPORTIONAL CONTROL.  
MEDIUM SIZE POOL**

- Controller LDPHCL
- Dosing pump for acid VMS MF 03 10 (10 l/h)
- Dosing pump for chlorine VMS MF 02 15 (15 l/h)
- Filter NFIL
- Probe pH EPHS
- Proximity sensor SEPR
- Temperature probe ETEPTCH18
- Open amperometric cell ECL6

**Size:** 600x800 mm

Customized coloured background on demand.



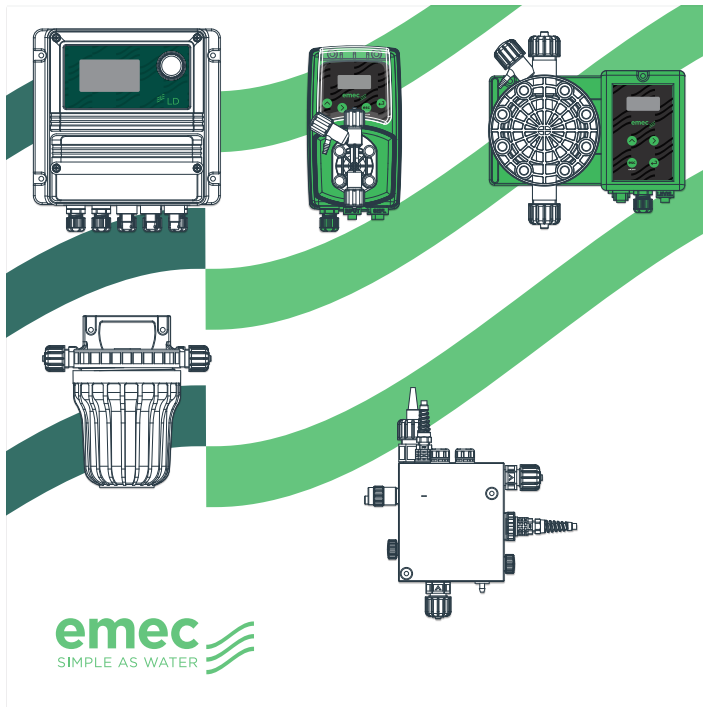

## PA-LDPHCLOB

### FOR PH AND CHLORINE PROPORTIONAL CONTROL. LARGE SIZE POOL

- Controller LDPHCL
- Dosing pump for acid VMS MF 02 15 (15 l/h)
- Dosing pump for chlorine TMS MF 03 30 (30 l/h)
- Filter NFIL
- Probe pH EPHS
- Proximity sensor SEPR
- Temperature probe ETEPTCH18
- Open amperometric cell ECL6

**Size:** 800x800 mm

Customized coloured background on demand.

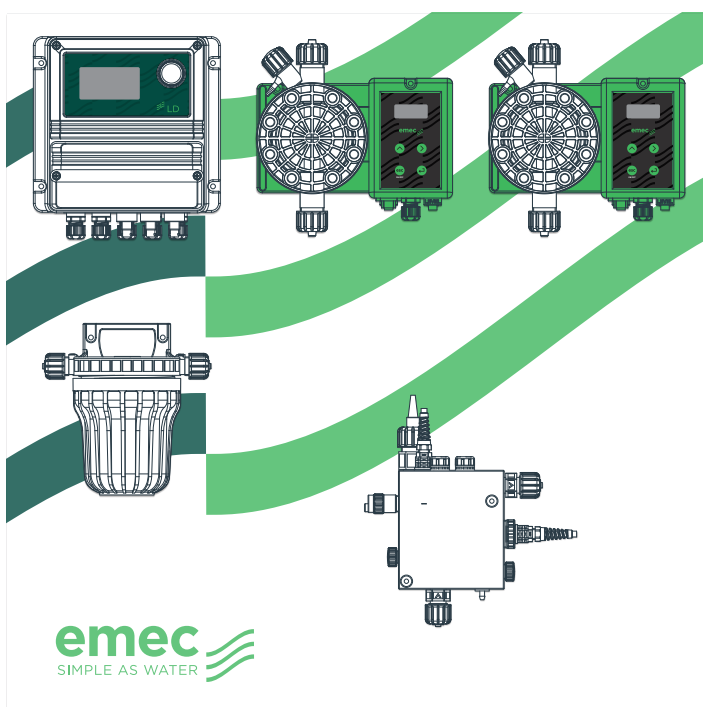

## PA-LDPHCLOBG

### FOR PH AND CHLORINE PROPORTIONAL CONTROL. LARGE SIZE POOL

- Controller LDPHCL
- Dosing pump for acid TMS MF 03 30 (30 l/h)
- Dosing pump for chlorine TMS MF 01 50 (50 l/h)
- Filter NFIL
- Probe pH EPHS
- Proximity sensor SEPR
- Temperature probe ETEPTCH18
- Open amperometric cell ECL6

**Size:** 800x800 mm

Customized coloured background on demand.

# All-in-one systems

Controller based system with closed amperometric cell SCL3S/20 and PEF1

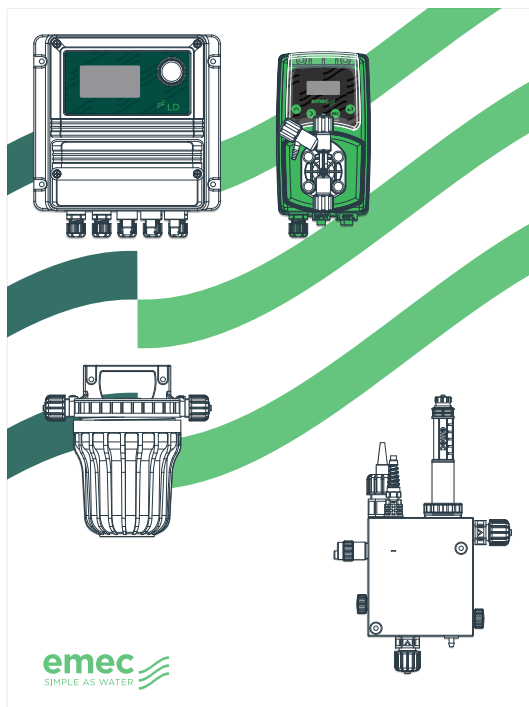

## PA-LDPHCLV & PA-LDPHBR

**FOR DRY FEEDER OR SALT CHLORINE GENERATOR. MEDIUM SIZE POOL**

- Controller LDPHCL
- Dosing pump for acid VMS MF 03 10 (10 l/h)
- Filter NFIL
- Proximity sensor SEPR
- Probe pH EPHS
- Chlorine probe SCL3S/20
- Temperature probe ETEPTCH18
- Probes holder PEF1R

**PA-LDPHBR:** Also available with bromine probe EBR 1/20.

**Size:** 600x800 mm  
Customized coloured background on demand.

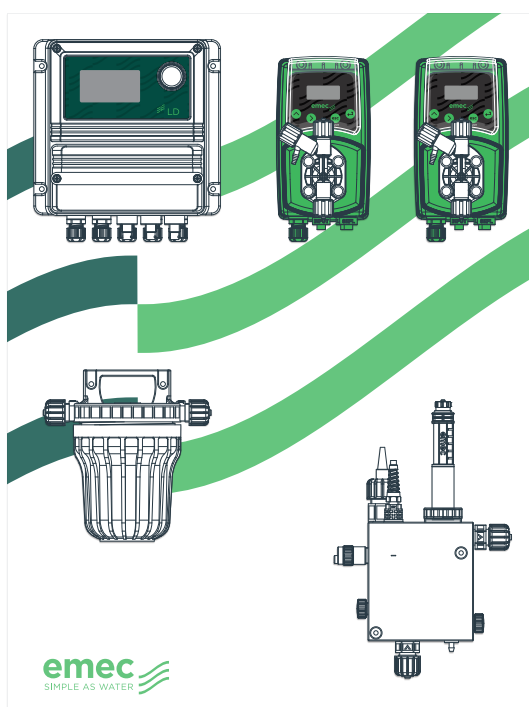

## PA-LDPHCLVD

**PH AND CHLORINE PROPORTIONAL CONTROL (INORGANIC/ORGANIC). MEDIUM SIZE POOL**

- Controller LDPHCL
- Dosing pump for acid VMS MF 03 10 (10 l/h)
- Dosing pump for chlorine VMS MF 02 15 (15 l/h)
- Filter NFIL
- Proximity sensor SEPR
- Probe pH EPHS
- Chlorine probe SCL3S/20
- Temperature probe ETEPTCH18
- Probes holder PEF1R

**Size:** 600x800 mm  
Customized coloured background on demand.

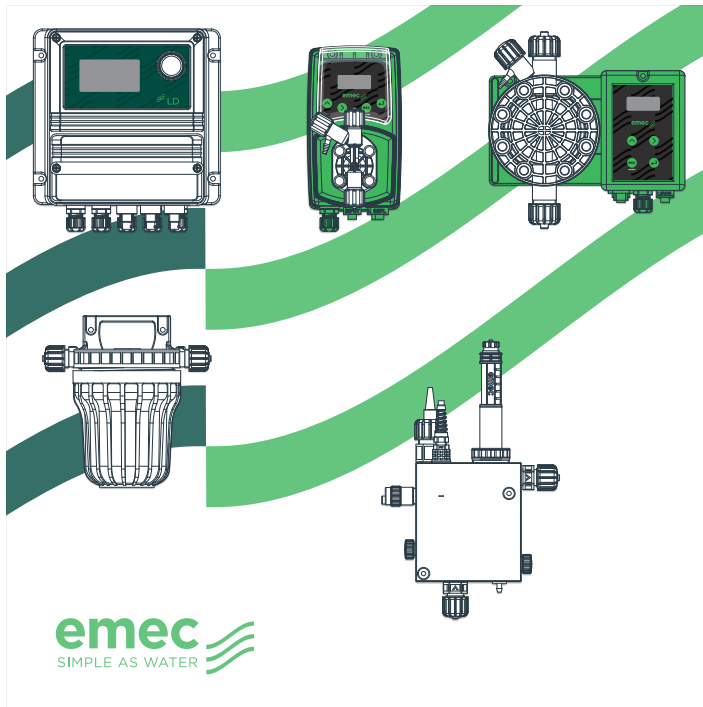

## PA-LDPHCLVG

### PH AND CHLORINE PROPORTIONAL CONTROL (INORGANIC/ORGANIC). BIG SIZE POOL

- Controller LDPHCL
- Dosing pump for acid VMS MF 02 15 (15 l/h)
- Dosing pump for chlorine TMS MF 03 30 (30 l/h)
- Filter NFIL
- Proximity sensor SEPR
- Probe pH EPHS
- Chlorine probe SCL3S/20
- Probes holder PEF1R

**Size:** 800x800 mm

Customized coloured background on demand.

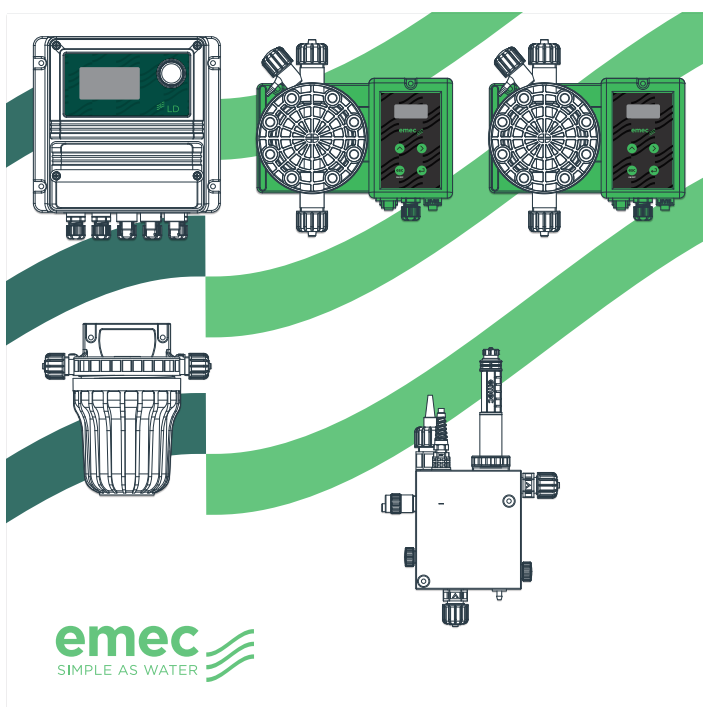

## PA-LDPHCLGD

### PH AND CHLORINE PROPORTIONAL CONTROL (INORGANIC/ORGANIC). BIG SIZE POOL

- Controller LDPHCL
- Dosing pump for acid TMS MF 03 30 (30 l/h)
- Dosing pump for chlorine TMS MF 01 50 (50 l/h)
- Filter NFIL
- Proximity sensor SEPR
- Probe pH EPHS
- Chlorine probe SCL3S/20
- Probes holder PEF1R

**Size:** 800x800 mm

Customized coloured background on demand.

# Advanced all-in-one systems

## PA-CED

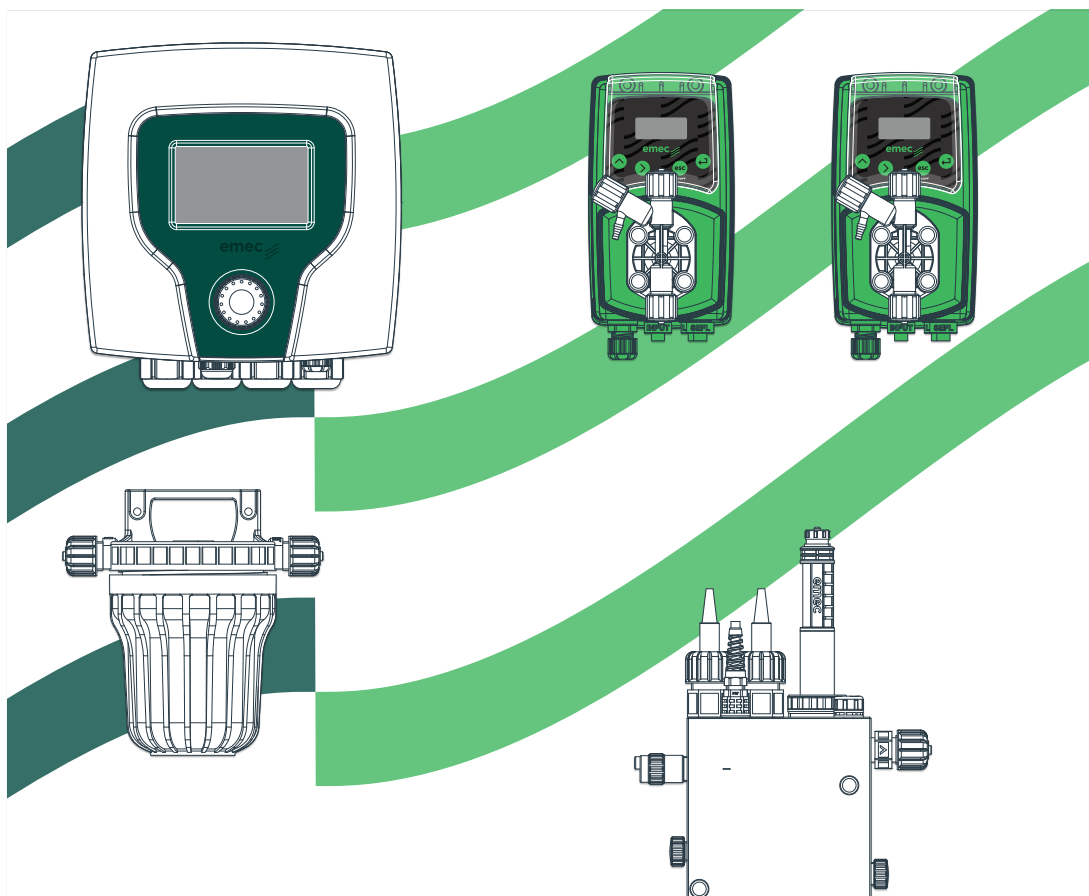

### PH, ORP, FREE CHLORINE AND TEMPERATURE CONTROL

- Controller CENTURIO POOL
- Dosing pump for acid VMS MF 03 10 (10 l/h)
- Dosing pump for chlorine VMS MF 02 15 (15 l/h)
- Filter NFIL
- Probe EPHS di pH
- Probe SCL3S/20 Free chlorine
- Proximity sensor SEPR
- Temperature probe ETEPTCH18
- Probe ERHS di ORP
- Probes holder PEFIR

**Optional:** also available with Centurio Pool controller

**Size:** 800x800 mm  
Customized coloured background on demand.

*The images contained in these pages are for illustrative purposes only. For more information on possible configurations, contact the sales office or your sales representative.*



## PA-CEDB

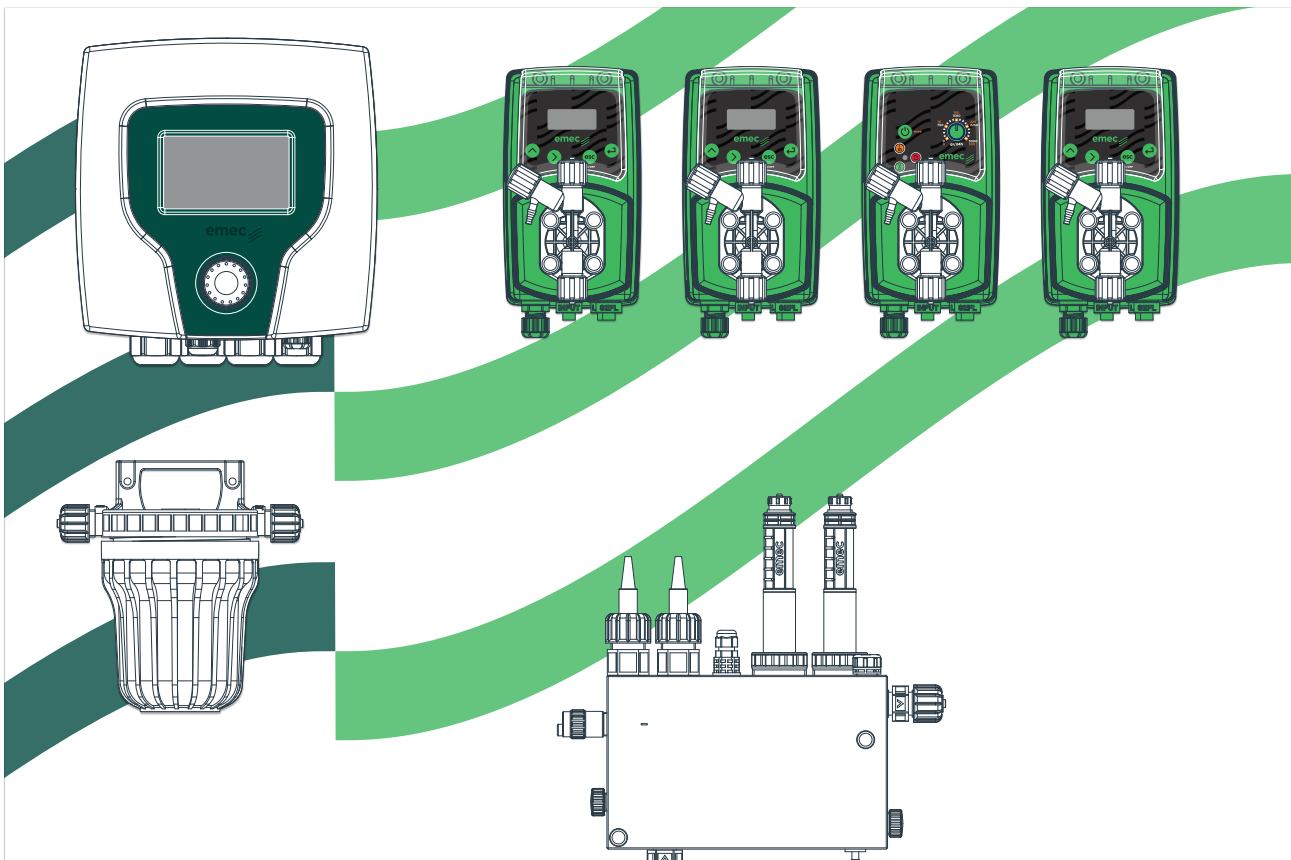

### PH, ORP, FREE CHLORINE, TOTAL CHLORINE, COMBINED CHLORINE AND TEMPERATURE ANTI ALGAE AND FLOCCULANT TREATMENT

- Controller CENTURIO POOL
- Dosing pump for acid VMS MF 03 10 (10 l/h)
- Dosing pump for chlorine VMS MF 02 15 (15 l/h)
- Dosing pump for flocculant VCLG
- Dosing pump for anti algae VMS MF 07 06 (6 l/h)
- Filter NFIL
- Probe di pH EPHS
- ORP probe ERHS
- Temperature probe ETEPTCH18
- Free chlorine probe SCL3S/20
- Total chlorine probe SCL8/20
- Proximity sensor SEPR
- Probes holder PEF22R

**Optional:** also available with Centurio Pool controller

**Size:** 1000x800 mm  
Customized coloured background on demand.

# Advanced all-in-one systems

## PA-CEDV

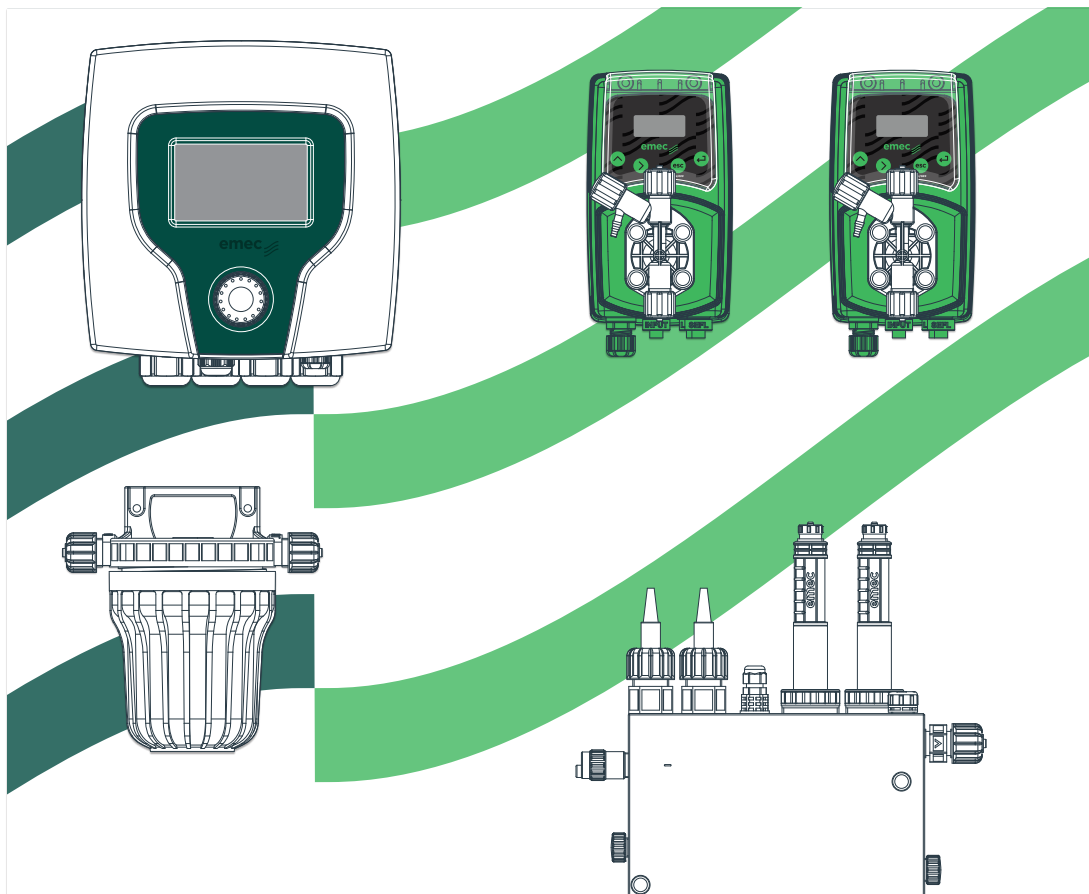

### PH, ORP, FREE CHLORINE, TOTAL CHLORINE, COMBINED CHLORINE AND TEMPERATURE

- Controller CENTURIO POOL
- Dosing pump for acid VMS MF 03 10 (10 l/h)
- Dosing pump for chlorine VMS MF 02 15 (15 l/h)
- Filter NFIL
- Probe di pH EPHS
- ORP probe ERHS
- Temperature probe ETEPTCH18
- Free chlorine probe SCL3S/20
- Total chlorine probe SCL8/20
- Proximity sensor SEPR
- Probes holder PEF22R

**Optional:** also available with Centurio Pool controller

**Size:** 800x800 mm  
Customized coloured background on demand.

*The images contained in these pages are for illustrative purposes only. For more information on possible configurations, contact the sales office or your sales representative.*



## PA-CEDT

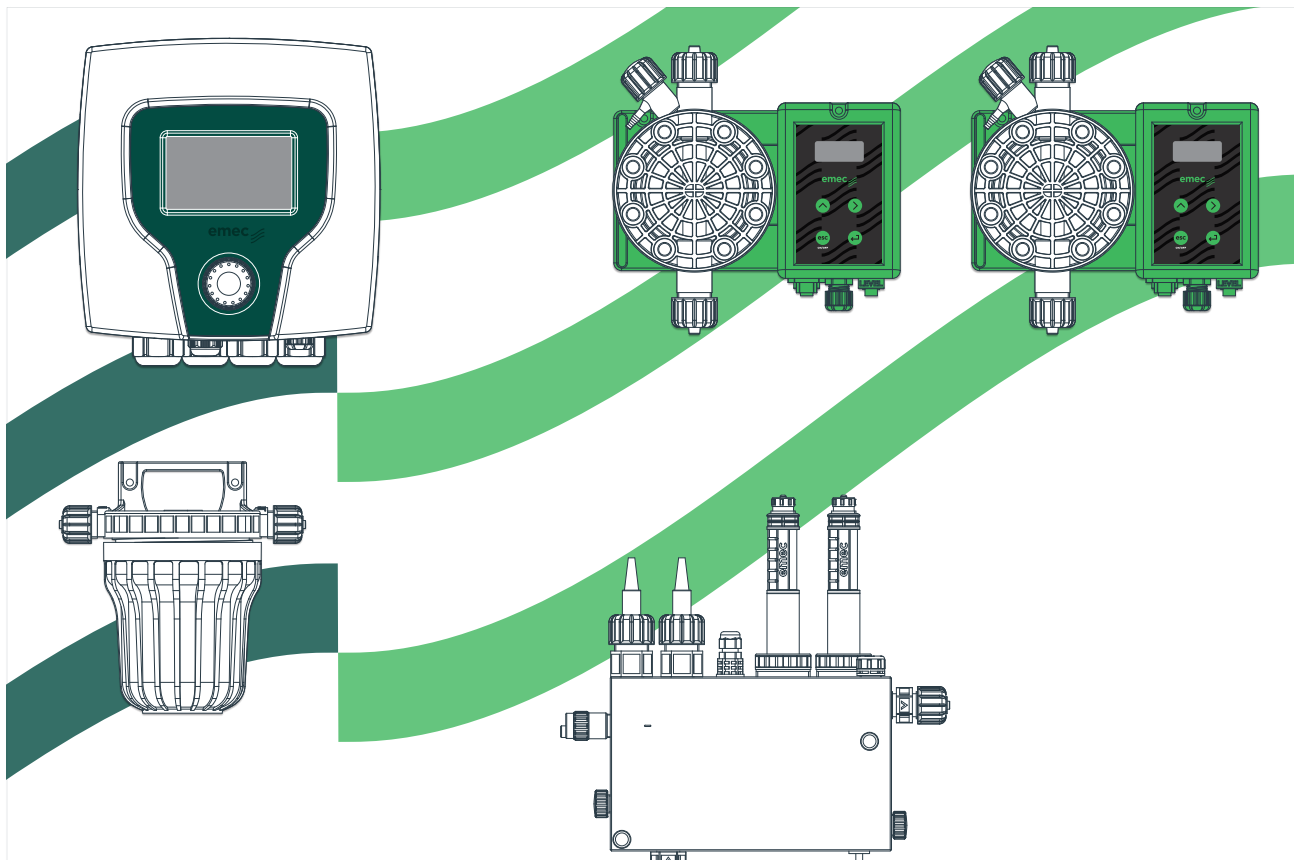

### PH, ORP, FREE CHLORINE, TOTAL CHLORINE, COMBINED CHLORINE AND TEMPERATURE

- Controller CENTURIO POOL
- Dosing pump for acid TMS MF 03 30 (30 l/h)
- Dosing pump for chlorine TMS MF 01 50 (50 l/h)
- Filter NFIL
- Probe di pH EPHS
- ORP probe ERHS
- Temperature probe ETEPTCH18
- Free chlorine probe SCL3S/20
- Total chlorine probe SCL8/20
- Proximity sensor SEPR
- Probes holder PEF22R

**Optional:** also available with Centurio Pool controller

**Size:** 1000x800 mm  
Customized coloured background on demand.

# Accessories



**EPHS**  
pH electrode for pressures up to 7 bar/70°C (3.5 bar/80°C). 0.8 m cable. Epoxy body. Minimum 100 µS.



**ERHS**  
ORP electrode for pressures up to 7 bar/70°C (3.5 bar/80°C). 0.8 m cable. Epoxy body. Minimum 100 µS.



**BUFFER SOLUTIONS**  
Buffer solutions for probes calibration.



**SCL8**  
Total chlorine amperometric cell (organic and inorganic), from 0 to 2 mg/l; from 0 to 20 mg/l, pH and temperature compensated.

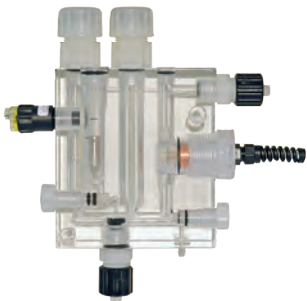

**ECL6 / ECL12**  
Free chlorine / bromine amperometric cell (organic and inorganic), from 0 to 10 mg/l. Flow switch and flow adjustment. Electrodes holder for pH, Redox and temperature. With proximity switch mod. SEPR. 6x8 fittings. With LED light sold as option.



**SCL35/20**  
Free chlorine amperometric cell (organic and inorganic), from 0 to 10 mg/l, pH and temperature compensated.



**ETEPT**  
Temperature probe PT100 (0°C÷100 °C, max 10bar). Suitable for LDxx, LDPHxx series instruments.



**PEF22R**  
Holder for Chlorine, pH, Redox, free Chlorine, total Chlorine and temperature probes. Provided type SEPR flow controller. With LED light sold as option.





**PEF1R**  
Off-line probes holder for ECL1/2/3/8/9/10/11 and pH, Redox and temperature, with flow switch and regulation. With proximity switch mod. SEPR. 6X8 fittings. With LED light sold as option.



**NFIL CA**  
Activated 5" filter with carbon filter cartridge. 6x8 fittings. With LED light sold as option.



**NFIL**  
Filter with cartridge. Washable. PET (60  $\mu$ ). 6x8 fittings. With LED light sold as option.



**NPED4**  
Off-line electrode holder for EPH and ERH electrodes. Epoxy  $\varnothing$ 12 casing. Max temperature 50° C, max pressure 5bar with flow sensor, N.O. switch, 6x8 fittings. With LED light sold as option.



**EVLA**  
Electrovalve for dry feeder (chlorine / bromine). 1/2" fitting.



**PELC**  
PVDF in-line electrode holder for pH / Redox electrodes with 1/2" or 3/4" thread. For saddle connection.



**PEL**  
PVDF in-line electrode holder for pH / Redox electrodes with 1/2" or 3/4" thread. For "T" connection.



**SBR1/20**  
Amperometric cell for bromine (reading range from 0 to 20 mg/l), pH and temperature compensated.

# Accessories



**MIXVN/8**  
 High speed mixer 1400 RPM. AISI shaft-PVC coated, different lengths available (630-730-830-930 mm). Marine impeller, diameter 70mm.



**MIXN/8**  
 Slow speed mixer 70/200 RPM. AISI shaft-PVC coated, different lengths available (630-730-830-930 mm). 3-blade impeller, diameter 150mm.



**MIXN/MAN**  
 Manual mixer. PVC shaft, different lengths available (500-600 and 700-800 mm). Impeller diameter 130 mm.



**MIX "PISTON"**  
 Manual mixer. PVC shaft, different lengths available (500-600 and 700-800 mm). Impeller diameter 130 mm.



**LASP**  
 Suction lances with level control, for tanks up to 25 liters.



**LASP**  
 Suction lances with level control, for tanks up to 1000 liters.



**LINIR**  
 1/2" injection lance for dosing sodium hypochlorite in hard water. Self cleaning. FKM B o-ring. PVC body.



**PVDF INJECTION VALVE**  
 PVDF made injection valve with 1/2" or 3/4" fittings.



**MF MULTIFUNCTION VALVE**  
Multifunction valve (pressure, safety, antisiphon and bleed) 1/2" connections for different hoses diameters. FKM B or EPDM o-ring. PVDF body.



**LEVEL PROBE with FOOT FILTER**  
Level probe with REED TYPER CONTACT. High temperature resistant, not influenced by viscosity, opacity, conductivity or dielectric constant (0 e 60°C).



#### CHEMICAL TANKS & SAFETY BUNDS

Chemical tanks made of polyethylene, UV resistant with safety bunds. For dosing pumps and mixers.



#### CALCIUM HYPOCHLORITE DOSING STATIONS

Our chemical tanks can be assembled with:

- 1 Dosing pump (or 2 without mixer) - 1 mixer
- 1 water loading faucet
- 1 outgassing valve
- 1 or 2 suction lances
- 1 water purging faucet
- 2 level probes with filter (without mixer)

Assembling made with two dosing pumps must use a double-suction lance and KDPV kit for connecting both the pumps.







cod. 20200920



EMEC S.r.l. Via Donatori di Sangue, 1 - 02100 Rieti - Italia

T. +39 0746 2284 1 F. +39 0746 2284 2

[info@emecpumps.com](mailto:info@emecpumps.com) - [www.emecpumps.com](http://www.emecpumps.com)