



This manual contains safety information that if ignored can endanger life or result in serious injury. They are indicated by this icon.



Keep the instrument protected from sun and water. Avoid water splashes.



OPERATING INSTRUCTIONS FOR “ WDPHCA ”

ERMES COMMUNICATION
www.ermes-server.com

Read Carefully !



ENGLISH Version

R2-06-21



NORME CE
EC RULES(STANDARD EC)
NORMAS DE LA CE

Direttiva Bassa Tensione
Low Voltage Directive
Directiva de baja tensión } 2014/35/UE

Direttiva EMC Compatibilità Elettromagnetica
EMC electromagnetic compatibility directive
EMC directiva de compatibilidad electromagnética } 2014/30/UE



GENERAL SAFETY GUIDELINES

Danger!

In emergencies the instrument should be switched off immediately! Disconnect the power cable from the power supply!

When installing always observe local regulations!

Manufacturer is not liable for any unauthorized use or misuse of this product that may cause injury, damage to persons and / or materials.

Caution!

Instrument must be accessible at all times for both operating and servicing. Access must not be obstructed in any way!

Feeder should be interlocked with a no-flow protection device to automatically shut-off the pumps when there is no flow!

Pumps and accessories must be serviced and repaired by qualified and authorized personnel only!

Always discharge the liquid end before servicing the instrument!

Empty and rinse the liquid end before work on a pump which has been used with hazardous or unknown chemicals!

Always read chemical safety datasheet!

Always wear protective clothing when handling hazardous or unknown chemicals!

Instrument must be operated / serviced by trained technicians only!

All connection operations must be performed while the instrument is not connected to main supply!

Missed activation for Min/Max alarm and Maximum Dosing Alarm may cause to hazardous overdosing!

1. Introduction

WDPHCA is a fully Integrated All-in-One Swimming Pool Controller. Ideal for new construction projects the WDPHCA innovates panel mount capability into a small wall-mount package. 2 Pumps for FLOCCULANT (anti-algae) and pH adjustment and 230 VAC output for chlorine, small-form-factor saves space, installation time, and shipping expense. Electrovalve for lambitor or chlorine generator (hydrolisys) dosing. Weekly timer for anti-algae dosing. PVDF pump heads and liquid ends

Working ranges are: pH : from 0 to 14pH
Chlorine: from 0 to 10 mg/l Cl₂

Please note about background color display (RGB Version only):

GREEN: normal working mode | **WHITE :** Standby | **RED:** Alarm (che info status)
YELLOW: Warning (check controller, ie.: delay time active)

All information are provided through a large LCD display. Using a revolutionary wheel control the instrument can be easily programmed. WDPHCA is housed in a IP65 plastic box.

2. The wheel

Located in the upper right side of WDPHCA there is a wheel that must be used to control the instrument. Wheel can be rotated in both directions to scroll over the menus and / or pressed to confirm highlighted selection / value.

NOTE: Once changes are made press "OK" to save and exit from submenu. Press "ESC" to exit without saving.

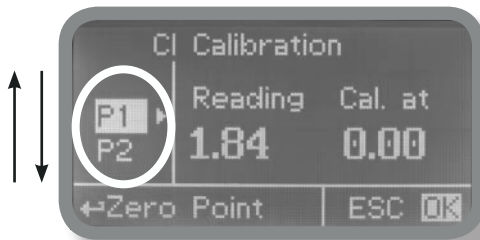

Rotate wheel to scroll through menus or options

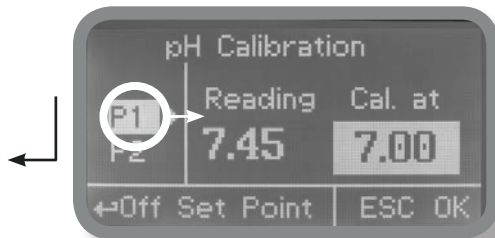

Press wheel to select highlighted option

3. Mainboard Connections

Unplug instrument from main power supply then perform connections to probes and / or selected outputs by following the above picture.

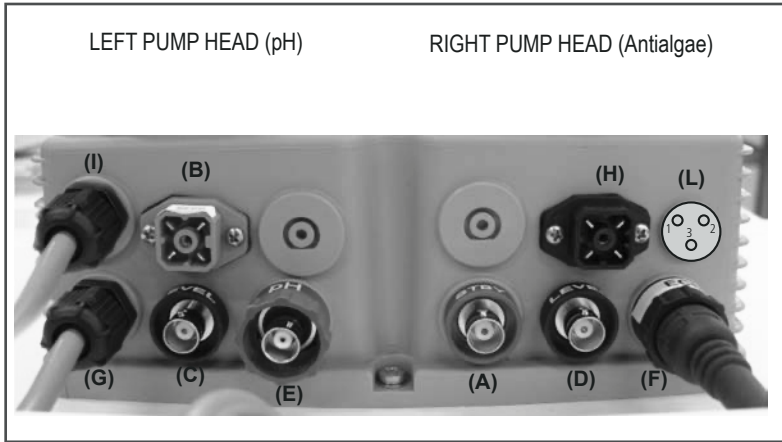

use rubber caps to protect unused outputs

(A) STAND-BY Input

(B) Flow Input**:



- 1 Blue (Ground)
- 2 Brown (+)
- 3 n/a
- 4 Black (Signal)

(C) pH Level Input (Left pump head)

(D) Cl Level Input (Right pump head)

(E) pH probe connector (i.e. EPHS)

(F) Cl probe connector (i.e. ECLx)

(G) Power Supply: 230VAC 50-60 Hz or 115VAC (see pump's label).

(H) Alarm output contact*:



- 1 n/a
- 2 Black
- 3 Red
- 4 n/a

(I) Electrovalve output 230VAC / 115VAC 50-60 Hz for chlorine

*freecontact max load 4A 250V (active when flow alarm, level, dosing problem and broken probe)

**NPED 4 contact version pin 1 and 4

(L) RS485 communication only

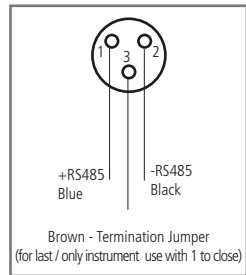

Warning: Connections must be performed by qualified and trained personnel only.

3.1 Hydraulic connections, hoses

Unplug instrument from main power supply then perform connections to probes and / or selected outputs by following the above picture. Hydraulic connections are:

Suction Hose with level probe and foot filter
Delivery Hose with injection valve
Discharge Hose

Suction Hose.

Completely unscrew tightening nut from pump's head and remove assembling components: tightening nut, holding ring and pipe holder.

Assembly as shown. Insert hose into pipe holder until it reaches the bottom.

Lock hose on pump's head by screwing down the tightening nut.
Use only hands to do it!

Connect other side of the hose to the foot filter using the same procedure.

Delivery Hose.

Completely unscrew tightening nut from pump's head and remove assembling components: tightening nut, holding ring and pipe holder.

Assembly as shown. Insert hose into pipe holder until it reaches the bottom.

Lock hose on pump's head by screwing down the tightening nut.
Use only hands to do it!

Connect other side of the hose to the injection valve using the same procedure.

Discharge hose.

Insert one side of discharge hose into pump head discharge connector.

Insert other side of discharge hose into product's tank.
During priming procedure product exceeding will flow into tank.



3.2 Hydraulic connections, level probes

Assembling foot filter with level probe. Level probe must be assembled with foot filter using the provided kit. Foot valve is made to be installed into tank's bottom without sediments priming problem.

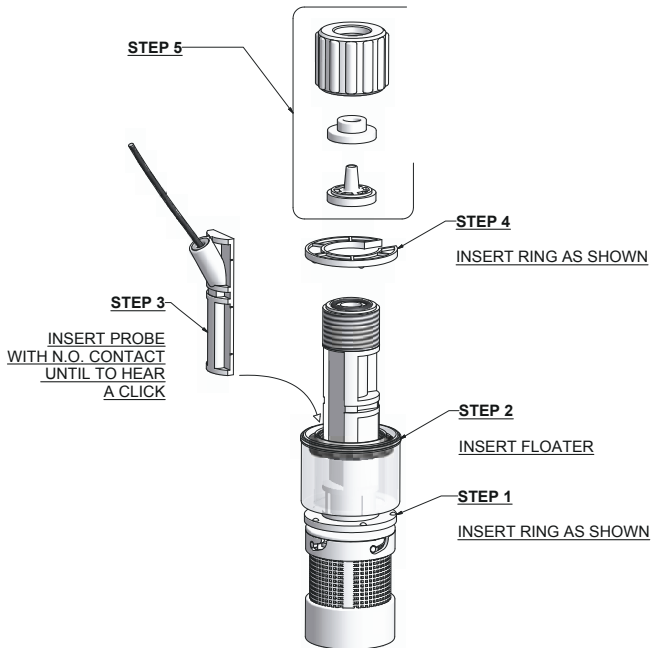

Connect BNC from level probe into WDPHCA level inputs ("B" and "E" connectors).

Put level probe assembled with foot filter into tank's bottom.

Warning: If there is a mixer installed into tank, install a suction lance instead of level probe / foot filter.

Before inserting the PVDF hoses it is advisable to heat them up, make a 90° cut and insert them all the way to the bottom of the pipe holder.

3.3 Hydraulic connections, pump heads

Injection Valve.

Injection valve must be installed on plant from water's input.
Injection valve will open at pressure greater than 0,3bar.

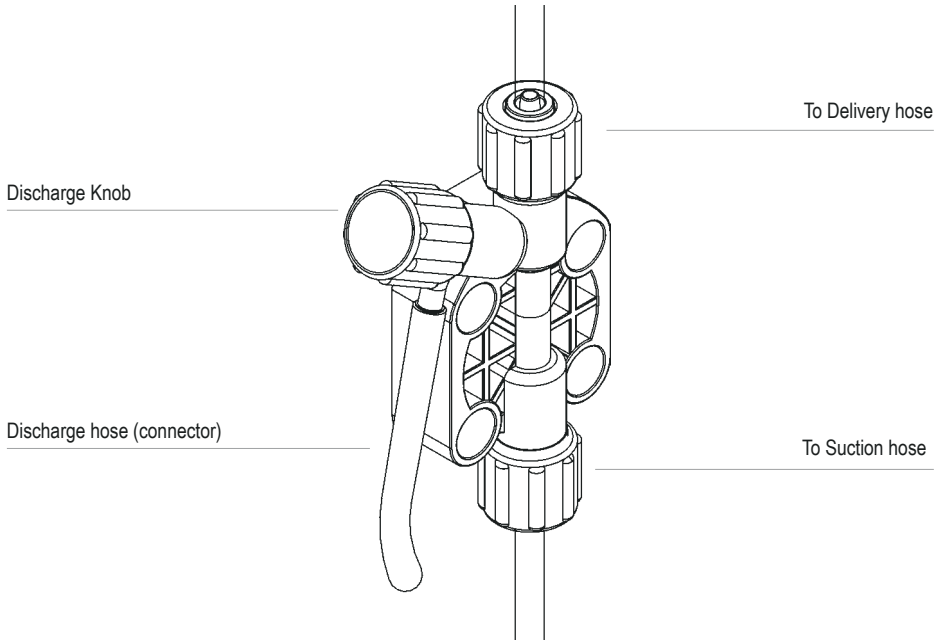

Feeder should be interlocked with a no-flow protection device to automatically shut-off the pumps when there is no flow!

Adequate measures shall be taken to prevent cross connection of chemicals!

Chemical feeding must be stopped during backwash cycles and periods of noflow as these conditions may introduce the potential for chemical overdosing. Not doing so may result in elevated chemical concentrations and hazardous gas introduction into the pool or spa.

4. Main Screen

When into normal operating mode, WDPHCA shows the following main screen:

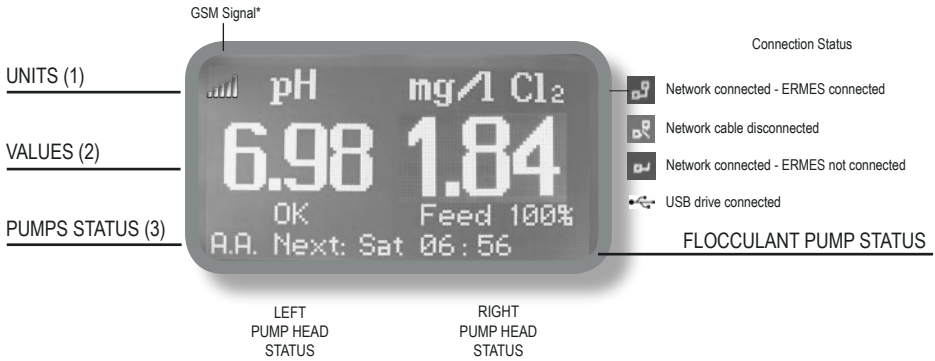

*GSM version, see ERMES communication manual for further info.

Main screen is divided into 3 zones.

- (1) UNITS. "pH" is the measuring unit for pH probe.
"mg/l" is the measuring unit for Chlorine probe.
- (2) VALUES These numbers are values read by the probes.
- (3) PUMPS STATUS These fields are related to current pumps status and instrument activity.
- (4) ANTIALGAE* Flocculant pump weekly dosing activity (right pump head)

DISPLAY	EXPLANATION	WHAT TO DO IF OCCURS
FEED ON / Anti Algae Feed On	Pump is dosing chemical product.	No action required.
FEED OFF	Pump is OFF.	No action required.
LOW TANK	Chemical product tank is almost empty.	Check chemical tank. Restore correct level.
NO FLOW	External flow contact stops both the pumps.	Check flow.
OK	Setpoint reached.	No action required.
FEED LIMIT	Time for dosing exceeded. Dosing alarm.	Check pump dosing capacity.
PROBE FAIL	Stuck reading values.	Check probe for proper functioning.
DELAY	Pump activity delayed. Countdown in progress.	If not requested check PARAMETERS options.
WAIT PH	pH priority dosage over Cl dosage.	If not requested check PRIORITY options.
A.A. NEXT	Next weekly dosing activity.	No action required.

5. Quick status check

From main screen rotate the wheel to review main instrument parameters and current status conditions.

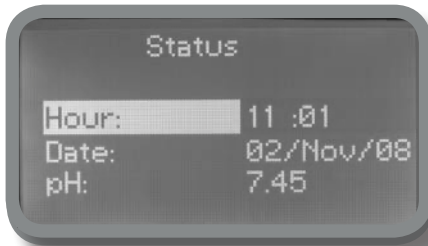

Current time
Today date
Current pH reading



Current Chlorine reading
Dosing alarm condition
Probe failure status
NO FLOW contact status

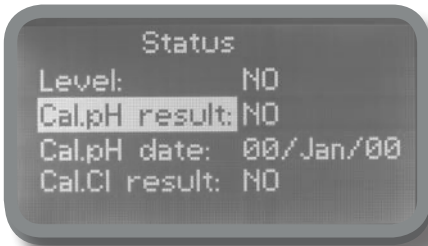

Tank Level status
Last pH calibration result
Last pH calibration date
Last Cl calibration result

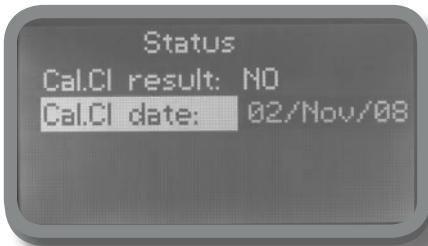

Last Cl calibration date

6. Password

To grant access into "Main Menu" press the wheel from main screen and enter the passcode.

If this is the first time here then the passcode is 0000 (factory preset). Press wheel 5 times to enter into "Main Menu".

Otherwise press the wheel 1 time and enter the passcode. Numbers can be selected rotating the wheel.

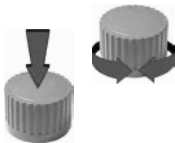

To set a new passcode choose "PARAMETERS" from "Main Menu", move on "New Pcode", click on wheel and enter a four numbers code. Click on "EXIT" and choose "YES" to save request. The new passcode is now ready.

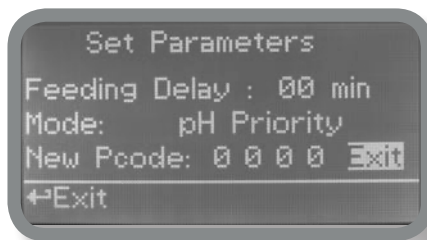
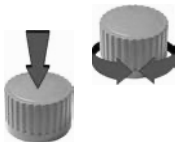









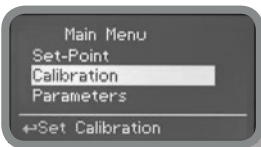

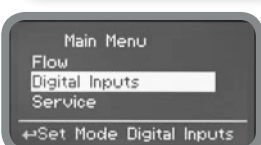

Lost passcode ?

Please don't forget the passcode (if changed). In the unfortunate event, please call your local distributor for unlocking procedure. There is no way for you to recover lost passcode.

7. “Main Menu” list

To grant access into “Main Menu” enter the passcode (as described in previous chapter). Once into “Main Menu” rotate the wheel to scroll through all the options available.

		“Set-Point” (page 12)
		“Probe Calibration” (page 17)
		“Parameters” (page 20)
		“Pumps Activities” (page 21)
		“Instrument Reset” (page 22)
		“Max Strokes Settings” (page 22)
		“Dosing Alarm” (page 24)
		“International” (page 25)
		“Probe Failure” (page 26)
		“Flow” (page 27)
		“Digital Inputs” (page 28)
		“Service” (page 27)
		“Log Setup” (page 29)
		“RS485 Setup” (page 30)
		“SMS Menu” (page 30)
		“TCP/IP” (page 31)
		“GPRS” (page 32)
		“Email” (page 32)
		“Log View” (page 29)
		“Timer Week” (page 35)
		“pH Compensation” / “Disinfectant” ECL1 or ECL6 probes only (page 34/ 35)

8. "Set-Point", pH (on/off)

pH reading values can be set to operate the pH pump using 2 set-points into **On/Off mode** or **Proportional (%)**.

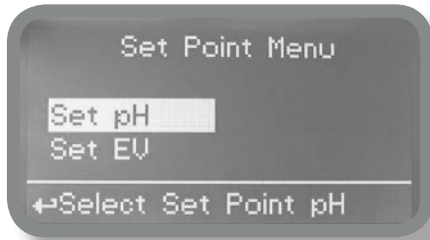

On/Off mode set the instrument to operate using two set values that enable or disable the pH pump. To use this mode move cursor on "Working Mode". Press the wheel and select it.

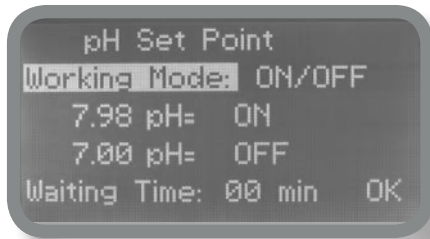
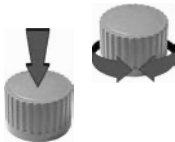

ON/OFF mode while dosing ALKALI

Set pH value at 7.00 OFF and 6.90 ON.

Instrument will leave the pH pump active until reading value will increase up to 7.00pH.

At 7.00pH the pH pump will be disabled until reading value will decrease under 6.90pH.

Waiting Time: to let pump operate at pulses per minutes add one or more minute (1pulse every xx minutes). Otherwise (00 minutes) pump will operate at set stroke settings (see page 22).

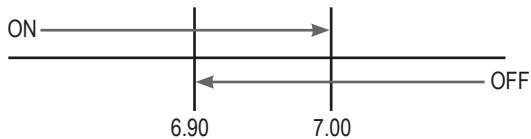

8.1 "Set-Point", pH (on/off)

ON/OFF mode while dosing ACID

Set pH value at 7.00 OFF and 7.10 ON.

Instrument will leave the pH pump active until reading value will decrease up to 7.00pH

At 7.00pH the pH pump will be disabled until reading value will increase up to 7.10pH.

Waiting Time: to let pump operate at pulses per minutes add one or more minute (1pulse every xx minutes). Otherwise (00 minutes) pump will operate at set stroke settings (see page 22).

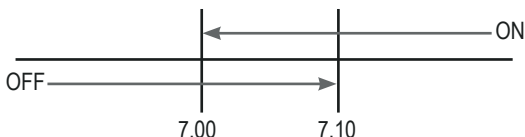

Do you know ?

In chemistry, an alkali is a basic, ionic salt of an alkali metal or alkaline earth metal element. Alkalis are best known for being bases (compounds with pH greater than 7) that dissolve in water. The adjective alkaline is commonly used in English as a synonym for base, especially for soluble bases. This broad use of the term is likely to have come about because alkalis were the first bases known to obey the Arrhenius definition of a base and are still among the more common bases. Since Brønsted-Lowry acid-base theory, the term alkali in chemistry is normally restricted to those salts containing alkali and alkaline earth metal elements.

An acid (often represented by the generic formula HA [H^+A^-]) is traditionally considered any chemical compound that, when dissolved in water, gives a solution with a hydrogen ion activity greater than in pure water, i.e. a pH less than 7.0. That approximates the modern definition of Johannes Nicolaus Brønsted and Martin Lowry, who independently defined an acid as a compound which donates a hydrogen ion (H^+) to another compound (called a base). Common examples include acetic acid (in vinegar) and sulfuric acid (used in car batteries). Acid/base systems are different from redox reactions in that there is no change in oxidation state.

8.2 “Set-Point”, pH (proportional)

pH reading values can be set to operate the pH pump using 2 set-points into **On/Off mode** or **Proportional (%)**.

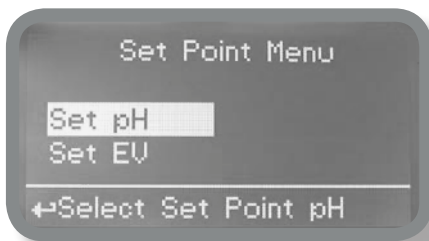

Proportional mode set the instrument to operate using a calculated percentage between two set values that enable or disable the pH pump. To use this mode move cursor on “Working Mode”. Press the wheel and select it.

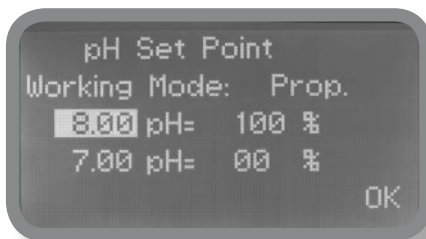
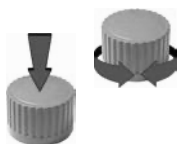

PROPORTIONAL mode between 7pH(0%) and 8pH (100%). [Stroke setting 180]

In this mode the pH pump will be “ON” for values greater than 8pH with maximum set strokes capacity (e.g.: 180) and it'll be “OFF” for values lower than 7pH. For values of 7.5pH pump will be “ON” with 90 strokes capacity. The calculation is based on 180 strokes setting (see page 22).

8.5 "Set-Point", EV (on/off)

Cl reading values can be set to operate EV output using 2 set-points into **On/Off mode** or **Proportional (%)**.



On/Off mode set the instrument to operate using two set values that enable or disable the electrovalve output. To use this mode move cursor on "Working Mode". Press the wheel and select it.

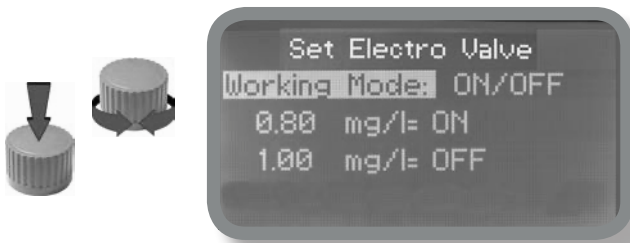

ON/OFF mode

Set Cl value at 0.80 mg/l ON and 1.00 mg/l OFF. The difference between the two Cl values is called **HYSTERESIS**. Instrument will enable the electrovalve output when reading value will decrease at 0.80mg/l. At 0.80mg/l the electrovalve output will be enabled until reading value will increase at 1.00mg/l.

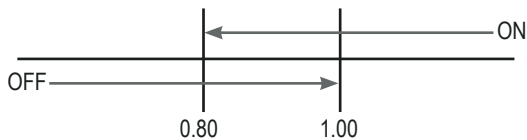

8.6 "Set-Point", EV (proportional) - for electrovalve version only

Cl reading values can be set to operate the electrovalve output using 2 set-points into **On/Off mode** or **Proportional (%)**.



Proportional mode set the instrument to operate using a calculated percentage between two set values that enable or disable the electrovalve output. To use this mode move cursor on "Working Mode". Press the wheel and select it.



PROPORTIONAL MODE between 1.00mg/l (0%) and 0.50mg/l(100%). [100 seconds time basis]

Set first value: 0.50mg/l = 100% and second value: 1mg/l = 0%.

For reading values ≥ 1 then the EV output will be always OFF.

For reading values ≤ 0.50 then the EV output will be always ON.

For reading values of 0,875 then the output will be OFF for 25 seconds, ON for 75 seconds.

For reading values of 0.75 then the output will be OFF for 50 secondi, ON for 50 seconds.

9. "Probe Calibration", pH

pH calibration procedure involves two calibration points and it requires two buffer solutions. Default buffer solutions are pH 4.00 and pH 7.00. pH reading value can be also 30°C temperature compensated from "pH compensation" menu. From "Menu Calibration" choose "pH probe".



In the following example instrument will calibrate pH using default buffer solutions values.

Note: this procedure assumes that instrument is correctly configured and a working pH probe connected. Otherwise unattended results may occur.

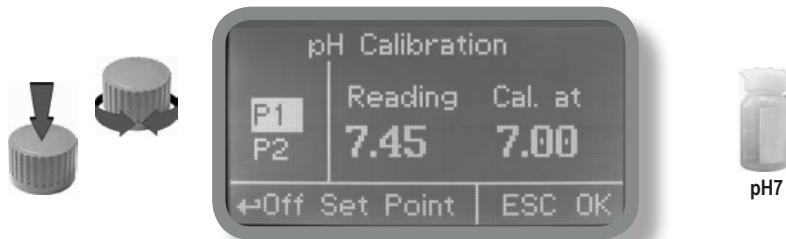

Calib 1st Point.

Once into "pH Calibration" menu move wheel on "P1" then press wheel to enter into first point calibration submenu. Prepare 7.00pH buffer solution and dip probe's sensor on it. Wait until reading value is stable and according to buffer solution value move wheel until it is the same on display ("Cal. at" field). Default value is 7.00pH.

Note: buffer solution value may change if environment temperature it's different than 20°C. Read solution's label for more information. According to this occurrence "pH Default" must be changed.

Power Supply calibration ?

To obtain the most reliable results during pulses calculation is possible to calibrate power supply read value. Press wheel on "P1" then move cursor on "OK" and confirm power supply read value. (e.g.: 230V).

9. "Probe Calibration", pH



Calib 2nd Point.

Move wheel on "P2" then press wheel to enter into second point calibration submenu. Prepare 4.00pH buffer solution and dip probe's sensor on it. Wait until reading value is stable and according to buffer solution value move wheel until it is the same on display ("Cal. at" field). Default value is 4.00pH.

Note: buffer solution value may change if environment temperature it's different than 20°C. Read solution's label for more information. According to this occurrence "pH Default" must be changed.

9.1 "Probe Calibration", Cl

Cl calibration procedure involves probe's selection, Zero (P1) and 2nd Point (P2) calibration. From "Menu Calibration" choose "Cl probe".

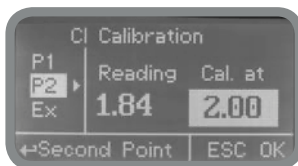
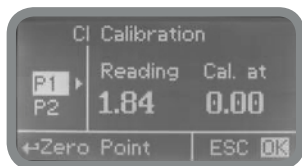

Note: This procedure assumes that instrument is correctly configured and a working Chlorine probe connected and installed on system. Measurement must be performed using plant water. Otherwise unattended results may occur.

Calib Zero (P1).

Once into "Cl calibration" menu move on "P1" then press wheel to enter into calibration mode. For a correct system calibration proceed as follows.

- install an "activated carbon filter" prior to probe's holder.
- let system water flow into probe holder for about 30 minutes.
- press wheel (cursor must be on "Cal.at"). Remove filter.



Carbon Filter System

Calib 2nd point (P2).

"P2": "slope" calibration. Before to proceed, wait up to half hour (until the probe become operative).

Now move on "P2" then press wheel to enter into calibration mode.

For a correct system calibration use a Photometer / DPD device to read chlorine. Enter value using the wheel then move cursor on "OK". Now press the wheel.

To end procedure move cursor on "OK" and press wheel to proceed to "Save" request screen. Move wheel on "YES" to save or "NO" to discard changes. If an error occurred during calibration procedure then the instrument will show an error message and will ask to proceed to a new calibration, cancel current operation or restore default settings.



Photometer

10. "Parameters"

From "Menu Calibration" choose "Parameters". This menu allows to set a delay (max 60 minutes) before pumps begin to feed. Furthermore use this menu to set pH pump startup priority and to change default passcode.



Feeding Delay.

Move on "Feeding Delay" then press wheel. Choose a value between 0 (disabled) and 60 minutes (maximum delay time). This feature can be used to accord a startup delay for the pumps. Delay occurs when instrument is powered or after a "NO FLOW" contact recovery.

Mode.

Move on "Mode" then press wheel. If both pumps need to operate, a startup priority can be set to allow the pH pump to begin to feed prior to CI pump. Choose "pH priority" to enable this function. CI pump will begin to dose when pH pump has stopped.

New Pcode.

See page 10.

11. "Pumps Activities"

From "Menu Calibration" choose "Pumps activities". This menu allows to manually operate one or both the pumps for a settable time.

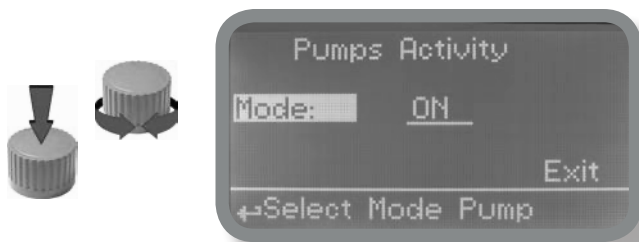

Move on "Mode" then press wheel. Choose "Man. Pump1" for manually operate pH pumps or "Man. Pump2" for CI pump.

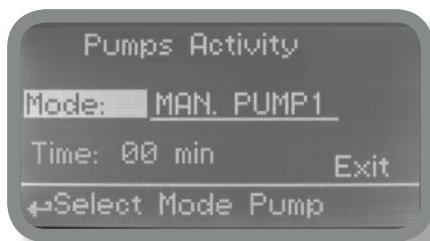

Press wheel to move cursor on "TIME" field. Once here, choose a working time between 0 (disabled) or 199 minutes. Move on "EXIT", then press wheel.

Exit from main menu. Main display will show a countdown including the selected pump (left for pH pump, right for CI pump). To stop this countdown go back to "Pump activities" menu and choose "ON" as working mode or wait until countdown ends. **This function can be used for priming purposes.**

12. "Instrument Reset"

To restore instrument to its default values (including password) once into "Instrument Reset" menu, press wheel then change value to "ON", press wheel again, move on "OK" then finally press wheel. The instrument display will show "CHECKSUM ERROR". Press wheel to return into "Main Menu". Move on "EXIT", then press wheel. The instrument is now restored to factory default. Please repeat all calibration procedures and programming parameters.



13. "Max strokes settings"

pH and Cl pumps can be set to operate within a maximum number of strokes. Strokes are the total amount of injections per minute made by a pump. Using wheel choose a value for one or both pumps then move on "EXIT".

To end procedure move cursor on "OK" and press wheel to proceed to "Save" request screen. Move wheel on "YES" to save or "NO" to discard changes.



Note: Pumps dosing capacity is based on 180 strokes per minutes

14. Anti algae pump test

Flocculant pump (right) works always at max pulses. This test defines the cc quantity (cubical centimeters) that the pump feed every single injection so to know the cc/stroke. To determine this value the pump must be calibrated. Install the pump on plant and insert the suction hose (with its foot filter) into a BEKER "test-tube" (1ml = 1cc). If pump's model is self-priming put the discharge hose into the "test-tube" too. From menu "PUMP ACTIVITY" (p. 21) set Mode on "TEST". Save and exit from main menu.

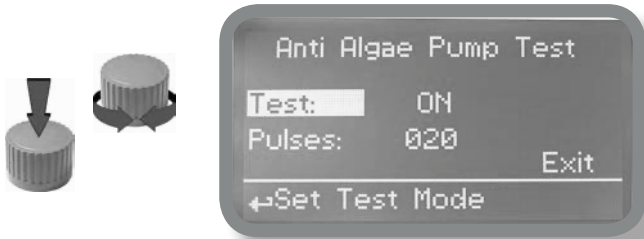

Fill up the "test-tube" with the chemical until to reach a known value.

Set "Test: ON" in "Anti Algae Pump Test" and define a number of pulses the pump will produce during the procedure. Insert pump delivery hose into a "Test- tube". Exit from main menu. The pump will begin to produce the set pulses.



At the end read the chemical value left into the "test-tube". Subtract the initial value to the left value.

Divide the result with the Pulses value set. Type this value (cc/s) into "ANTI ALGAE PUMP SETTINGS" menu: cc/s number and grams to dose. Save and exit. Then set Mode on "AUTO". Save and exit from main menu.



15. "Dosing Alarm"

Use this menu to assign a maximum time to the pumps for reaching the setpoint. If set time ends and the pumps are still dosing, within this menu is possible to STOP them or just to show an alarm message. Function can be disabled selecting "OFF" instead of a number (minutes). Dosing alarm can be set for both or just one pump.



E.g. To set CI pump to stop after time ends and setpoint isn't still reached press wheel, choose maximum time, press wheel move on next field and choose "STOP". Time can be set between 0 and 100 minutes. When satisfied with settings move on exit and press wheel.

16. "International"

Use this menu to set international parameters as UNIT FORMAT (Europe IS or USA), Local Time, Date and system language..



Format.

Use this option to use European or USA units format. See table for differences.

EUROPE IS (International Standard)	USA
Date (DD/MMM/YY)	Date (MMM/DD/YY)
Time 24h	Time AM / PM

Time.

Use this option to set local time.

Date.

Use this option to set date.

Language.

Use this option to change system language.

Move on exit to end changes.

17. "Probe Failure"

Use this menu to assign a maximum time to connected probes to stay stuck. A stuck probe (it remains on same value for some time) means that probably probe itself is damaged. Within this menu is possible to STOP pumps or just to show an alarm message (probe failure) . Function can be disabled selecting "OFF" instead of a number (minutes). This function can be set for both or just one probe.

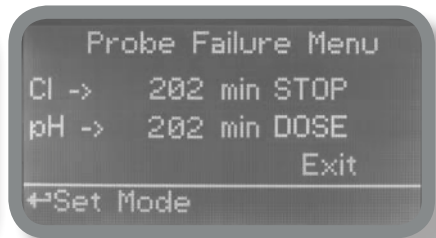

E.g. To set CI pump to stop after time ends and probe doesn't change reading values press wheel, choose maximum time, press wheel move on next field and choose "STOP". Time can be set between 100 and 254 minutes. When satisfied with settings move on exit and press wheel.

18. "Flow Contact"

Flow contact (locate connection on page 4) can be enabled to stop all dosing activities using a DIRECT contact (N.O. normally opened contact) or REVERSE contact (N.C. normally closed contact). Move wheel for enabling and changing contact logic (DIRECT or REVERSE). Furthermore "Flow contact" can start after a specified time when contact status changes. To set it move wheel on "Time:00 min", click it and rotate to choose time (from 0 to 99 minutes). Confirm selection by clicking wheel.

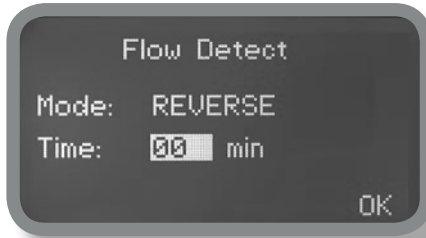
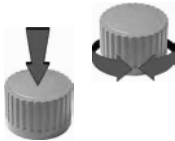

19. "Service"

This "view only" menu shows probes reading live. Press "ESC" to exit.

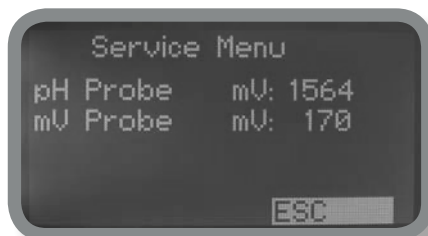

20. "Digital Inputs" - Contact mode for inputs

This function sets contact type for each digital input. Contact type can be set as N.O. (normally open contact) or N.C. (normally closed contact). Using the wheel move on required input, press wheel then rotate the wheel to choose between N.O. or N.C.



21. "LOG SETUP" - Activites log setup

This function records instrument acitivity (date, hour, temperature, uS, totalizer I/O, alarms, outputs). It starts for selected frequency period (every) at requested time (time).



Set ACTIVE to "enabled" to activate log recording.

TIME: recording start time (time format 23h e 59min)

EVERY: recording frequency (time format 23h e 59min)

Note: advanced log control (graph, printing, comparison tables, event filtering, etc) is available through "ERMES Communication Software" for PC.

See "ERMES Communication Software" manual for proper PC software configuration.

22. "LOG VIEW" - Activities log viewer

To see alarm log entries as set on log menu choose "log view" on main menu.

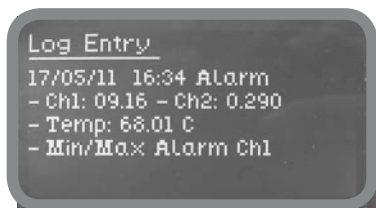

SET DATE & TIME BEFORE TO ENABLE LOG. IF NOT POWERED FOR ABOUT 30 DAYS THE INSTRUMENT WILL LOOSE DATE/TIME

23. "RS485" - Communication port setup

Prior to install the instrument into an RS485 local system a unique ID NUMBER (from 1 to 30) and ID NAME (station name) must be set. Rotate wheel and edit fields. If ID number has already assigned an error message will follow after ID Check (move cursor on CHECK and press wheel). In this event try using another number.



24. "SMS Menu"

Instrument may remotely send SMS alarm messages using its own modem (sold as option). It can be configured as follows:

SMS1 / SMS2 /SMS3.

Using the wheel enter a mobile phone that will receive alert SMS messages if something wrong occurs. SMS number must be set using local number format. For example : 3391349134 will send an SMS message to mobile phone. Log level (and SMS frequency alert) may be set using options in "ACTIVE MSG" within "GSM menu".



- TO AVOID UNDESIRED MESSAGES USE CAREFULLY LOG SETUP -

- WARNING: THIS FUNCTION COULD NOT BE FREE OF CHARGE. DEPENDING ON YOUR OPERATOR CONTRACT IT COULD GENERATE PAYING SMS TRAFFIC !

25. "TCP/IP" - LAN setup

The instrument may be remotely operated using a standard ethernet connection (sold as option). A static or dynamic IP address and a CAT5 ethernet cable is required. According to your network capacity connection speed is 10/100Mbps. To obtain a valid IP address and subnet mask contact your net administrator. Enter parameters and move cursor on "SAVE" to store parameters then move on "OK" and press wheel to save and activate configuration.

Based on your network configuration choose to obtain network parameters automatically (DYNAMIC) or manually (STATIC).



See "ERMES Communication Software" manual for proper PC software configuration.

What is a static IP address/dynamic IP address?

A static IP address is a number (in the form of a dotted quad) that is assigned to a computer by an Internet service provider (ISP) to be its permanent address on the Internet. Computers use IP addresses to locate and talk to each other on the Internet, much the same way people use phone numbers to locate and talk to one another on the telephone. When you want to visit whatis.com, your computer asks a domain name system (DNS) server (think telephone information operator) for the correct dotted quad number (think phone number) for whatis.com and your computer uses the answer it receives to connect to the whatis.com server. It would be simple if every computer that connects to the Internet could have its own static IP number, but when the Internet was first conceived, the architects didn't foresee the need for an unlimited number of IP addresses. Consequently, there are not enough IP numbers to go around. To get around that problem, many Internet service providers limit the number of static IP addresses they allocate, and economize on the remaining number of IP addresses they possess by temporarily assigning an IP address to a requesting Dynamic Host Configuration Protocol (DHCP) computer from a pool of IP addresses. The temporary IP address is called a dynamic IP address.

Requesting DHCP computers receive a dynamic IP address (think temporary phone number) for the duration of that Internet session or for some other specified amount of time. Once the user disconnects from the Internet, their dynamic IP address goes back into the IP address pool so it can be assigned to another user. Even if the user reconnects immediately, odds are they will not be assigned the same IP address from the pool. To keep our telephone analogy going, using a dynamic IP address is similar to using a pay phone. Unless there is a reason to receive a call, the user does not care what number he or she is calling from.

There are times, however, when users who connect to the Internet using dynamic IP wish to allow other computers to locate them. Perhaps they want to use CU-SeeMe or use a VoIP application to make long distance phone calls using their IP connection. In that case, they would need a static IP address. The user has two choices; they can contact their ISP and request a static IP address, or they can use a dynamic DNS service. Either choice will probably involve an additional monthly fee.

Using a dynamic DNS service works as if there was an old-fashioned telephone message service at your computer's disposal. When a user registers with a DNS service and connects to the Internet with a dynamic IP address, the user's computer contacts the DNS service and lets them know what IP address it has been assigned from the pool; the service works with the DNS server to forward the correct address to the requesting DHCP computer. (Think of calling the message service and saying "Hi. I can be reached at 435.44.32.111 right now. Please tell anyone who tries to reach me to call that number.) Using a dynamic DNS service to arrange for computers to find you even though you are using a dynamic IP address is the next-best thing to having a static IP.

26. "GPRS" - Mobile setup

Instrument may be remotely operated using an embedded standard GPRS modem (sold as option). In order to activate this service please ensure that the following steps are correctly completed:

- Make certain the antenna location is not shielded by metal objects or near sources of electrical 'noise'.
- Make certain the distance from the antenna to the "Instrument" unit is within cable length.
- Do not route the cable where it could be pinched in doors, windows etc.
- Ensure that SIM into "Instrument" modem is correctly inserted, activated and within operator range.
- insert SIM phone number into Phone Number menu



See "ERMES Communication Software" manual for proper PC software configuration.

Instrument can be set for automatic configuration (Configuration option set to "Automatic") or manually (Configuration option set to "Manual") based on your SIM data access parameters. For manual configuration option enter APN (access point name) and SIM phone number. Move wheel on "OK" to save and move on "ESC" to go back to main menu.

WARNING: THIS FUNCTION COULD NOT BE FREE OF CHARGE. DEPENDING ON YOUR OPERATOR CONTRACT IT COULD GENERATE PAYING DATA TRAFFIC !

27. "Email" - Email setup for sending alarm / activity

If Ethernet module or GPRS module is installed (sold as option) the instrument can be configured to send email alarm messages up to two recipients. Click on "Email 1" or "Email 2" and enter email address.

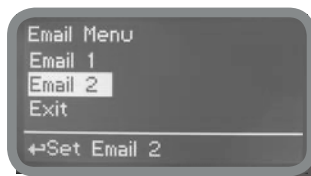

Access point name (APN) identifies an IP packet data network (PDN), that a mobile data user wants to communicate with. In addition to identifying a PDN, an APN may also be used to define the type of service, (eg connection to wireless application protocol (WAP) server, multimedia messaging service (MMS)), that is provided by the PDN. APN is used in 3GPP data access networks, eg general packet radio service (GPRS), evolved packet core (EPC).

28. MDCL1 probe module

Located into upper side of mainboard there are two connectors that can be used to install probe modules. Modules come pre-installed upon request and may appear different as shown (different configurations). Identify installed modules to correctly connect probes.

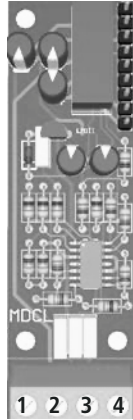

Module suitable for:

ECL1
ECL2
ECL3
ECL8
ECL9
ECL10
ECL11
ECL17
ECL18

Connect probe as follows:

Block n.1 : V+
Block n.2 : V-
Block n.3 : IN
Block n.4 : GND

MDCL1 probe series probe module require to enable or disable pH compensation based on temperature and / or Cl compensation based on pH. Within "Main menu", select "Compensation" then press wheel then choose "ON". To disable compensation choose "OFF". Compensation are both independent. Changes into this menu requires to recalibrate probe.

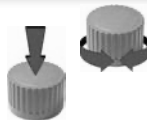
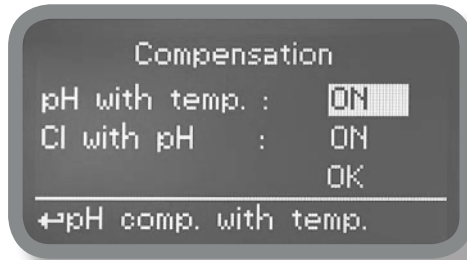

29. MDCL6 probe module

Located into upper side of mainboard are two connectors that can be used to install probe modules. Modules come pre-installed upon request and may appear different as shown (different configurations). Identify installed modules to correctly connect probes.

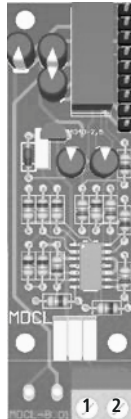

Module suitable for:

ECL4
ECL5
ECL6
ECL7
ECL12

1. GND
2. IN

MDCL6 probe series probe module require to enable or disable pH compensation based on temperature and / or Cl compensation based on pH. Within "Main menu", select "Compensation" then press wheel then choose "ON". To disable compensation choose "OFF". Compensation are both independent. Changes into this menu requires to recalibrate probe.

"Disinfectant" (ECL6 probe)

To change disinfectant product type (chlorine based or bromine based) press wheel then move wheel to change "BROMINE" or "CHLORINE" then press wheel again.

Note: this changes affect main screen UNIT display [Br2 or Cl2].



30. "Weekly Timer Settings"

Use this menu to program a weekly dosing mode for flocculant.
Set starting day (DAY) and time (HOUR) for flocculant dosing.

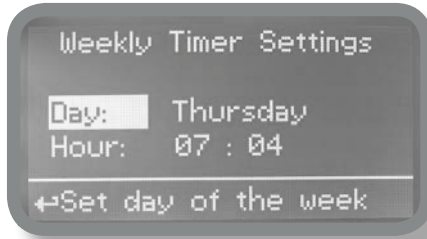

If any problem occurs during weekly dosing, refer to the following table:

TROUBLESHOOTINGS	
Mains supply interrupted.	If mains is restored within dosing activity day, dosing activity program will continue until finished. If mains is not restored within dosing activity day, dosing activity program will be stopped.
Dosing activity program over 00:00	Any dosing activity program will be stopped at 00:00.
Level alarm	Dosing activity program will be stopped. If product level is restored, dosing activity program will continue until finished.

31. Board connections

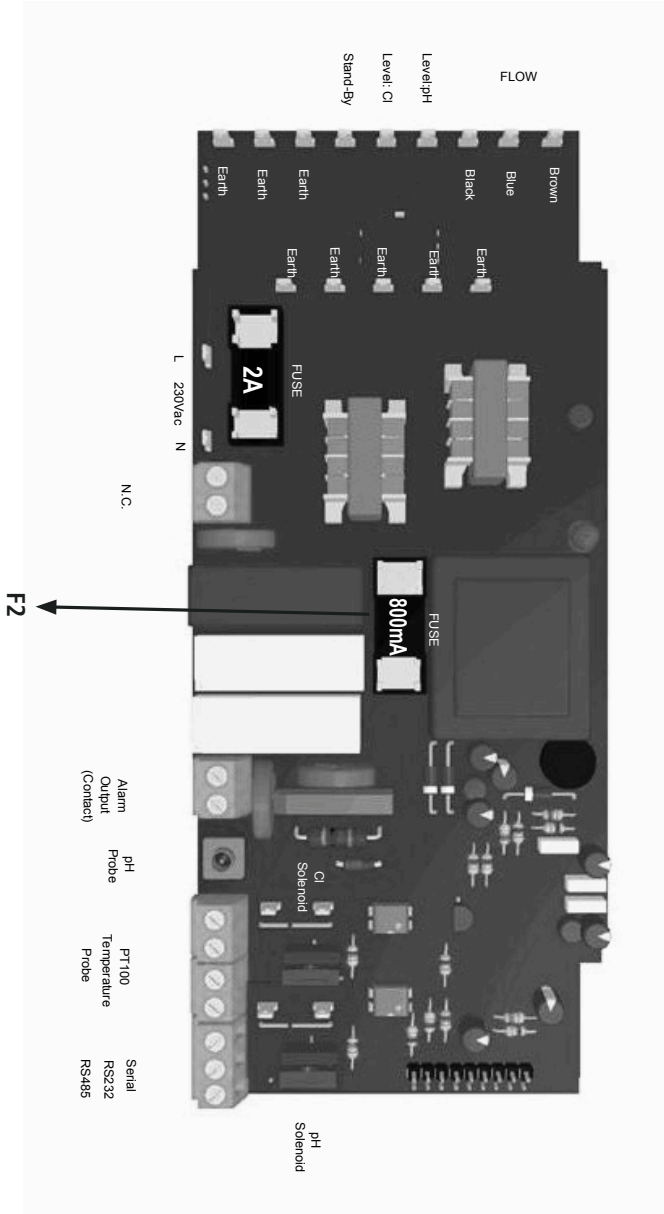

Information on this manual may contain technical inaccuracies or typographical errors. The information contained may be changed at any time without prior notification or obligation.

32. Dimensions.

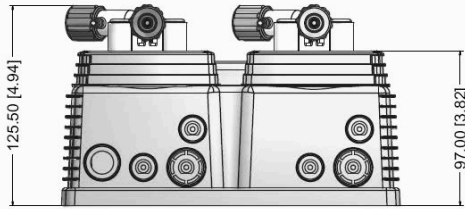

mm [inches]

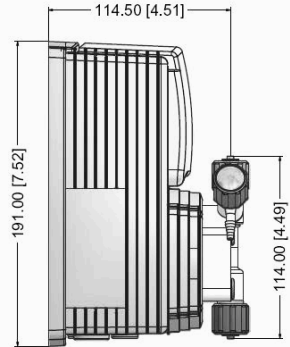
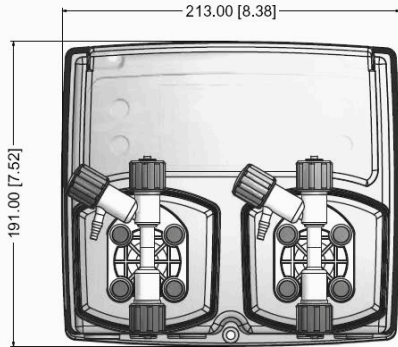

WARNING
IF EQUIPMENT IS SUPPLIED WITH A PLUG:

If an appliance coupler or separable plug is used as the disconnecting device, it shall be readily identifiable and easily reached by the operator. For single-phase portable equipment, a plug on a cord of length not greater than 3m is considered to be easily reached.



WARNING
IF EQUIPMENT IS NOT SUPPLIED WITH A PLUG:

- a) a switch or circuit-breaker shall be included in the building installation
- b) it shall be in close proximity to the equipment and within easy reach of the operator
- c) it shall be marked as the disconnecting device for the equipment

**Information on this manual may contain technical inaccuracies or typographical errors.
The information contained may be changed at any time without prior notification or obligation.**

33. Technical information.

pH range: 0 +14 ; Cl range: 0+10 mg/l
 Pump Strokes: 0 + 180
 Suction Height: 1,5 metres
 Environment Temperature: -10 + 45°C (14 + 113°F)
 Chemical Temperature: 0 + 50°C (32 + 122°F)
 Installation Class: II
 Pollution Level: 2
 Audible Noise (single head): 74dba
 Packaging and Transporting Temperature: -10 + 50°C (14 + 122°F)
 Protection degree: IP 65

Product	Formula	Ceram.	PVDF	PP	PVC	SS 316	PMMA	Hastel.	PTFE	FPM	EPDM	NBR	PE
Acetic Acid, Max 75%	CH3COOH	2	1	1	1	1	3	1	1	3	1	3	1
Hydrochloric Acid, Concentrate	HCl	1	1	1	1	3	1	1	1	1	3	3	1
Hydrofluoric Acid 40%	H2F2	3	1	1	2	3	3	2	1	1	3	3	1
Phosphoric Acid, 50%	H3PO4	1	1	1	1	2	1	1	1	1	1	3	1
Nitric Acid, 65%	HNO3	1	1	2	3	2	3	1	1	1	3	3	2
Sulphuric Acid, 85%	H2SO4	1	1	1	1	2	3	1	1	1	3	3	1
Sulphuric Acid, 98.5%	H2SO4	1	1	3	3	3	3	1	1	1	3	3	3
Amines	R-NH2	1	2	1	3	1	-	1	1	3	2	3	1
Sodium Bisulphite	NaHSO3	1	1	1	1	2	1	1	1	1	1	1	1
Sodium Carbonate (Soda)	Na2CO3	2	1	1	1	1	1	1	1	2	1	1	1
Ferric Chloride	FeCl3	1	1	1	1	3	1	1	1	1	1	1	1
Calcium Hydroxide (Slaked Lime)	Ca(OH)2	1	1	1	1	1	1	1	1	1	1	1	1
Sodium Hydroxide (Caustic Soda)	NaOH	2	1	1	1	1	1	1	1	2	1	2	1
Calcium Hypochlor (Chlor.ted Lime)	Ca(OCl)2	1	1	1	1	3	1	1	1	1	1	3	1
Sodium Hypochlorite, 12.5%	NaOCl + NaCl	1	1	2	1	3	1	1	1	1	1	2	2
Potassium Permanganate, 10%	KMnO4	1	1	1	1	1	1	1	1	1	1	3	1
Hydrogen Peroxide, 30% (Perydrol)	H2O2	1	1	1	1	1	3	1	1	1	2	3	1
Aluminium Sulphate	Al2(SO4)3	1	1	1	1	1	1	1	1	1	1	1	1
Copper-II-Sulphate (Roman Vitriol)	CuSO4	1	1	1	1	1	1	1	1	1	1	1	1

Resistance rating: (1: Resistant) ; (2: Fairly resistant) ; (3: Not resistant)

Polyvinylidene fluoride (PVDF) Pump Heads, valves, fitting, tubing

Polypropylene (PP) Pump Heads, valves, fitting, level floater

PVC Pump Heads

Stainless steel (SS 316) Pump Heads, valves

Polymethyl Metacrilate (Acrylic) PMMA Pump Heads

Hastelloy C-276 Injection valve spring

Polytetrafluoroethylene (PTFE) Diaphragm

Fluorocarbon (Viton® B) Sealings

Ethylene propylene (EPDM) Sealings

Nitrile (NBR) Sealings

Polyethylene (PE) Tubing

INDEX

CE conformity declaration	page 2
Safety information.....	page 2
Introduction.....	page 3
The wheel.....	page 3
Connections.....	page 4
Hoses	page 5
Level probes.....	page 6
Pump Heads.....	page 7
Main screen.....	page 8
Status	page 9
Password.....	page 10
“Main menu”	pag. 11
“Set point” pH (ON/OFF)	pag. 12
“Set point” pH (Proportional).....	pag. 14
“Set point”, EV (ON/OFF)	pag. 15
“Set point”, EV (Proportional)	pag. 16
“Probe Calibration”, pH - Probe calibration, pH.....	pag. 17
“Probe Calibration”, Cl - Probe calibration, Cl	pag. 19
“Parameters”.....	pag. 20
“Pump Activities”	pag. 21
“Instrument Reset”	pag. 22
“Max Strokes settings”	pag. 22
“Calibrazione CC/S”	pag. 23
“Dosing Alarm”.....	pag. 24
“International”	pag. 25
“Probe Failure”.....	pag. 26
“Flow”.....	pag. 27
“Service”	pag. 27
“Digital Inputs”	pag. 28
“LOG Setup”	pag. 29
“LOG View”.....	pag. 29
“RS485”.....	pag. 30
“SMS Menu”	pag. 30
“TCP/IP”.....	pag. 31
“GPRS”	pag. 32
“Email”	pag. 32
“pH Compensation”	pag. 33
“Disinfectant”.....	pag. 34
“Weekly Timer Settings”.....	pag. 35
Board connections.....	page 36
Dimensions.....	page 37
Technical Information.....	page 38



Disposal of end-of-life equipment by users

This symbol warns you not to dispose of the product with normal waste. Respect human health and the environment by giving the discarded equipment to a designated collection center for the recycling of electronic and electrical equipment. For more information visit the online site.



When dismantling a pump please separate material types and send them according to local recycling disposal requirements. We appreciate your efforts in supporting your local Recycle Environmental Program. Working together we'll form an active union to assure the world's invaluable resources are conserved.