

Chlorine Dioxide Generator LOTUS MAXI

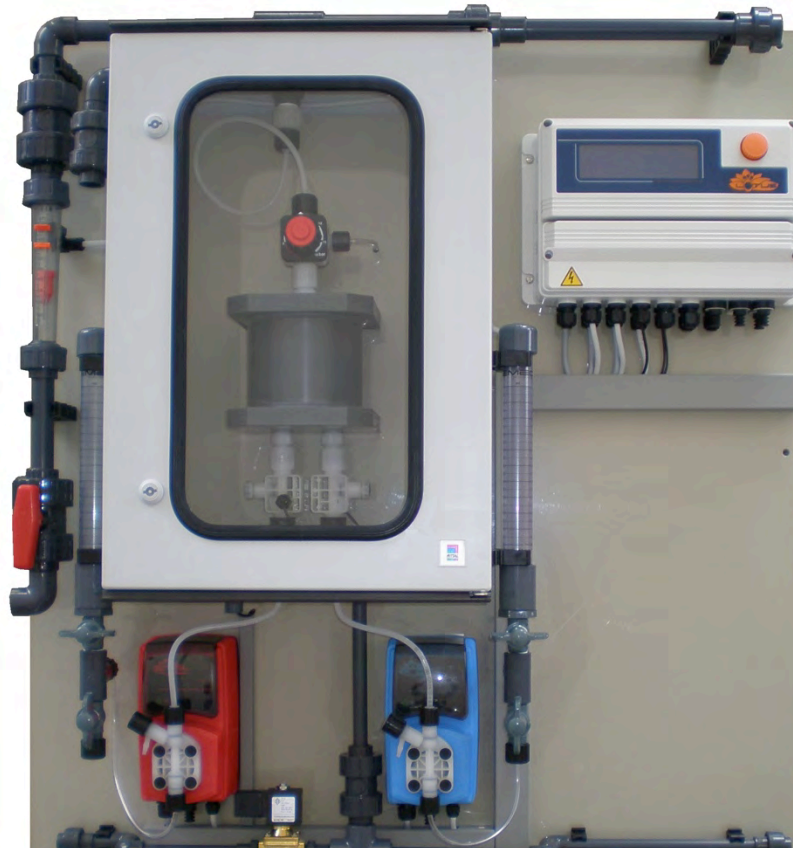

DOWNLOAD ERMES COMMUNICATION SOFTWARE
www.ermes-server.com

Installation and Operation Manual

For authorized service technicians only!



**Read this manual completely before you start with the installation and start-up.
Do not discard this manual and store it nearby the generator for later use.**

This manual contains important information about the installation and operation safety.
Take care about the following instructions to avoid personal injuries and material damages!
The operator is responsible in case of damages caused by installation and operation failures!



READ CHAPTER 5 "STARTUP" FOR FIRST START

English

R12-05-23



NORME CE
EC RULES(STANDARD EC)
NORMAS DE LA CE

Direttiva Bassa Tensione }
Low Voltage Directive } **2014/35/UE**
Directiva de baja tensión }

Direttiva EMC Compatibilit  Elettromagnetica }
EMC electromagnetic compatibility directive } **2014/30/UE**
EMC directiva de compatibilidad electromagn tica }



GENERAL SAFETY GUIDELINES

Danger!

In emergencies the instrument should be switched off immediately! Disconnect the power cable from the power supply!

When installing always observe local regulations!

Manufacturer is not liable for any unauthorized use or misuse of this product that may cause injury, damage to persons and / or materials.

Caution!

Instrument must be accessible at all times for both operating and servicing. Access must not be obstructed in any way!

Feeder should be interlocked with a no-flow protection device to automatically shut-off the pumps when there is no flow!

Pumps and accessories must be serviced and repaired by qualified and authorized personnel only!

Always discharge the liquid end before servicing the instrument!

Empty and rinse the liquid end before work on a pump which has been used with hazardous or unknown chemicals!

Always read chemical safety datasheet!

Always wear protective clothing when handling hazardous or unknown chemicals!

Instrument must be operated / serviced by trained technicians only!

All connection operations must be performed while the instrument is not connected to main supply!

Directory

1.	General Safety Guidelines	4
1.1	Symbols	
1.2	Safety instructions	
1.3	CE-Conformity	
2.	Storage and Transport	9
3.	Construction	10
3.1	Construction overview	
3.2	Description and details	
4.	Installation	13
4.1	General requirements for the installation location	
4.2	Requirements to the water	
4.3	Assembly	
4.4	Hydraulic installation	
4.4.1	Installation to a pressure system	
4.4.2	Installation to a batch tank	
4.5	Electric Installation	
4.5.1	Power supply	
4.5.2	Types of Control	
5.	First Startup	29
5.1	Preparations	
5.2	Hydraulic start-up	
6.	„LOTUS“ - Controller	31
6.1	Start display	
6.2	Main display	
6.3	Control element „Click-Wheel“	
6.4	Status display	
6.5	Logbook	
7.	Configuration Menu	35
7.1	Pumps – Calibration of the dosing pumps	
7.2	Sensors (Probes) – Calibration of the chlorine dioxide probe and temperature sensor	
7.3	(Contact) Water meter	
7.4	Analog outputs	
7.5	Operation mode	
7.5.1	Proportional mode	
7.5.2	Constant mode	
7.5.4	Batch mode	
7.5.5	Proportional & Measuring mode	
7.6	System settings	
9.	LOTUS Terminal board	46
	Configuration Menu Summary & extra functions (bypass alarm, probe flow alarm, mA input)	
10.	Failure Messages	50
APP	Communication	51

1. General Safety Guidelines

1.1 General remarks

This manual includes basic directions for the assembling, operation and maintenance. Therefore it is obligatory for the assembly technician as well as for the operator to study the complete manual before starting with the installation and start-up.

- This manual must be present at the generator at any time.
- It is also obligatory for the operator to consider the general directions in chapter “Safety instructions” as well as the specific safety instructions included in the other chapters of this manual.



Notice:

- For some of the following described functions additional accessories (not included in the delivery scope of LOTUS) may be required.
- Depending to the software release of the LOTUS-controller some of the described features may not be available. Or some functions are available, but not described in this manual. Please contact your dealer in case of the requirement for more information.

1.2 Symbols in the manual

In accordance to the guideline DIN 4844-W9 about the characterization of special risks all safety instructions in this manual are labeled with the following symbols:



Warning:

This symbol is warning about risks.
Disregarding may cause heavy personal injuries, death and material damages.



Caution!

This symbol is warning about troubles caused by incorrect operation.



Notice or advice:

This symbol shows important additional information.

1.3 Symbols at the installation site

In accordance to the guideline DIN 4844-W9 and DIN 4844-2 about the characterization of special risks and prohibitory signs, different areas of the installation site have to be labeled with the following symbols:



Warning:

Corrosive substances – label is located at the LOTUS plant



Danger!

Toxic substances – label must be located at the entrance,
outside of the installation room



Prohibition!

No Fire, naked light – label must be located at the entrance,
and smoking outside of the installation room

1.4 Safety chapter

The three basic rules:



1. The two components acid (diluted HCl) and chlorite (diluted NaClO₂) must never be brought into contact except in the reactor!
Otherwise poisonous ClO₂ gas forms abruptly and can then decompose explosively!
2. Never operate the chlorine dioxide generator LOTUS with undiluted acid or undiluted sodium chlorite!
Otherwise poisonous ClO₂ gas forms abruptly and then decomposes explosively within the reactor!
3. The bypass water must never be exposed to a vacuum pressure!
Otherwise the ClO₂ solution in the reactor is placed under a vacuum, the ClO₂ is degassing, forms a richer mixture and can decompose explosively!

Correct and proper use:



- The LOTUS system is intended solely for producing a ClO₂ containing disinfectant solution from diluted hydrochloric acid (9 %) and sodium chlorite solution (7.5 %) and for dosing it into a bypass line together with water.
- The LOTUS system is not designed for treating liquids (other than water) or gaseous media as well as substances with ClO₂!
- Any other uses or modifications to the system are prohibited!
- The system must not be operated under conditions other than those described in the technical data!
- The un-appropriate use affects the safety function of this generator and other connected devices and is therefore strictly forbidden.
- Do not allow untrained personnel to operate the LOTUS D system! All other activities should only be carried out by trained and authorized personnel, see the following table!
- Assembling and maintenance has to be done by authorized technicians only.
- Maintenance repairs have to be executed only by the manufacturer or authorized technicians. Interventions or changes at the device in opposite to the regular maintenance in accordance to this manual are incorrect and make the all warranty claims nugatory.
- The operator is liable for the observance of the local safety instructions.
- For the operation and service the device must be accessible at all times.
- You are obliged to observe the information contained in the operating instructions at the different phases of the system's service life!
- Please observe the relevant national regulations and guidelines at every phase of the system's service life!
- Take attention to the chemical safety data sheets!
- Wear protection clothes for the handling with hazardous chemicals.

Qualification of personnel:



Warning!

According to accident statistics, holiday replacements are a safety risk. Holiday replacements must also hold the below named qualifications and have been instructed accordingly.

Activity	Qualification level
Installation, installation of hydraulic system	Technical personnel
Electrical installation	Electrician
Initial commissioning	Customer service - authorized by EMEC
Start up	Technical experts
Operation, canister replacement	Instructed personnel
Maintenance, repair	Customer service - authorized by EMEC
Decommissioning, disposal	Technical experts
Troubleshooting	Customer service - authorized by EMEC , technical experts, instructed personnel (fault-dependent)

Technical expert:

A technical expert is deemed to be a person who is able to assess the tasks assigned to him and recognize possible hazards based on his/her technical training and experience, as well as knowledge of applicable regulations.

Qualified personnel:

A qualified employee is deemed to be a person who is able to assess the tasks assigned to him and recognize possible hazards based on his/her technical training, knowledge and experience, as well as knowledge of pertinent regulations.

Instructed personnel:

An instructed person is deemed to be a person who has been instructed and, if required, trained in the tasks assigned to him/her and possible dangers that could result from improper behaviour, as well as having been instructed in the required protective equipment and protective measures.

Customer service department:

Customer service refers to service technicians who have received certificated training and have been authorized by EMEC to work on the system.

Personal protective equipment

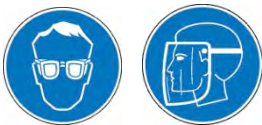

Wear eye protection (minimum outfit)
Wear face shield



Wear protective gloves (ClO₂-resistant type!)



Wear protective apron



Wear rubber or plastic boots

Safety information:



Warning!

Danger from incorrect operation

Incorrect operation can result in dangerous conditions for the system and its surroundings.

- The operating personnel must be instructed by an EMEC service technician. (undertaken during initial commissioning.)
- The operating instructions must be available by the system.



Warning!

Danger due to toxic and explosive ClO₂ gas

Under rare fault conditions ClO₂ solution can escape via a leak.

The installation of a gas detector is recommended to overcome this problem. The detector can switch off the system and create an alarm that is readily apparent from a distance. This ensures a safety operation with every ClO₂ system.

Instructions for entering a room where a chlorine dioxide system is installed

- Access only for trained personnel.
- If there is a smell of chlorine dioxide (pungent, chlorine-like smell) access is only permitted to personnel wearing the specified protective equipment.
- If there is a smell of chlorine dioxide, immediately switch off the system from a safe position, e.g. emergency stop switch, which is installed in a safe distance from the system.

Notes for the system operator in case of an emergency

- **You got into contact with acid:**
See the "EC acid safety data sheet" provided by the supplier!
- **You got into contact with chlorite:**
See the "EC chlorite safety data sheet" provided by the supplier!
- **You got into contact with ClO₂ solution or ClO₂ gas:**
See "Chlorine dioxide hazardous substance data sheet: Properties of chlorine dioxide and instructions for handling aqueous solutions" in this operating instructions, appendix!
- **An orange-yellow ClO₂ gas has escaped:**
Exit the operation room immediately and disconnect the power supply, (use the emergency stop switch)!
Wear complete personal protective equipment.
Take care that the gas is precipitated out of the atmosphere by using a water spray!
See also the data sheet "Chlorine dioxide hazardous substance data sheet: Properties of chlorine dioxide and instructions for handling aqueous solutions" in this operating instructions, appendix!
- **An orange-yellow ClO₂ solution has escaped:**
Exit the operation room immediately and disconnect the power supply, (use the emergency stop switch)!
Wear complete personal protective equipment.
Sprinkle pure sodium thiosulfate solution over the ClO₂ solution. Then dilute with lots of water and flush it away into the drain.
See also the data sheet "Chlorine dioxide hazardous substance data sheet: Properties of chlorine dioxide and instructions for handling aqueous solutions" in this operating instructions, appendix!
- **The LOTUS system was supplied with concentrated chemicals and the dosing pumps have pumped it already to the reactor inlet:**
Exit the operation room immediately and disconnect the power supply, (use the emergency stop switch)!
Contact immediately the fire and rescue service and explain them about the risk of an explosion due to concentrated ClO₂ gas!

ClO₂ gas can still explode after several hours!
See also the data sheet "Chlorine dioxide hazardous substance data sheet: Properties of chlorine dioxide and instructions for handling aqueous solutions" in this operating instructions, appendix!

- **The LOTUS system was supplied with concentrated chemicals but the dosing pumps have not yet started:**

Immediately switch the LOTUS system to „OFF“ or “Stand-by”!
Place the suction lances of both chemicals into separate buckets with water.
Arrange for the concentrated chemicals to be properly disposed off.
See also the data sheet "Chlorine dioxide hazardous substance data sheet: Properties of chlorine dioxide and instructions for handling aqueous solutions" in this operating instructions, appendix!



Directions for the operator

(Specific information for applicable regulations in Germany):

- Accident prevention regulation (UVV) „Chlorination of water“, GUV V-D5 E.
- „Dosing plants for chlorine dioxide“, DVGW [German Gas and Water Association] guideline W 624 (latest version respectively).
- „Chlorine dioxide in water treatment“, DVGW worksheet W 224 (latest version respectively).
- Directive for the protection of groundwater against pollution. (§ 19 Federal Water Act – WHG dated 23/09/1986).
- German Ordinance of hazardous substances (GefStoffV) – especially § 17 (obligatory protection) and § 20 (operation instruction).

1.5 EU Declaration of Conformity



The LOTUS generator is corresponding to the following EU-standards:

The following standards are considered:

- EU Machinery Directive (2006/42/EC)
- EU EMC Directive (2004/108/EC)
- Low-voltage directive 2006/95/EC according to Appendix I, No. 1.5.1 of the Machinery Directive 2006/42/EC
- EU Pressure Equipment Directive (97/23/EC)

The following harmonized standards are considered:

- EN ISO 12100-1, EN ISO 12100-2, EN 809
- EN 60206, EN 60529, EN 61000-6-1/2/3/4

The following harmonized national standards are considered:

- DVGW standards: Technical rules W 224 and W 624



Notice:

A declaration of conformity can be ordered from the manufacturer.

2. Storage and Transport

Safety information:



Warning!

- Return the device for repair only in a cleaned condition with emptied hydraulic components - refer to the chapter "Decommissioning"!
- Send the unit back together with a complete filled decontamination declaration form. The decontamination declaration is a decisive part of an inspection / repair order. A unit can only be inspected or repaired when a decontamination declaration form is submitted that has been correctly completed by an authorized and qualified person on the behalf of the operator.

The "Decontamination Declaration Form" can be requested / print in the appendix or under www.emec.it



Notice:

Danger of material damage

The device can be damaged by incorrect or improper storage or transportation!

- The device should only be stored or transported in a well packaged condition - preferably in its original packaging.
- The packaged unit should also only be stored or transported in accordance with the stipulated storage conditions.
- The packaged unit should be protected from moisture and the ingress of chemicals.

Packaging:

The LOTUS chlorine dioxide system is supplied in a heavy cardboard box – wrapped with foam – on a palette

Ambient conditions:

Data	Value
Minimum storage and transport temperature	-10 °C
Maximum storage and transport temperature	+40 °C
Maximum air humidity (not condensing)	90° rel. humidity

Il biossido di cloro, come tutti gli agenti ossidanti, potrebbe produrre fenomeni di corrosione dell'impianto. Si consiglia di effettuare verifiche cadenzate e di trattare l'impianto con prodotti chimici specifici. Si consiglia, inoltre, di utilizzare nel punto d'iniezione del prodotto materiali resistenti al biossido di cloro.

Chlorine dioxide, like all oxidizing agents, could produce corrosion phenomena of the plant. It is advisable to perform cadenced checks and to treat the plant with specific chemical products. It is also advisable to use chlorine dioxide resistant materials at the point of injection of the product.

Le dioxyde de chlore, comme tous les agents oxydants, pourrait produire des phénomènes de corrosion de l'installation hydraulique. Il est conseillé d'effectuer des contrôles cadencés et de traiter l'installation avec des produits chimiques spécifiques. Il est également conseillé d'utiliser des matériaux résistants au dioxyde de chlore au point d'injection du produit.

3. Construction

3.1 General description

The chlorine dioxide generator is used for the production of liquid chlorine dioxide. This disinfection agent kills all bacteria, germs, viruses and fungi within shortest time – and it works with very low concentration.

The generator is working with the hydrochloric acid – chlorite process and uses the diluted chemicals hydrochloric acid (HCl 9%) and sodium chlorite (NaClO₂ 7.5%) in accordance to the following chemical equation:

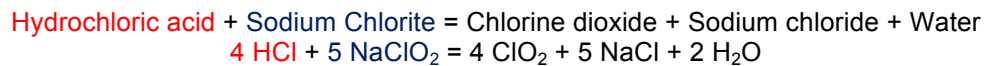

In the process each chemical is pumped with a specific proportion into a reactor vessel [23] by two dosing pumps [5 and 6]. Each stroke from each pump is triggered by the LOTUS-controller [8] and counter-controlled by a “SEFL” [25 and 28].

Inside the reactor vessel the chemicals are reacting to chlorine dioxide with a concentration of 2% (= 20 g/l).

The finished chlorine dioxide leaves the reactor vessel through a back pressure valve [21] on the top of the reactor and an injection valve [20] into a bypass line for an advanced dilution with water.

The advantages are:

- The chlorine dioxide can be pumped direct into pressurized systems with the pressure of the pumps and likewise into pressure-less storing tanks, to distribute the disinfection liquid to different points of use.
- The System can work in proportional mode with contact water meter, current signal or chlorine dioxide measurement.

WARNING: follow European directive DIN EU 939 concerning HYDROCHLORIC ACID
follow European directive DIN EU 938 concerning SODIUM CHLORITE

3.2 System overview

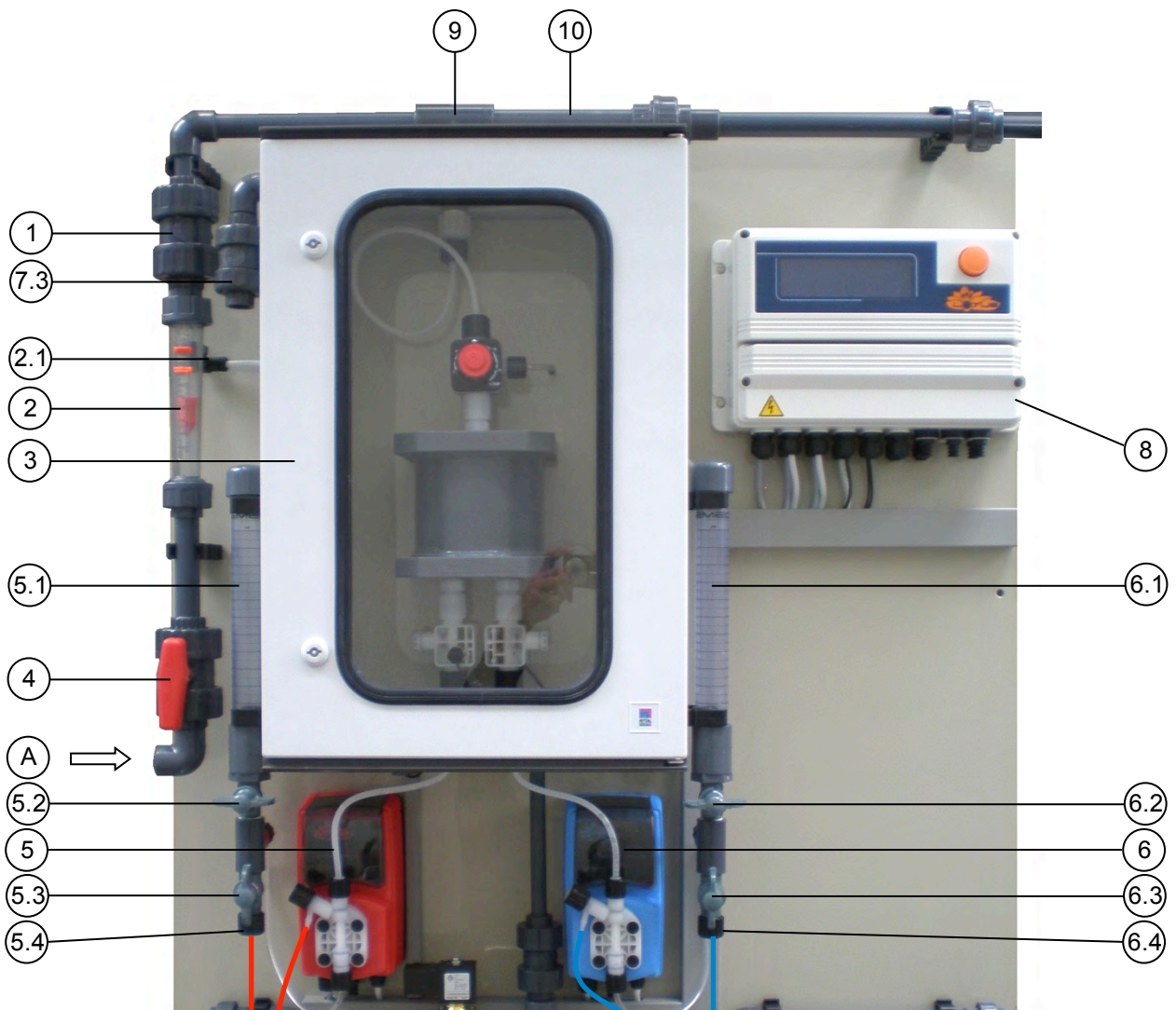
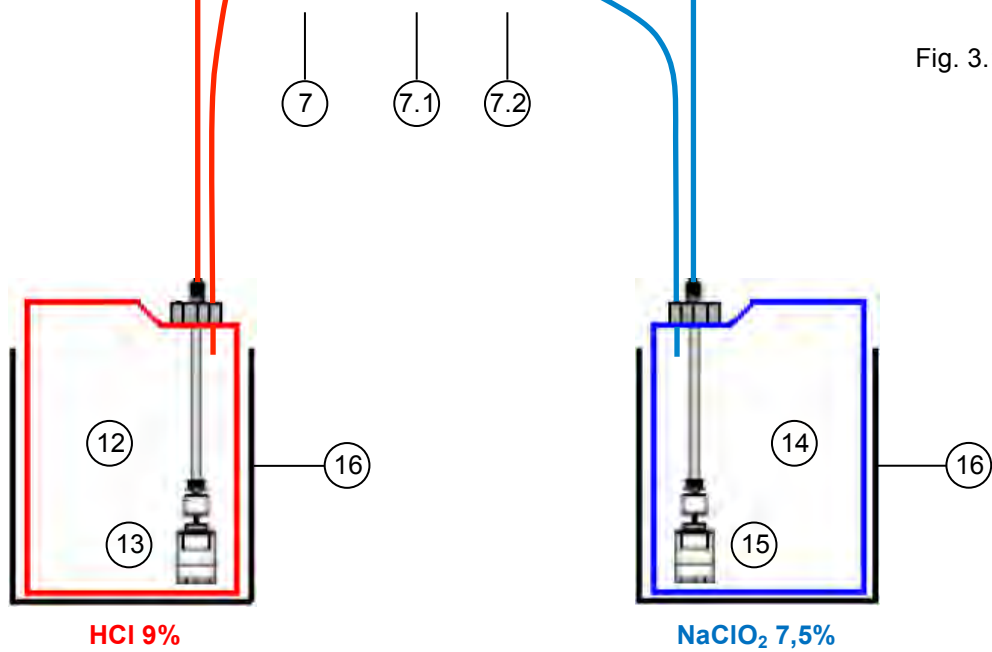

Fig. 3.1



- | | | | |
|-----|-----------------------------------|-----|---|
| 1 | Check valve | 7.1 | Solenoid valve |
| 2 | Flow meter with floater | 7.2 | Water-jet pump |
| 2.1 | Switching contact | 7.3 | Reactor housing venting valve |
| 3 | Reactor housing | 8 | LOTUS controller |
| 4 | Ball valve | 9 | Reactor outlet valve |
| 5 | Acid dosing pump | 10 | Static mixer |
| 5.1 | Calibration cylinder | | |
| 5.2 | Ball valve | | |
| 5.3 | Ball valve | | |
| 5.4 | Hose connection for suction lance | | |
| 6 | Chlorite dosing pump | | |
| 6.1 | Calibration cylinder | 12 | Tank with hydrochloric acid 9 % |
| 6.2 | Ball valve | 13 | Suction lance with level-switch „Hydrochloric acid“ |
| 6.3 | Ball valve | 14 | Tank with sodium chlorite 7.5 % |
| 6.4 | Hose connection for suction lance | 11 | Level switch „Dilution water tank empty“ |
| | | 15 | Suction lance with level-switch „Sodium chlorite“ |
| | | 16 | Safety tub (Option) |

- A Pipe connection for bypass line DN 20, PVC socket 25 mm
 C Drain

3.3 Reactor overview

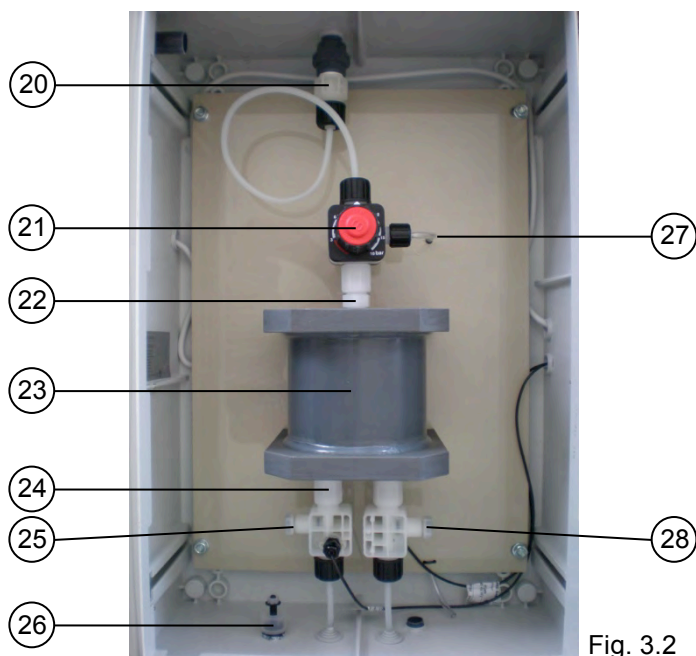

Fig. 3.2

- | | | | |
|----|----------------------------|----|------------------------------|
| 20 | Injection valve | 25 | SEFL Acid dosing control |
| 21 | MFKT Multi function valve | 26 | Level switch "Leackage" |
| 22 | Check valve 0.3 bar | 27 | Over-pressure drain tube |
| 23 | Reactor | 28 | SEFL Chlorite dosing control |
| 24 | Check valve 5 bar (qty. 2) | | |

4. Installation

Safety information:



Warning!

- For the operation of the LOTUS generator the absolute observance of the national and local regulations is required. The operator is liable for the observance of the local safety instructions.
- The generator must be installed and started up in accordance to the regulations in this manual.
- The usage of installation parts not approved by the manufacturer or supplier is prohibited.
- The operation of the generator is allowed only with suitable safety-valves approved by the manufacturer. The contempt of this regulation results the ultimate loss of any warranty claims!
- Before starting works at the plant decompress all parts of the system.
- The plant never has to work against closed valves because of the risk of bursting hoses or pipes.
- Disconnect the power supply before opening the controller housing.
- Take care of all national regulations during installation!

4.1 General requirements for the installation site



Notice:

- The plant must not be placed outdoors.
- The plant must be protected against unauthorized access.
- The site must be protected against sunlight and frost and well ventilated.
- For temperatures less than 10° C a suitable tempering system for the site is required.
- It must be possible to transport the chemical containers to the plant without any obstructions.
- An emergency exit route is stringent required!
- The plant must be mounted onto a vertical solid wall without tensions.
- The plant must be mounted in a way that no vibrations can be produced.
- Take care of free entrance from all sides for the operation and maintenance!
- Tap water and a lockable floor gully should be present for the risk-free removal of spilled chemicals.
- A fuse-protected power-supply with an emergency stop-switch outside the installation room is required.

4.2 General requirements for the plant installation



Notice:

- The LCD screen of the control can be easily read.
- The liquid level of the full chemical containers is below the dosing pumps.
- The maximum priming lift of the dosing pumps is not exceeded, see table "Technical data" in the appendix.
- As necessary, there is still sufficient space for the chemical containers below the panel.

4.3 Requirements for the water

Safety information:



Warning!

Serious malfunctions at the plant or corrosion damages in the pipe-work of the treated water should be possible in case the following requirements to the water – the chlorine dioxide is produced for – as well as for the dilution water are not fulfilled:

Temperature: 10 – 30° C

Pressure: 0.3 - 8 bar

Quality: Free of iron, manganese and particles, non-corrosive.

The following directions are based on a concentration for chlorine dioxide of 0.4 mg/l to prevent pipe-corrosion:

- The pH-level should be always higher than pH 6.5.
It should be controlled during operation.
- In case the carbonate hardness is lower 1.1° dH (German hardness) or the alkalinity is lower 0.4 mMol/l the dosing of suitable chemicals for the increase of the pH-level is required.

4.4 Assembling

- The plant must be mounted onto a vertical solid wall without tensions.
- The plant must be mounted in a way that no vibrations can be produced.
- The location should be nearby the chlorine dioxide injection point.
- Take care of free entrance from all sides for the operation and maintenance!
- The plant-bottom should be minimum 1 m over the floor-level.
- The level of the complete filled chemical tanks must always be under the level of the dosing pumps.
- The maximum suction-height for the dosing pumps should be not more than 2 meters.
- Fix the plant with the six mounting-holes of the panel to the wall.



Notice:

For a safety fastening hanger bolts M8 x 60 mm are suggested.

4.5 Hydraulic Installation

Safety information:



Warning!

Warning against illegal operation

Observe the regulations about the plant location.



Danger!

Warning of toxic chlorine dioxide vapour

Toxic chlorine dioxide vapour can escape because of a broken bypass line.

- Use only PVC or PVDF pipes for the bypass line.
- Use only PVC pipes of pressure rating PN 16 for the bypass line.
- The maximum permissible system operating pressure must not be exceeded – see "Safety equipment bypass line" – "PVC bypass line specifications").
- Pressure surges must be avoided.



Warning!

The reactor can explode

In case of an uncontrolled sucking of the chemicals into the reactor, caused by a vacuum in the bypass-line and a simultaneous formation of gas/water mixed phases, chlorine dioxide can gas out. Under adverse circumstances, the critical gas concentration of 300 g/m³ is exceeded and an explosion of the reactor can occur.

Take appropriate measures to ensure that the bypass line of the LOTUS system does not become subject to a vacuum.

Main components:

Basically the following hydraulic components must be installed:

- Bypass line
- Safety equipment of bypass line (optional)
- Additional safety fittings (optional)
- Point of injection (optional)
- Hydraulic module "water supply" (optional)
- Flushing equipment with vacuum relief valve (optional)
- Suction lances / suction assemblies acid and chlorite
- Water supply suction mechanism (optional)

4.5.1 Installation example A

- Point of injection (34) direct in the main water supply.
- Operation mode: "Proportional"

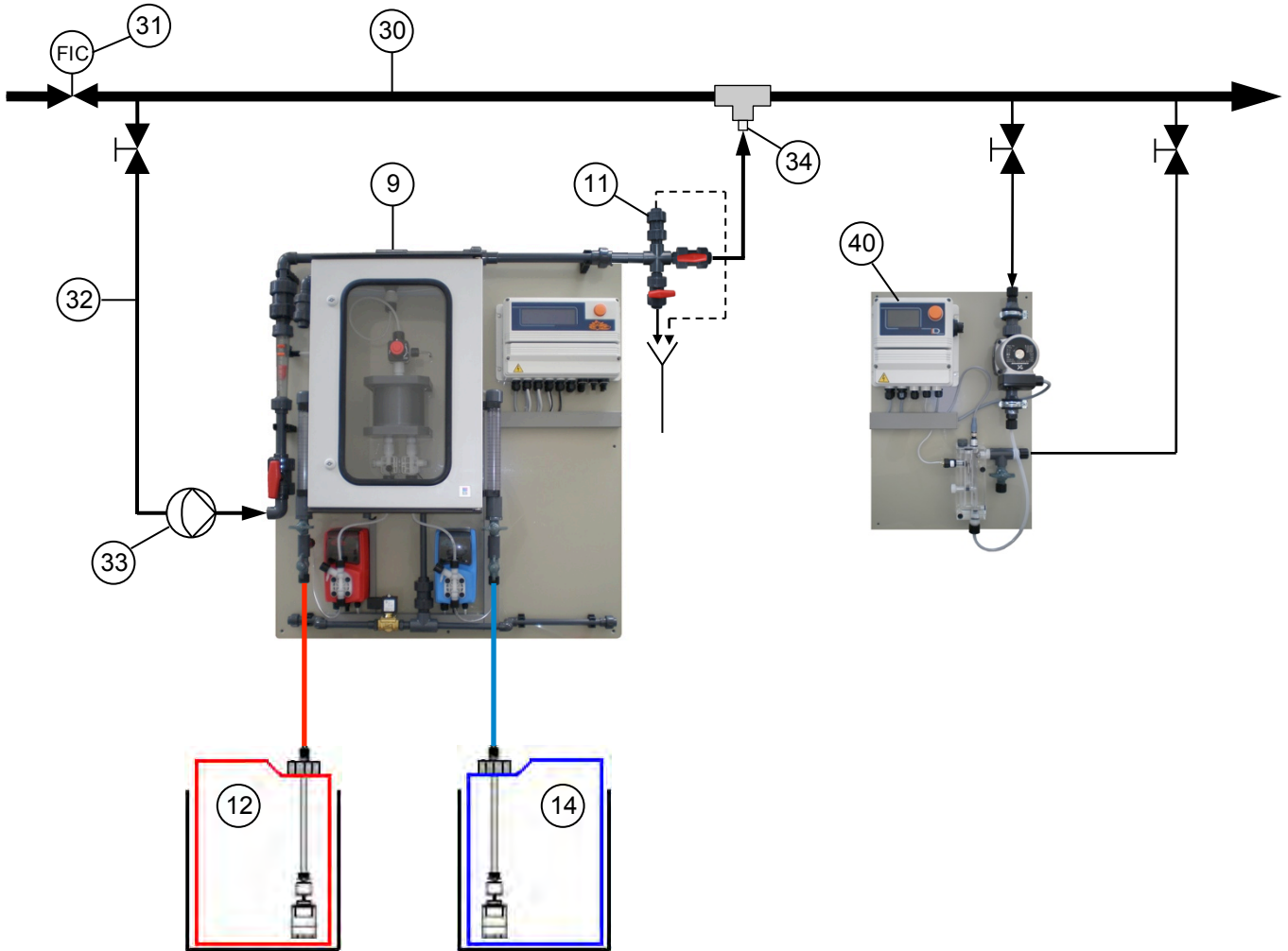

Fig. 4.1

- | | | | |
|----|---|----|---|
| 9 | Reactor outlet valve | 30 | Main water supply |
| 11 | Flushing unit with vacuum relieve valve | 31 | Water meter (frequency or analog signal) |
| 12 | Acid tank in safety tub | 32 | Bypass line |
| 14 | Chlorite tank in safety tub | 33 | Bypass pump |
| | | 34 | Point of Injection (immersion pipe) |
| | | 40 | ClO ₂ – Measuring unit type PA-LDCLO2+CP |

4.5.2 Installation example B

- The reactor outlet valve (9) of the LOTUS system is located beneath the point of injection (34).
- Operation mode: "Proportional"

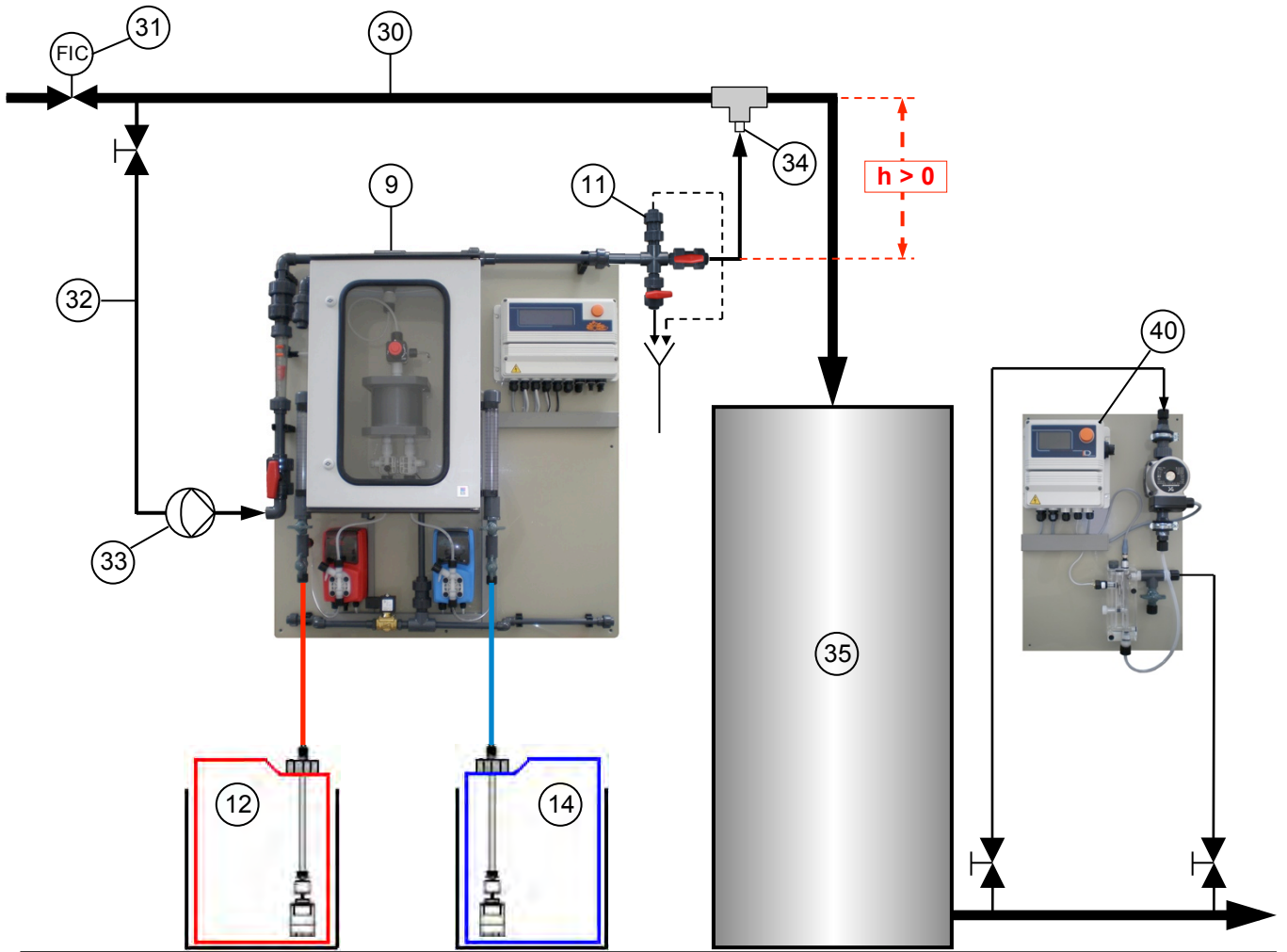
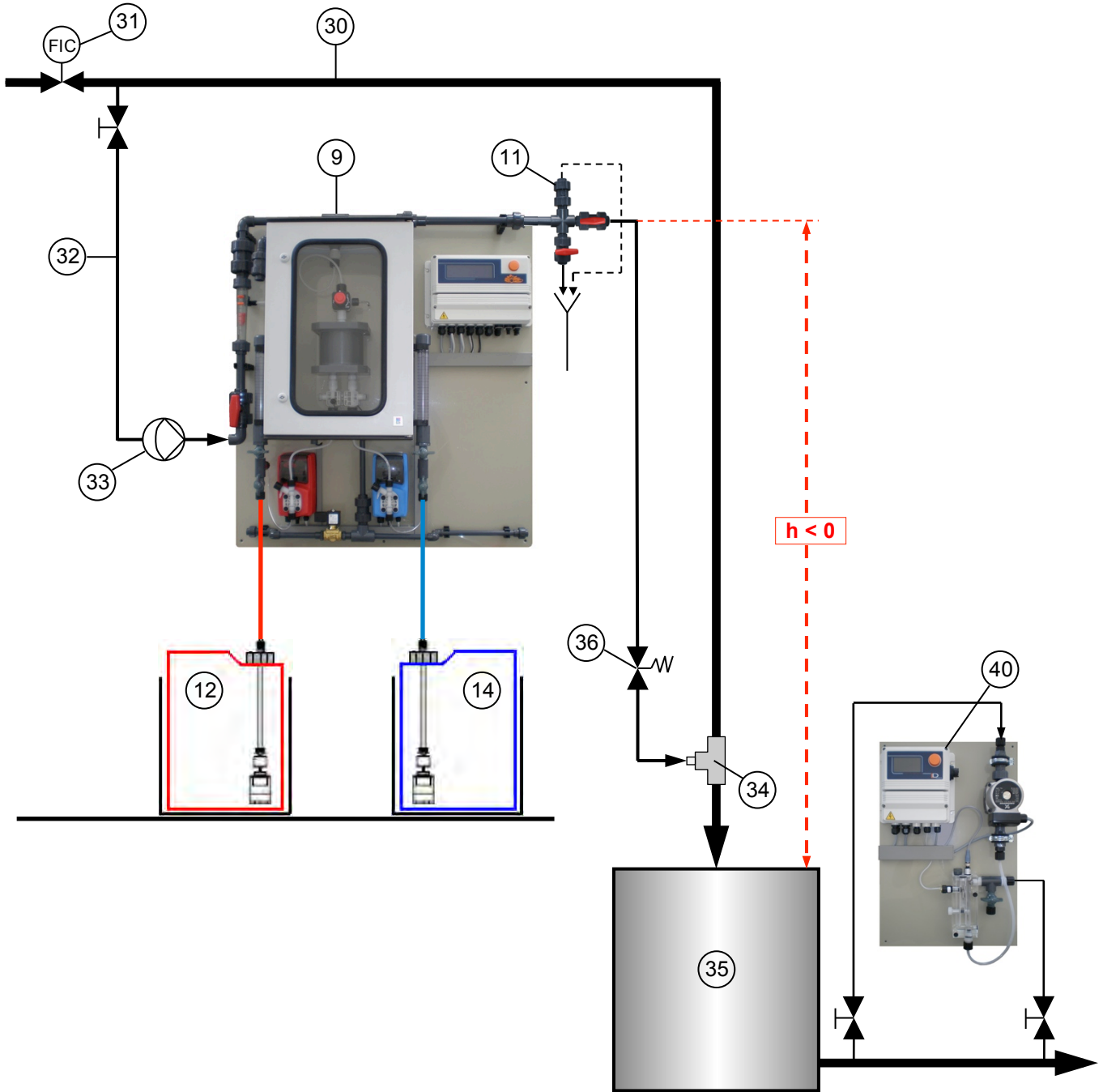

Fig. 4.2

- | | | | |
|----|---|----|--|
| 9 | Reactor outlet valve | 30 | Main water supply |
| 11 | Flushing unit with vacuum relieve valve | 31 | Water meter (frequency or analog signal) |
| 12 | Acid tank in safety tub | 32 | Bypass line |
| 14 | Chlorite tank in safety tub | 33 | Bypass pump |
| | | 34 | Point of Injection (immersion pipe) |
| | | 35 | Delay tank |
| | | 40 | ClO ₂ – Measuring unit type PA-LDCLO ₂ +CP |

4.5.3 Installation example C

- The reactor outlet valve (9) of the LOTUS system is located beneath the point of injection (34).
- Operation mode: "Proportional"



- | | | | |
|----|---|----|---|
| 9 | Reactor outlet valve | 30 | Main water supply |
| 11 | Flushing unit with vacuum relieve valve | 31 | Water meter (frequency or analog signal) |
| 12 | Acid tank in safety tub | 32 | Bypass line |
| 14 | Chlorite tank in safety tub | 33 | Bypass pump |
| | | 34 | Point of Injection (immersion pipe) |
| | | 35 | Delay tank |
| | | 36 | Back pressure valve |
| | | 40 | ClO ₂ – Measuring unit type PA-LDCLO2+CP |

Fig. 4.3

4.5.4 Installation example D

- Batch tank filling with water supply module
- Operation mode: "Batch"

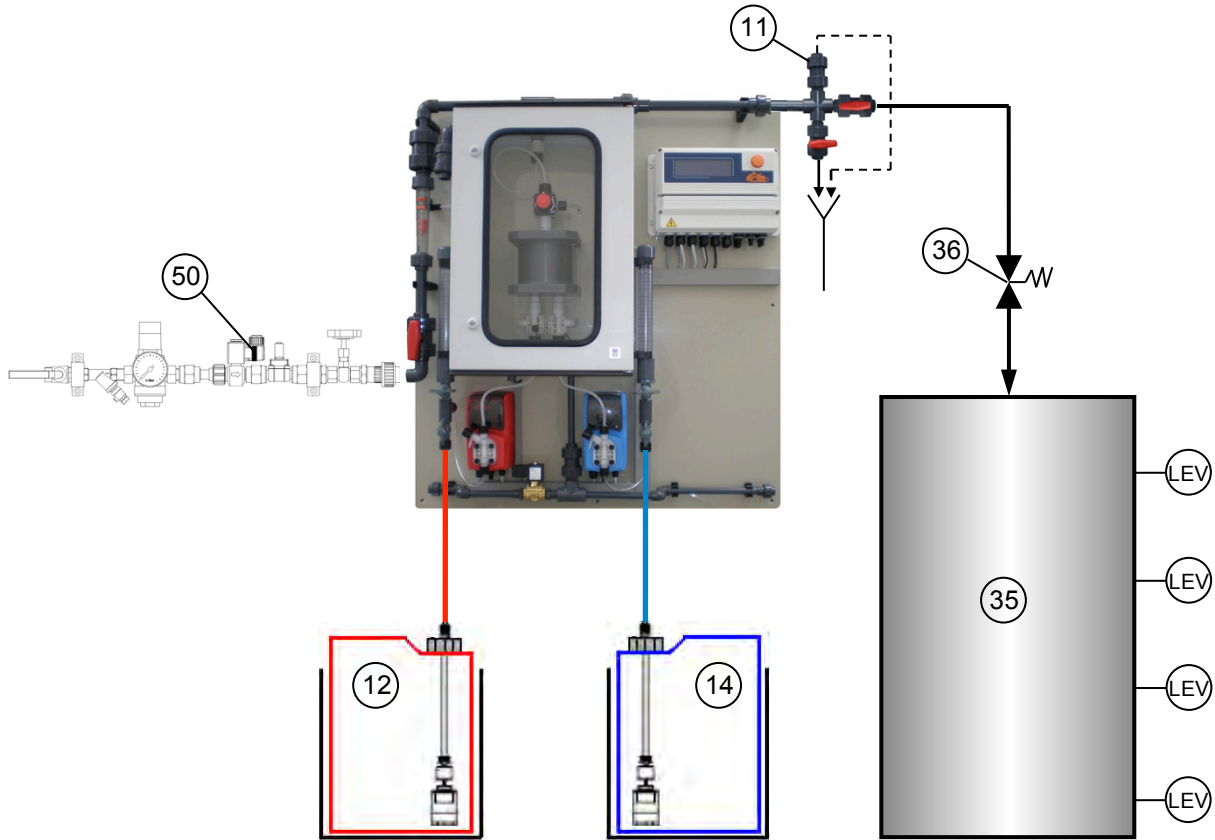

Fig. 4.4

- | | | | |
|----|---|----|-----------------------|
| 11 | Flushing unit with vacuum relieve valve | 35 | Batch or storage tank |
| 12 | Acid tank in safety tub | 36 | Back pressure valve |
| 14 | Chlorite tank in safety tub | 50 | Module "Water Supply" |

4.6 Hydraulic Installation of accessories and options

4.6.1 Bypass line

Safety information:



Danger!

Warning of toxic chlorine dioxide vapour

Toxic chlorine dioxide vapour can escape because of a broken or leaking bypass line.

- Use only PVC or PVDF pipes for the bypass line.
- Use only PVC pipes of pressure rating PN 16 for the bypass line.
- The maximum permissible system operating pressure must not be exceeded – see "Safety equipment bypass line" – "PVC bypass line specifications").
- Pressure surges must be avoided.



Warning!

The reactor can explode

- In case of an uncontrolled sucking of the chemicals into the reactor, caused by a vacuum in the bypass-line and a simultaneous formation of gas/water mixed phases, chlorine dioxide can gas out. Under adverse circumstances, the critical gas concentration of 300 g/m^3 is exceeded and an explosion of the reactor can occur.

Take appropriate measures to ensure that the bypass line of the LOTUS system does not become subject to a vacuum.

- Particles in the bypass water could block the flow meter. This can lead to an unacceptably high concentration of chlorine dioxide. If a bypass line is not completely full with water, a critical gas phase can form, resulting in an explosion in the bypass line.
Install a dirt-trap filter in the bypass line, if required.

Function:

The bypass line (32) is either fed from the main water supply (30) or separately. The purpose of the bypass line is to dilute the concentration of the chlorine dioxide solution coming out of the reactor from approximately 20 g/l (= 20,000 ppm) to approximately 0.1 - 1 g/l (= 100 - 1000 ppm) and to transport this solution to the point of injection (34).

4.6.2 Safety equipment bypass line

Safety information:



Warning!

The reactor can explode

If the chlorine dioxide solution in the reactor becomes subject to a vacuum, it can explode.

Hence the bypass line should be installed so that it is impossible for a vacuum to arise, not even when the plant is stand-by or in the case of a fault.

Risk of explosion in the bypass line

If the dosing remains switched on when there is no water flow, it can lead to an unacceptably high concentration of chlorine dioxide in the bypass line. If in addition, the bypass line is not completely full with water, a critical gas phase can occur, resulting in an explosion in the bypass line.

Function:

In systems with bypass monitoring, the LOTUS controller switches the dosing off, when the minimum contact (2.1) at the flow meter (2) is correctly adjusted.

Safety information:



Warning!

Degassing ClO₂ solution can still vaporize in the bypass line.

If the vacuum relief valve (11.2) becomes blocked due to dirt, it cannot prevent degassing of the ClO₂ solution in case of vacuum in the bypass line.

If dirt can enter the vacuum relief valve (11.2) from above, protect it with a suitable cover.



Danger!

Poisonous ClO₂ solution can escape

Protect the rinse valve (11.1) against unintentional opening, e.g. using a cable tie or a padlock.

Function:

The “Flushing unit” with vacuum relieve valve is an option for the easy and fast rinsing of the reactor and the dosing pumps.

For more information about suitable flushing units see chapter “Ordering information”.

4.6.4 Back pressure valve

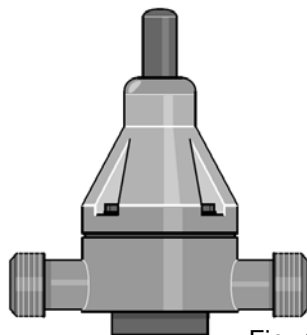

Fig. 4.6

Function:

A back pressure valve (36) placed at the end of the bypass line – with a opening pressure > 1.5 bar – shortly before the point of injection (34). Use the back pressure effect-free design to maintain a operation even at high back pressures!

For more information about suitable bypass pumps see chapter “Ordering information”.

4.6.5 Flow generator for bypass line

Function:

To create a flow in the bypass line, two alternatives are recommended:

- A choke valve in the main water supply line, e.g. gate, spring or weight-loaded non-return valve.
- A bypass water pump (33) in the bypass line prior to the LOTUS system. The bypass pump can be locked via the LOTUS controller. When installing a bypass pump, the installation of a Y-type valve for the flow-adjustment is recommended.

For more information about suitable bypass pumps see chapter “Ordering information”.

4.6.8 Suction lances

Safety information:



Danger!

Warning of toxic chlorine dioxide gas

Toxic chlorine dioxide gas can arise outside the reactor.
Allocate parts correctly to the acid and chlorite sides.



Warning!

Warning of corrosive acid or toxic chlorite solution

Corrosive acid or toxic chlorite can escape at the connections.
Only use suitable hoses and connector kits.

Assembly:

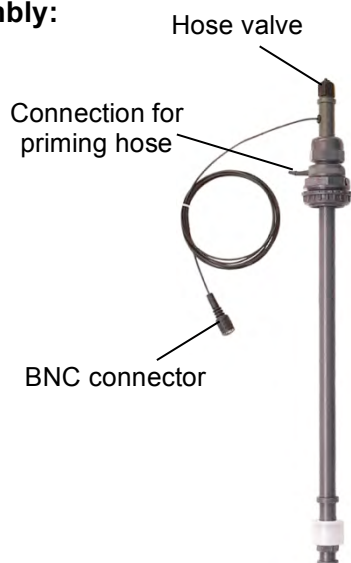

Fig. 4.9

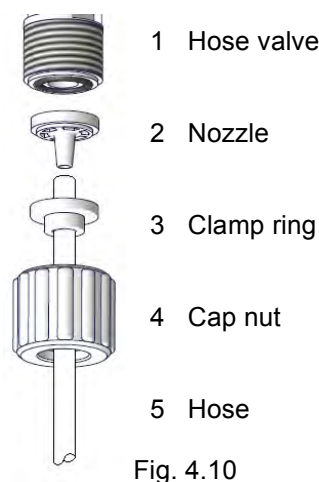

Fig. 4.10



Caution!

The suction hoses must not be plugged into the chemical tanks yet!

First connect the suction hoses to the suction lances:

1. Pull the cap nut (4) and clamp ring (3) over the suction hose (5)
2. Push in the hose end up to the stop over the nozzle (2)
(it may be necessary to slightly widen the hose end).
3. Fit the nozzle on the hose valve of the suction lance (1).
4. Slip the clamp ring (3) onto the nozzle (2) and tighten the cap nut (4).
5. Adjust the length of each suction lance - the foot valve must subsequently float in the container just above the floor.
6. Shorten the suction hoses so that they rise continuously and free from tension.
7. Repeat step 1 – 4 to fit the free ends of the suction hoses to the hose connections (5.4 and 6.4 in Fig 3.1).
8. Connect the priming valves of the dosing pumps to the priming hose nipple of the suction lances with a PVC hose (included in the scope of delivery).
9. At least connect the BNC connectors for the suction lance level-switch to the suitable connection socket at the LOTUS controller.



Caution!

The suction lances have colored screw-caps: Red for acid and blue for chlorite.
Don't alternate the connections!

4.7 Electrical Installation



Caution!

- Installation only made from an authorized expert!
- In Germany: Take the instructions of VDE 0165 into consideration. In foreign countries: Consider the current national regulations!
- Risk of electric shock!
- Take care that the power supply meets the power requirements of LOTUS (see plant-label).
- Disconnect power supply before opening the controller housing!

Basically the electrical installation involves the following work:

- Installation of the main power supply
- Installation of the emergency stop switch at the room entrance
- Connection of a water meter
- Connection of the level switches from the suction lances
- Connection of a bypass pump
- Connection of a gas detector (if required)

4.7.1 Power supply

LOTUS has a standard cable with CE-connector. For the power supply a fail-saved humid room damp proved electric socket is required.



Caution!

- The electric socket has to be placed nearby LOTUS for easy disconnection in case of emergency stop or maintenance.
- The electric socket must be placed free for easy access from all sides.
- A suitable overload protection for the power supply is stringent required!

4.7.2 Installation of an emergency stop switch



Warning!

After particular incorrect operations or faults, it can be dangerous to approach to the system. Then you must at least switch the system off using an emergency stop switch, which is located at a safe distance.

- Install an emergency stop switch in the mains supply cable.
- The emergency stop switch must be installed in an easily accessible, invulnerable position in the vicinity of the door of the installation room of the chlorine dioxide system and must be suitable labeled.
- The emergency stop switch must disconnect the electrical supply equipment connected to the system from the mains.

4.7.6 Installation of a gas detector



Notice:

To increase the safety, a chlorine dioxide gas detector is strongly recommended. Connect the device to the LOTUS controller in accordance with the wiring diagram in chapter "LOTUS terminal board"

As soon as the gas detector detects chlorine dioxide, it switches the system off and the LOTUS controller generates an alarm.

For more information about a suitable gas detector see chapter "Ordering information".

4.8 Placing of warning labels

In case there are no other special national regulations or directives, place the following symbols and labels beside the entrance of the plant operation room:



Danger!
Toxic substances

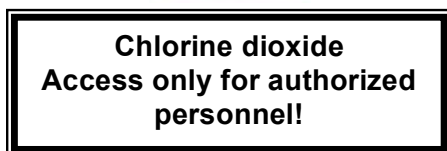

Prohibition!
No Fire, naked light and smoking

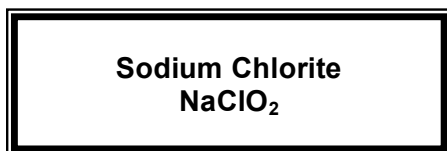

11. NOTES

5. Startup



Warning!

For the first startup it is strongly recommended to use water instead of the chemicals to avoid accidents with hazardous chem.s because of leakages! So in the following explanations the water is called "chemicals".

5.1 Preparations

- Go at first to chapter "6. LOTUS Controller" and study how to handle the different control display and the "Click-Wheel".
- Open the ball valve (4) of the bypass line.
- Open the ball valve (11.3) of the flushing unit to bleed the bypass line.
- Put the suction lances for hydrochloric acid (13) and sodium chlorite (15) into cans filled with clean water.
- Open the ball valves (5.3 and 6.3) of the suction lines for the dosing pumps. Take care that the ball valves of the calibration cylinders (5.2 and 6.2) are closed.

5.2 Hydraulic startup

- Plug the power supply into the socket.
The LOTUS-controller starts with the start-display and changes to the main-display after some seconds.
The bypass-pump starts running too.

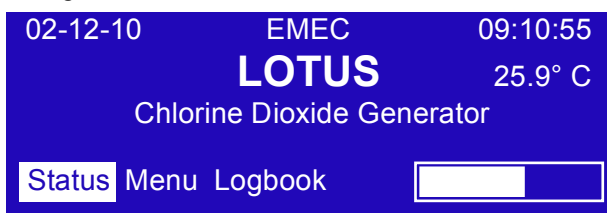

- Use the click-wheel, go to „Status“ and then to „Priming“.
Adjust the bypass flow with the ball-valve (4) together with the flow meter (2) until the floater stands stable at the floater switching contact (2.1). In the "Status" display you can verify with the indicator "Check Water" the proper flow.

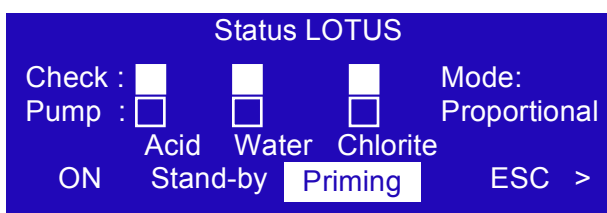

- Push the click-wheel and open the sub-display for the priming mode. Note: priming mode doesn't operate if level or external signal alarm is on.
- Insert a time in field „Input“ (for example 10 minutes) and start the count-down with "Start".
Both dosing pumps start running with max. pulse frequency.

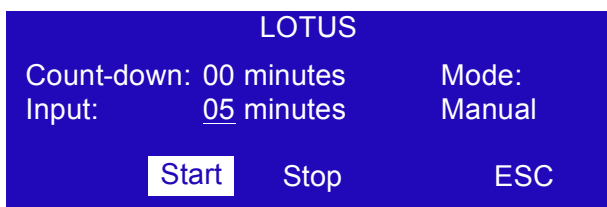

-
- Open the priming valves at the dosing pumps (5 and 6).
The pumps keep on running until the count-down stops or the process is interrupted with the “*Stop*” button.
 - Shut the priming valves as soon as the chemicals flow out without gas-bubbles back into the cans.
When the pumps are still running because the count-down is still activated you can verify in the “*Status*” display with the blinking signals “*Check*” for the dosing control and “*Pumps*” for the dosing pumps that the pumps and suction- and delivery-hoses are proper vented. (You find more information about the functions of the “*Status*” display in chapter 6.4).

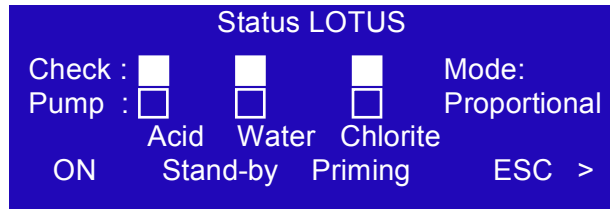

- Let the pumps keep on running to fill-up the reactor completely with water until the count-down stops. In case the reactor is not filled, or the suction and delivery lines of the pumps are not proper vented, go back again into the “*Priming*” display and repeat the process as often as you can see water flowing through the dosing line between the injection valve (20) and the MFKT-valve (21).
- Push the click-wheel on “*ESC*” and leave the priming mode.



Caution!

After a successful priming and filling of the reactor, check the whole system for leakages.

- Start the configuration of LOTUS for the adaption to the local requirements.

6. „LOTUS“ Controller

6.1 Start display

When the power supply is switched on the start display appears and shows the actual software release for some seconds.



After approx. 3 seconds the program goes onto the main display.

6.2 Main display



The main display is separated into 5 lines::

- 1: Date and time
- 2: Measuring value for temperature (in case this option is implemented)
- 3: Type of plant
- 4: Information line for operation, status or failure messages (blinking)
- 5: "Click-Wheel" operation and duty line.

A constant running bar shows that the LOTUS is active.

6.3 Control element „Click-Wheel“

On the right side of the display a turning- and push-button is located. It is called „Click-Wheel“.

You can turn the click-wheel into both directions to scroll through the menus or select a function. The selected function is shown in an inverse color.

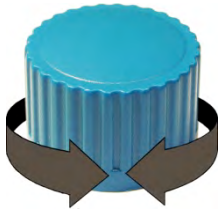

Turn for scroll

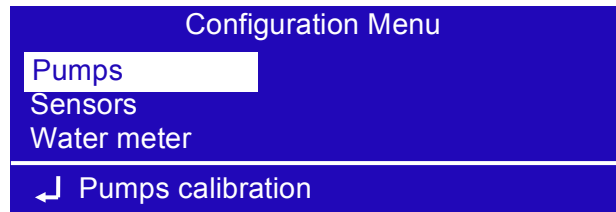

The actual position is shown **Inverse**.



Push for selection



Push the click-wheel for selection.

When you leave a sub-menu with **OK** or **Ex** you will be asked if you want to save the inputs or changes:

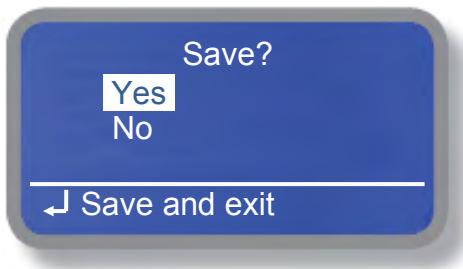

- Select „Yes“ to accept the inputs and changes.
- Select „No“ in case the previous settings should be preserved.

In case you leave a sub-menu with **ESC** and without any changes the previous settings are preserved.

6.4 Status Display

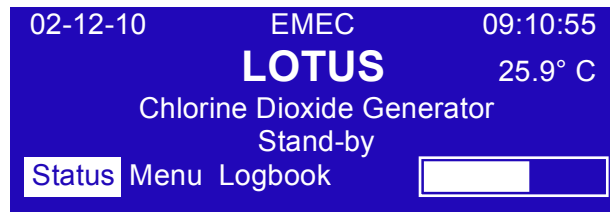

Push the click-wheel on “Status” to open 4 different operation display:

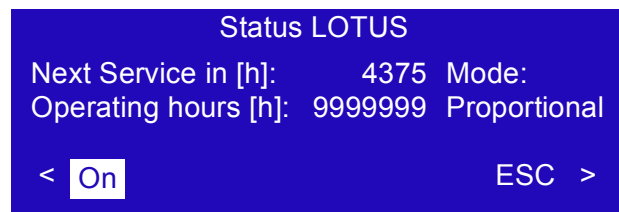
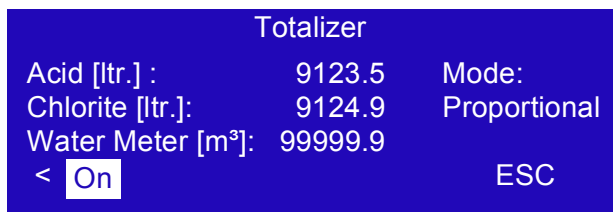
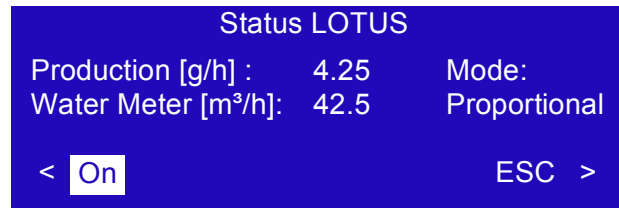
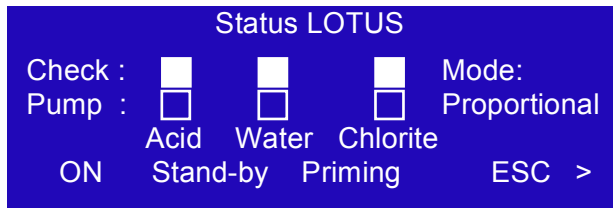

Check: The indicators are showing the function of the dosing controls.

At stagnant production the signal light shows .

During production the signal lights from the dosing controls “Check” are blinking inverse corresponding to the signals from the „Pump“.

That means: in the moment when a pump is doing a stroke (light =), the light of the dosing control has to show .

Check Water: This indicator shows the status of the bypass line. The signal is coming from the switching contact (2.1) at the flow meter (2).

Pump: See also „Check“.

Mode: Shows the activated operation mode.

Production: Shows the actual chlorine dioxide production capacity.

Water Meter: Shows the actual flow capacity of the contact water meter.

Next Service: Shows the remaining time until the next service is required.

Operating hours: Shows the operating hours counter.

In the operation display you have different options:

ON/OFF Start/Stop LOTUS

STAND-BY Switches LOTUS into the “Stand-by” mode, independent to the function of the “Stand-by” – Input

PRIMING Opens the display for dosing pumps priming resp. for manual mode

ESC Go back to the main display

< or > Scroll in the operation display

6.5 Logbook



Turn the click-wheel onto the field "Logbook" and push it to open the sub-menu.

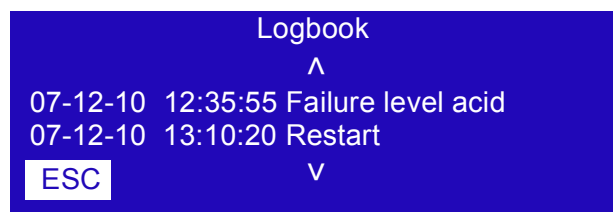
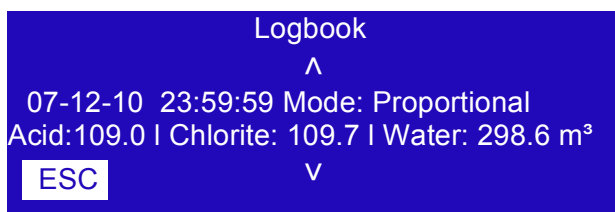

The LOTUS-controller has an internal logbook-memory. Two different types of data are stored together with a time-stamp: Operation data in periodic intervals and failure messages as soon as they appear.

Turn the click-wheel to scroll forward and backwards through the logbook.

Push the click-wheel on "ESC" for return to the main display.

7. Configuration Menu



Push the click-wheel to open the main menu.

The access to the main menu is protected by a passcode:

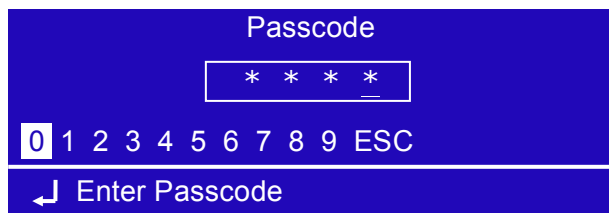

Select a four-digit number-code. As soon as the fourth correct digit is selected the main menu opens automatically.



Caution!

- Access to the main menu for authorized service technicians only!
- The passcode is stored in appendix A: "Test Certificate" or you find it in chapter „7.7 System Settings“ (factory defaults).

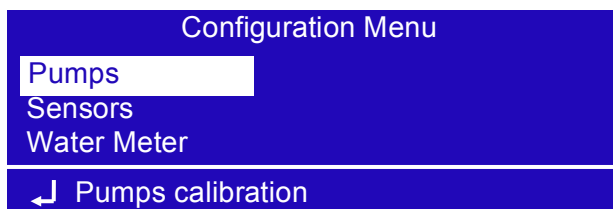

Sub-menus:

- Calibration of the dosing pumps
- Calibration of the chlorine dioxide and temperature probe
- Configuration of the input for a water meter

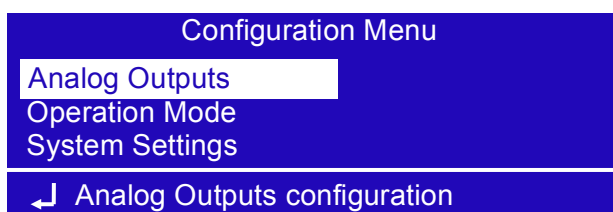

- Configuration of the analog outputs
- Selection of operation mode
- System settings

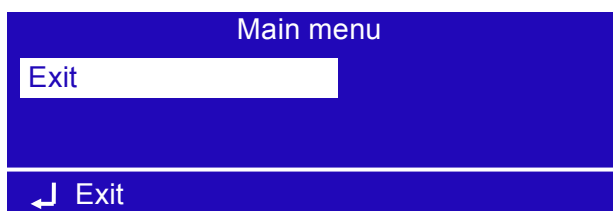

- Back to main display

7.1 Pumps – Calibration of dosing pumps

For an accurate production of chlorine dioxide a proper calibration of the dosing pumps is essential. The exact calibration ensures the maximum yield of the chemicals and the minimization of the chemical consumption. For this a periodic maintenance with a pumps calibration is required.

A calibration has to be executed:

- At the first startup or restart after a shut-down period.
- At every periodic maintenance.

Calibration:

1. Remove the protection caps from the calibration cylinders.
2. Shut the ball-valves 5.3 and 6.3 from the suction lines.
3. Open the ball-valves 5.2 and 6.2 from the calibration cylinders-
4. Fill the calibration cylinder with water until the "0 ml" tag.
5. Go into the "Priming" mode and vent the suction hose of the calibration cylinders.
6. Refill the calibration cylinder until the "0 ml" tag.

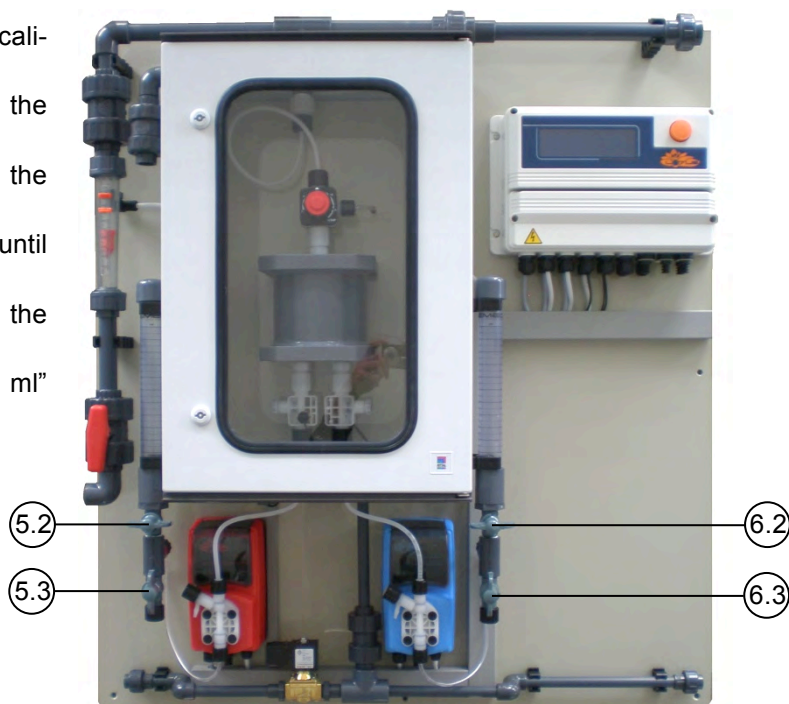

7. Enter the Main menu and open the sub-menu "Pumps".

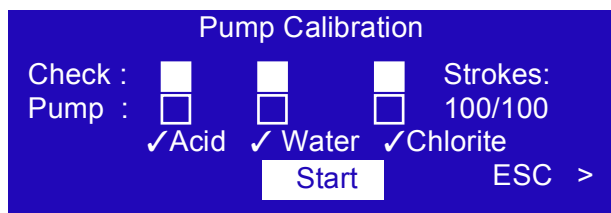
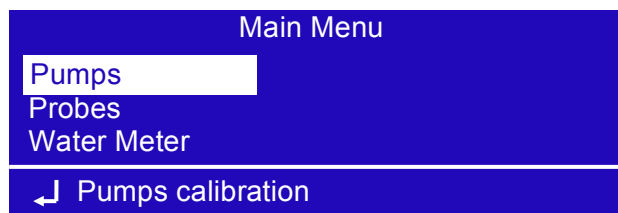

8. Push the click-wheel on "Start".
Both dosing pumps are executing 100 strokes (see the count-down in field "Strokes"). An additional display opens when they finished.
9. Read the "ml"-level from the calibration cylinder and insert the values into the input-fields for the two pumps. Ignore the input-field for "Water".

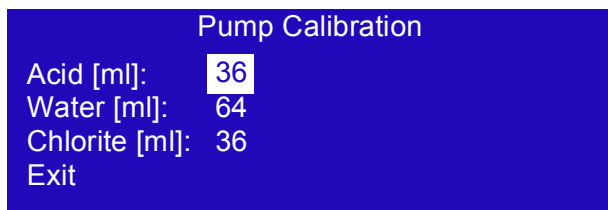

**"WATER"
IN PUMP CALIBRATION
ISN'T AVAILABLE ON
LOTUS MAXI 240**

10. Change the ball-valves back into operation position and plug the protection caps onto the cylinders.
11. ✓ This symbol enable calibration mode for each dosing pump

7.2 Sensors – Calibration of the chlorine dioxide probe and temperature sensor

See appendix D: Operation mode „*Proportional & Measuring*“.

7.3 Contact water meter

For the proportional production of the chlorine dioxide the connection of a contact water meter is required.

The LOTUS-controller can work with the following types of water meters:

- Contact water meter with Reed-contact (like type CTFI)
- Contact water meter with open collector
- Water meter with analog output 4...20 mA (like a magnetic flow meter)

In the sub-menu „Water Meter“ LOTUS can be optimal adapted to the connected water meter.

Enter the main menu and open the sub-menu “Water Meter”.

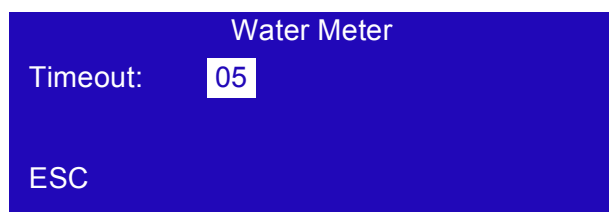
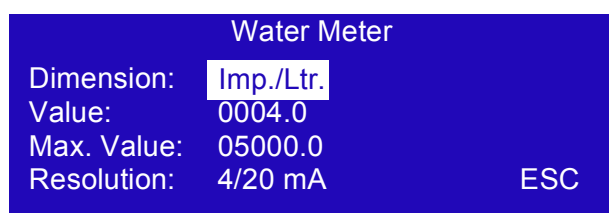
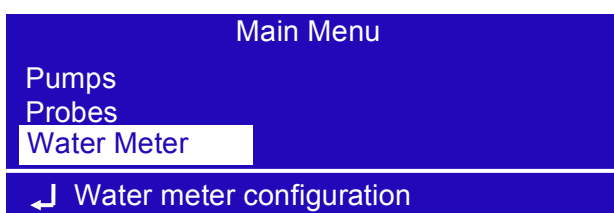

Dimension: Select the dimension you want to insert in field “Value”. Chose between pulse per liter „Imp./Ltr.“, or liter per pulse „Ltr./Imp.“.

Value: Insert the pulse spacing (see also chapter 4.4.1).

Max. Value: This input is only for water meters with analog output (0/4...20 mA). You have to insert the maximum flow of the water meter in m³/h corresponding to 20 mA.

Resolution: Here you have to select the type of analog output of the water meter. You can chose „0/20 mA“ or „4/20 mA“.



Notice:

This function is activated only in case the option “Analog” was ordered.

Timeout: The “Timeout” function acts as an optimizer for the proportional mode in case a contact water meter is connected to LOTUS and

- a) The flow is fluctuating very strong in short periods
- b) The pulse spacing of the water meter is extreme inconvenient.

The range is between 0 – 20 seconds. “0” deactivates the function.

What is the principle?

As soon as the first pulse from the water meter is noticed, Lotus starts the production with 100% capacity (= maximum stroke frequency). Parallel the controller is counting the time until the next pulse appears. With this information LOTUS can calculate the flow and the required production capacity to readjust the stroke frequency for the pumps.

In case the water meter produces more pulses than LOTUS is able to produce chlorine dioxide proportional to the flow (failure message “OVERFLOW”), the controller buffers the pulses and execute them later. But only for the timeout span to avoid overdosing in case the water flow stops immediately during the timeout.

7.5 Analog outputs

There are 2 analog outputs available for the chlorine dioxide and the temperature measuring values. In case LOTUS is equipped with the option you can select the output resolution in this sub-menu.

Enter the main menu and open the sub-menu "Analog Outputs".

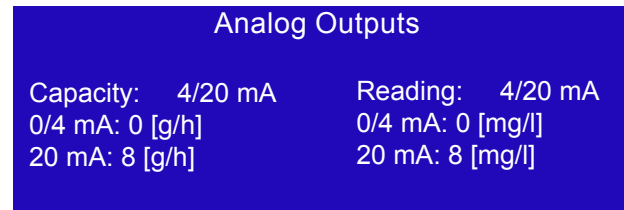
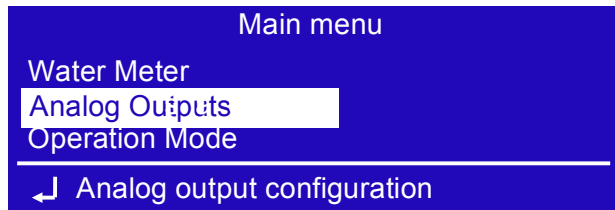

Capacity: Here you have to select the analog output value based on production gr/h.

Choose between 0/20 or 4/20 mA.

Reading: Here you have to select the analog output value based on ClO₂ probe reading.

Choose between 0/20 or 4/20 mA.

CURRENT OUTPUT VERSION (mA) main board blocks:

Capacity: 13 (-) ; 15 (+)

Reading: 13(-) ; 16(+)

7.5 Operation mode

LOTUS can work in different operation modes.

Enter the main menu and open the sub-menu "Operation Mode".

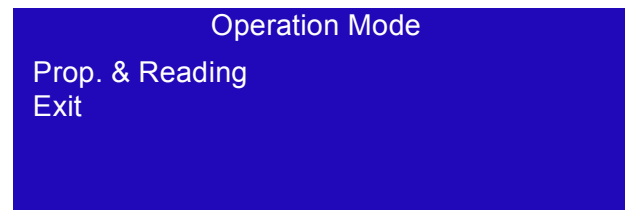
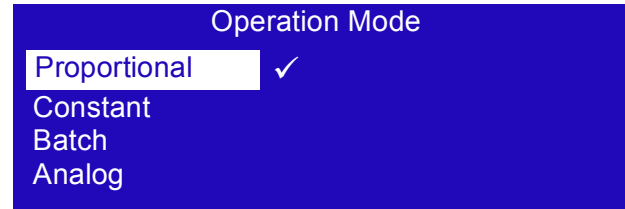
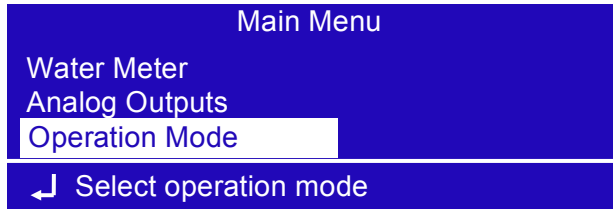

Proportional: In this mode LOTUS produces an adjustable capacity of chlorine dioxide proportional to a water flow recorded by a water meter.

Constant: In this mode LOTUS is producing chlorine dioxide with a constant and adjustable capacity as long as input "Stand-by" is not activated.

Batch: In this mode LOTUS fills up a level-controlled batch tank with chlorine dioxide in an adjustable concentration.

Analog: In this mode the chlorine dioxide production capacity is controlled by an external analog signal (0/4 – 20 mA).

Prop. & Reading: In this mode LOTUS produces an adjustable capacity of chlorine dioxide proportional to a water flow recorded by a water meter. In addition a internal chlorine dioxide measurement controls the concentration and downsizes the production capacity in case of an set-point overriding.



Notice:

The "Prop. & Reading" mode is available only if a "Lotus Maxi with probe" option is ordered

Operation Mode (options)

Production: within this menu user can choose dioxide production gr/h (grams per hour) based on maximum controller capacity

Proportional CI: dosing activity based on ClO₂ setpoint

7.5.1 Proportional mode

In the proportional mode LOTUS produces an adjustable capacity of chlorine dioxide proportional to a water flow recorded by a water meter.

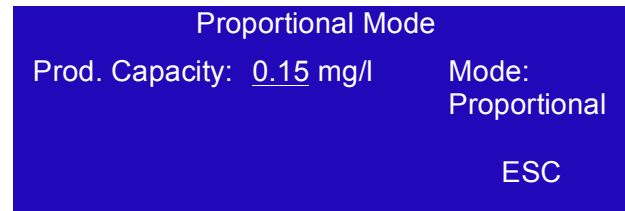
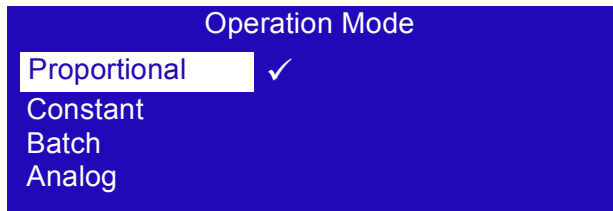

Prod. Capacity: Here you can adjust the requested chlorine dioxide concentration.



Warning:

- The controller takes the inserted value in “*Prod. Capacity*” for the calculation of the required stroke frequency of the dosing pumps for the production of chlorine dioxide proportional to the flow. This means that it is a theoretically value and not the real concentration in the water!
- The operator is responsible by its own for the proper adjustment of this control-value!
- The operator has to countercheck the chlorine dioxide concentration in the connected water system with a suitable photometer to verify the real concentration and to readjust the “*Prod. Capacity*” until the required concentration is stable achieved.



General Notices:

Theoretically it is possible to adjust the production capacity up to 9.99 mg/l.

But for very low water flows, resp. water consumption it can be dangerous to do this and should be absolutely avoided!

The overriding of the maximum possible production capacity caused by the water flow is shown on the display with a special blinking message “*Overflow*”:

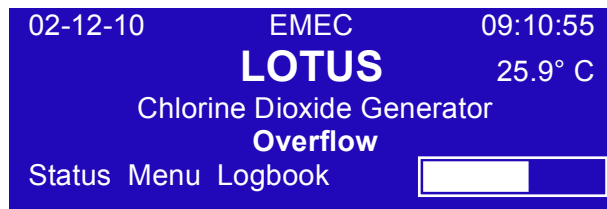

As soon as the water flow drops down under the maximum acceptable value, the message disappears.

7.5.2 Constant mode (chlorine probe not used)

In this mode LOTUS is producing chlorine dioxide with a constant and adjustable capacity as long as input “Stand-by” is not activated. Two different capacities can be adjusted depending to the digital inputs “Stand-by” [terminal 54 and 55].

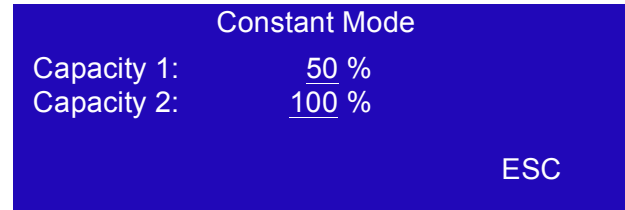
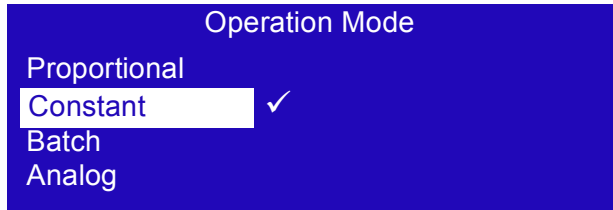

Capacity 1: In this field you can adjust the production capacity for the digital input “Batch tank empty”.

Capacity 2: In this field you can adjust the production capacity for the digital input “Stand-by”.

Situation	STAND-BY (54; 55)	SEPR (39, 40)
LOTUS “STAND-BY”	— ● ● —	
Capacity 1		— ● ● —
Capacity 2		— ● ● —



Notice:

The digital input extension module (MD DI) is an option.
In case the option is not implemented, only the function “Capacity 1” is active!

7.5.3 Batch mode (chlorine probe not used)

In this mode LOTUS fills up a level-controlled batch tank with chlorine dioxide in an adjustable concentration. The two digital inputs "Batch tank empty" [terminal 39 and 40] and "Stand-by" [terminal 54 and 55] are used for the level-control.

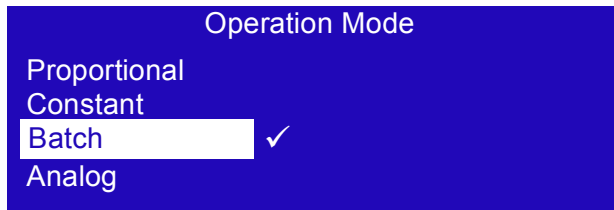

Situation	Step	SEPR 39, 40	Tank empty	Standby 54, 55	Tank full
Tank empty (filling)	1		<input type="checkbox"/>		<input type="checkbox"/>
Level is rising (filling)	2		<input checked="" type="checkbox"/>		<input type="checkbox"/>
Tank full	3		<input checked="" type="checkbox"/>		<input checked="" type="checkbox"/>
Level falls down	4		<input checked="" type="checkbox"/>		<input type="checkbox"/>
Tank empty	1		<input type="checkbox"/>		<input type="checkbox"/>



Notice:

The digital input extension module (MD DI) is an option. In case the option is not implemented, only the function "Tank empty/full" is active!

Step 1:

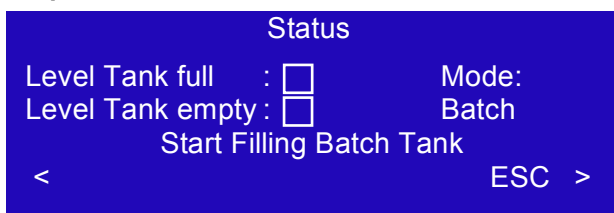

Step 2:

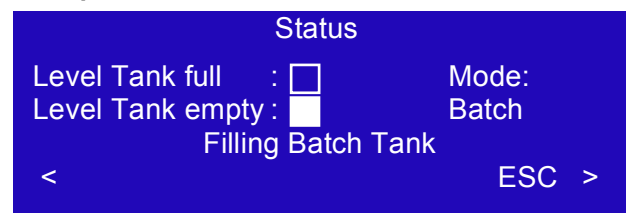

Step 3:

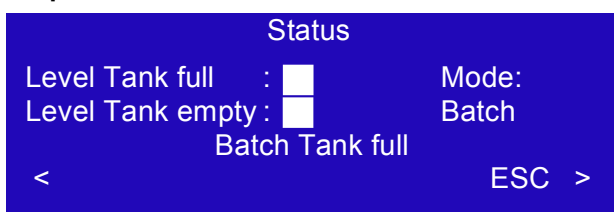

Step 4:

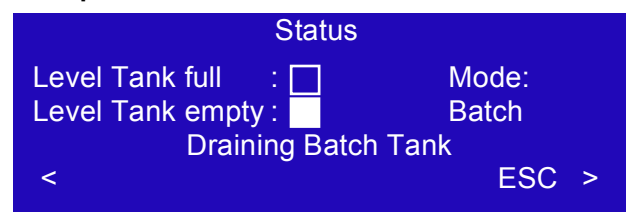

In case one of the level-switch failed or the cable is damaged a failure message appears:

Failure Level-switch:

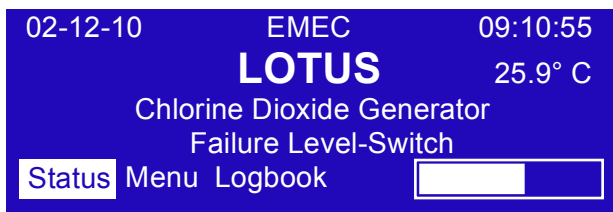
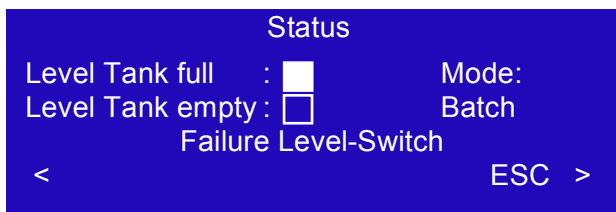

7.5.4 Prop. & Reading mode

In this mode LOTUS produces an adjustable capacity of chlorine dioxide proportional to a water flow recorded by a water meter. In addition an internal chlorine dioxide measurement controls the concentration and downsizes the production capacity in case of an set-point overriding.

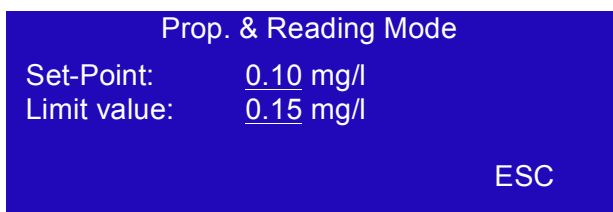
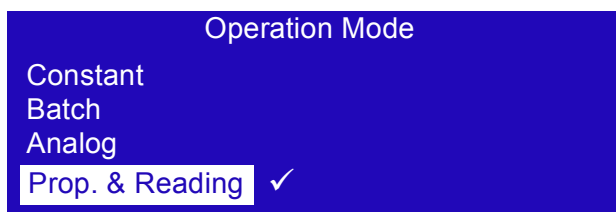

Set-Point: Here you can adjust the requested chlorine dioxide concentration before LOTUS is readjusting the production capacity.

Limit value: Here you can adjust the maximum acceptable concentration before LOTUS downsizes the production capacity.



Notice:

The "Prop. & Reading" mode is available only in case the option is ordered.

7.6 System settings

This menu is for basic settings.

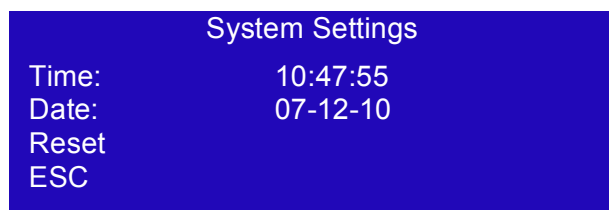
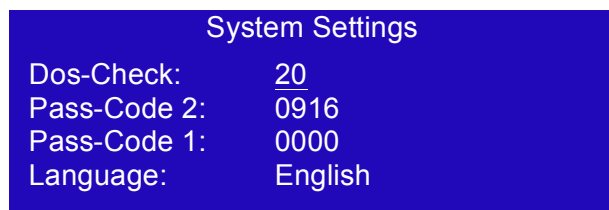
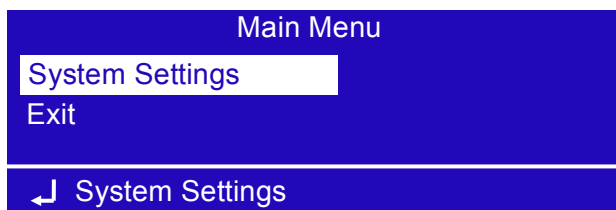

Dos-Check: Here you can preset the number of failed strokes from the dosing pumps without response from the dosing controls. When the controller counts this number LOTUS stops and a failure message appears.
Setting range: 10 – 50.

Pass-Code 2: This passcode activates **the main menu** and is dedicated for the authorized service technician only!
Here you can change the passcode. It is active as soon as you exit to the main display.
Setting range: 0000 – 9999. **Default value: “0 9 1 6”.**



Caution!

Write the new passcode down in your documents or into the „Test Certificate” (appendix A) for later using!

Without the passcode you cannot open the main menu again!



Notice:

Executing a “Reset” (see below) sets the passcode back to the default value “0 9 1 6”.

Pass-Code 1: This passcode is for the operator. It activates an additional display where he can readjust the production capacity depending to the activated operation mode.

Here you can change the passcode during startup by the demand of the operator. It is active as soon as you exit to the main display.

Setting range: 0000 – 9999. **Default value: “0 0 0 0”.**

Language: Here you can select the language for the display.
You can chose English or German.

Reset: In this display you can execute a reset to the factory default values.

Time: Here you can adjust the internal clock for the time stamps in the logbook.
Date:

PROBE: It is possible to enable the reading and the related alarms of the dioxide probe also for the working modes that normally do not need reading of the dioxide: COSTANT, BATCH and PROPORTIONAL + WM.

Connections to the mainboard

Before performing any operation on the Block board of the instrument, it is mandatory to disconnect it from the mains. To facilitate the connections to the mainboard, it has been divided into two blocks: electrical connections and I/O connections.



Unplug power cable from main power supply before operate

Danger

Blocks numbering is relative to the area on which you are working!

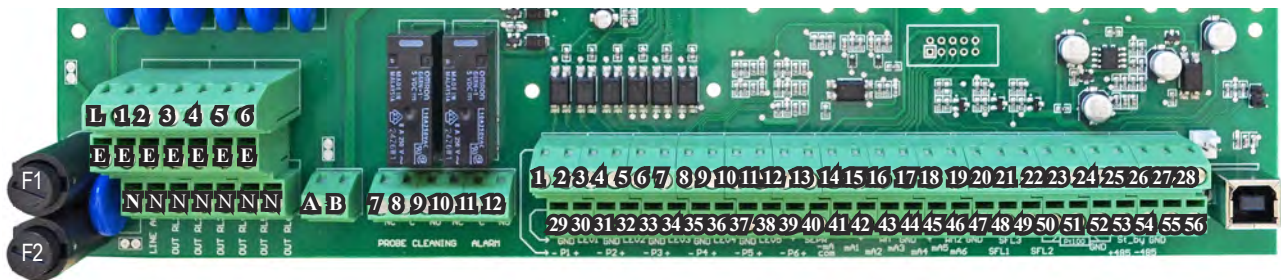

Electrical Connections



I/O Connections

Electrical connections:

F1: Main fuse (6.3AT)
 F2: Instrument fuse (3.15AT)

MAIN POWER SUPPLY (115VAC / 240VAC): L(Phase), E(Earth), N(Neutral)

SET-POINT OUTPUTS (115VAC TO 240VAC):
 (free contact outputs are not protected with a fuse and isolation between the outputs and the power supply is 250V MAX):

- | | |
|-----------|--------------------------------------|
| 1 - E - N | (F2 Fuse-protected) BYPASS PUMP |
| 2 - E - N | (F2 Fuse-protected) VENTILATION PUMP |
| 5 - E - N | (F2 Fuse-protected) ALARM Out |

GENERAL ALARM OUTPUT:

10(N.C.), 11(C), 12(N.O.)

I/O Connections:

OUTPUTS FOR DIGITAL SIGNAL PROPORT. PUMP:

1(-) ; 2(+): Acid pump signal output
3(-) ; 4(+): Chlorine pump signal out

INPUTS:

21(-) ; 20(+): SEFL1
23(-) ; 22(+): SEFL2
49(-) ; 48(+): BYPASS Line

MA OUTPUTS (MAX LOAD 500 OHM):

mA Outputs Active – Do not connect any external voltage - Driver voltage without load: 15V

13: Common
15: Production
16: Reading

RS485:

26: + Signal 485 (A)
27: - Signal 485 (B)

TANKS LEVEL INPUT:

29(-) ; 30(+): LEAKAGE
35(-) ; 36(+): ACID
37(-) 38(+): CHLORINE

FLOW sensor (mod. "SEPR") input: 39(+ Brown) ; 40(Black) ; 41(- Blue)
41 shortcut with block n.37

CONTACT input: 39(White) ; 40(Black)
41 shortcut with block n.37

OVERFLOW BATCH TANK CONTACT: 31(-) ; 32 (+) level overflow (batch mode only)

(Hall effect) pulse sender water meter (makeup water): 42(+12VDC) ; 43(INPUT) ; 44(GND)
(Contact) Pulse sender water meter (makeup water): 43(INPUT) ; 44(GND)

Temperature Probe input (mod. "ETEPT"): 50(green) ; 51(brown) ; 52(white) ; 53(yellow)
(remove resistance before to install probe)

Temperature Probe input (PT100) with ECDIND probe: 50(green) ; 51(orange or pink) ; 52(white) ; 53(yellow)

STANDBY input: 54(+) ; 55(GND)* *BATCH TANK FULL / CAP1 CONSTANT

OVERFLOW Batch Tank 31(-) ; 32(+)

8. LOTUS Terminal board

Probe modules connection

At the top of the mainboard there are 4 adaptors for the installation of the probe modules and inputs. Upon request, these modules are installed by the manufacturer. For proper installation, check the installed modules and implement the required connections. A standard Ethernet cable (RJ45) is required for the ETHERNET version (module with red circle).

Attention: all connections must be executed by qualified personnel

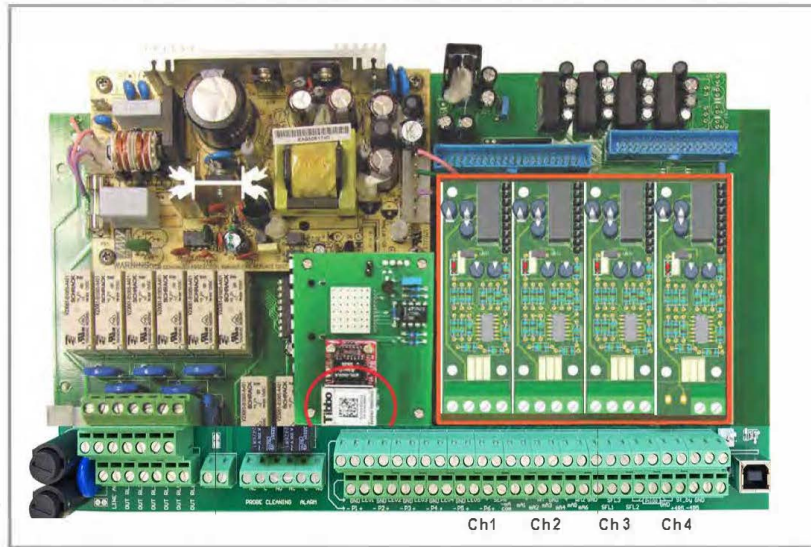

Danger

Unplug power cable from main power supply before operate



ORP Version on Slot 3

Connect mV here!

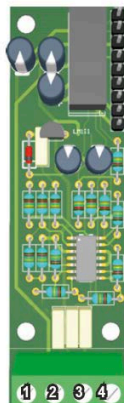

DIOSIDE SENSOR Ch2

Connection:

Block 1 : (+12VDC) Brown
Block 2 : (-12VDC) White
Block 3 : (V-out) Green
Block 4 : (GND) Yellow

To set the proximity switch enter into configuration menu and select "Probe FlowAlarm".

Flow contact can be enabled to stop a dosing procedure using a N.O. contact mode (normally open) or N.C. contact mode (normally closed) when status on blocks changes. Rotate wheel to choose between: "DISABLE", "REVERSE" (N.O. contact) or "DIRECT" (N.C. contact).

Furthermore "Flow contact" can starts after a specified time when contact status changes. To set it move wheel on "Time:00 min", click it and rotate to choose time (from 0 to 99 minutes). Confirm selection by clicking wheel. This function is available only with CI module installed.

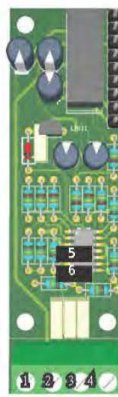

MDCL Ch3

CI probe connection:

ECL2/2
ECL2/20
ECL17/10
ECL18/10
Jumpers: 5 and 6 open
Block 1 : (+) Brown
Block 2 : (-) White
Block 3 : (IN) Green
Block 4 : (GND) Yellow

ECL4
ECL5
ECL6
ECL7

Jumpers 5 and 6 closed
Block 3 : (-) Black
Block 4 : (+) Red



MDMA Ch4

Flow sensor module (mA) connection:

Block 1 : (+) Red
Block 2 : (-) Black

9. Configuration Menu Summary

Configuration Menu

Pump Calibration
Sensors
Water Meter
Analog Output

Configuration Menu

mA Input
Bypass Alarm
Probe Flow Alarm

PUMP CALIBRATION

See chapter 7.1

SENSORS

See chapter 7.2

WATER METER

See chapter 7.3

ANALOG OUTPUT

See chapter 7.5

mA INPUT

Set this function to calibrate Water Meter function with current input. Two calibration points are required: P1 & P2.

BYPASS ALARM

Set this function to enable alarm for NO MAIN FLOW (from bypass water) and set time for automatic RESTART.

PROBE FLOW ALARM

To set the proximity switch enter into configuration menu and select Probe Flow Alarm
Flow contact can be enabled to stop a dosing procedure using a N.O. contact mode (normally open) or N.C. contact mode (normally closed) when status on blocks changes. Rotate wheel to choose between: "DISABLE", "REVERSE" (N.O. contact) or "DIRECT" (N.C. contact). Furthermore "Flow contact" can starts after a specified time when contact status changes. To set it move wheel on "Time:00 min", click it and rotate to choose time (from 0 to 99 minutes). Confirm selection by clicking wheel.

Inputs:

Block, Terminal	Function	Electrical data
X4: 24, 25	Dosing control "SEFL Acid"	for contacts or switching transistors: Open circuit voltage: 12V Short circuit current: 5 mA
X4: 26, 27	Dosing control "SEFL Chlorite"	
X4: 28, 29	Control switch "Bypass line"	
X4: 30, 31	Level switch "Acid"	
X4: 32, 33	Level switch "Chlorite"	
X4: 34, 35	Level switch "Leakage"	
X4: 38, 39	Digital input for contact water meter with reed-contact	Frequency range: 0.25 ... 20 Hz Supplied open circuit voltage: 12 V Switching point: 4 k Ω
X4: 37, 38, 39	Digital input for contact water meter with Hall sensor	Contact gap: 1 ... 1200 pulse/liter
X4: 38, 39	IDM with open collector	Frequency range: 10 ... 10000 Hz Pulse width: > 20 μ s
X4: 44, 55	External contact "Stand-by"	for contacts or switching transistors: Open circuit voltage: 12V Short circuit current: 5 mA

Outputs:

Block, Terminal	Function	Electrical data
X1: 01, E, N	Switched mains relay "Bypass pump"	5 A constant current
X1: 02, E, N	Switched mains relay "Ventilation unit"	1 A constant current
X1: 05, E, N	Switched mains relay "Alarm"	1 A constant current
X2: 07,08,09	Change over relay "System in operation"	250 VAC / 3 A / 100 VA
X2: 10,11,12	General "Alarm" Output 10(N.C.) - 11(C) - 12 (N.O.)	1 A constant current
X3: 01, 02	Frequency output dosing pump "Acid"	Voltage: 12V Frequency: 0 – 180 pulse/minute
X3: 03, 04	Frequency output dosing pump "Chlorite"	Voltage: 12V Frequency: 0 – 180 pulse/minute
X3 (A1): 13, 14	Measuring value "Chlorine dioxide concentration"	0/4...20 mA, potential-free Max. apparent resistance: 600 Ω
X3 (A2): 13, 15	Measuring value "Temperature"	0/4...20 mA, potential-free Max. apparent resistance: 600 Ω
X3 (A3): 13, 16	Plant capacity in "%"	0/4...20 mA, potential-free Max. apparent resistance: 600 Ω

10. Failure messages

In case of a malfunction a message appears on the display and LOTUS stops.

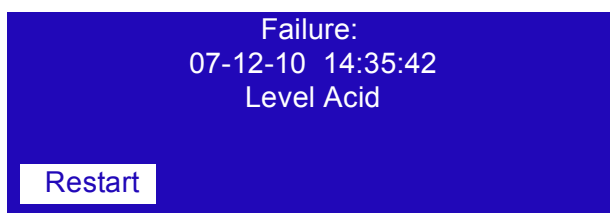

Remove the malfunction and restart LOTUS by pressing the click-wheel on “RESTART”.

Message	Problem	Solution
Level Acid	One of the chemical cans or the dilution water storage tank is empty.	Change the chemical can and prime the pump.
Level Water		Check the supply line for the dilution water storage tank. Prime the pump.
Level Chlorite		Change the chemical can and prime the pump.
Reactor Leakage	There is a massive leakage inside the reactor housing (3).	Leave the room immediately and shut the door! Shut down the plant with emergency stop switch. Wear complete personal protective equipment. Take attention to chapter “1.4 Safety Chapter” in Manual Part.1.
Contact Batch Tank Empty Level	The cable of the level-switch is disconnected or has a damage	Check the proper function of the level-switch.
Flow control Acid	A dosing control is recognizing lack of or no dosing.	Prime the corresponding pump. Readjust the flow-sensitivity at the dosing control.
Flow control Water		
Flow control Chlorite		
Contact SEFL Acid	A cable of the dosing control is damaged or disconnected.	
Contact SEFL Water		
Contact SEFL Chlorite		
Analog Input	The analog input signal is lower 3.5 mA.	Check the signal supply device. Check the signal cable for damages.

Message	Problem	Solution
Service required	The operation interval is lapsed	Call the Customer service - authorized by EMEC .



Notice:

The two alarm output relays (terminal 5-E-N) and (terminal 10 (NC) – 11 (C) – 12 (NO)) are switching on in case of a malfunction. The relays are falling off as soon as the removal of the malfunction is confirmed with the *“Restart”* button.

COMMUNICATION MENU (TCP/IP & GPRS)

This instrument can be controlled and programmed remotely using the system called ERMES and a standard web browser (i.e.: Google Chrome or Safari). In order to use this service an internet connection is required (lan or wan) and user must configure the instrument to obtain a valid IP address (through a valid DHCP service or manually). If this instrument is installed within an office network please contact your system-administrator to obtain required parameters and eventually unlock TCP/IP port 2020.

Things to do before setup.



Network administrator required

1. Ensure that on instrument MAC ADDRESS (see SERVICE menu) the TCP/IP port 2020 is unlocked. Check it with your system-administrator.
2. Connect to your ERMES account or create a new one at: www.ermes-server.com
3. Within ERMES account add the new instrument using the 6 digits code located into SERVICE menu. (choose LAN DEVICE or MODEM code based on connection type chosen prior to buy the instrument)

Parameters to be configured in the communication menu (TCP/IP)

In order to communicate **via LAN cable to ERMES** server the following parameters must be set:



Basic Network skills required

If configuration requires the presence of a ROUTER with automatic IP address assignment from TCP/IP menu select IP MODE and set it to DYNAMIC.

If local LAN needs to provide static IP address then from TCP/IP menu select STATIC IP MODE and enter the following parameters:

IP address: enter the unit unique available IP address using syntax xxx.xxx.xxx.xxx

SUBNET (netmask): range of belonging to the host within a subnet IP. For example: 255.255.255.0

GATEWAY: The IP address of the device that routes packets. For example: 192.168.1.1

DNS: IP address of the device that resolves the names of network nodes.
It is usually the same as the GATEWAY. It can be also a public DNS address (e.g.: 8.8.8.8)

Parameters to be configured in the communication menu (GPRS)

In order to communicate **via GPRS modem to ERMES** server insert SIM into modem's slot. A data plan subscription is suggested to reduce SIM costs. From GPRS menu set the following parameters:

Ermes SERVER: select YES to activate the traffic data with Ermes server or select NO to use the GPRS modem only for SMA and/or EMAIL alerts messages.

APN: ask SIM mobile company what is the name of the access point designated

APN Username & Password: ask SIM mobile company both these parameters

PIN: Enter the assigned 4 digits code to automatically unlock the SIM

COMMUNICATION (MESSAGES Setup - RS485)

This instrument can send emails and / or sms when a system failure or warning happens. If instrument is configured to operate through the LAN only email messages can be send. Otherwise if instruments has a mobile modem both SMS and emails messages can be send.

MESSAGES Setup

Within this menu is possible to setup up to three SMS (SMS1, SMS2, SMS3) recipients and two email (email 1, email 2) addresses. Editing MSG ALARM and MSG WARNING ALARM is possible to setup which type of error must be notified (see below table).

MSG warning	MSG alarm
MAXIMUM TIME REACHED	PROBE FLOW ALARM
HCl LEVEL	CHLORINE DIOXIDE IN STORAGE NO LONGER USABLE
NaClO ₂ LEVEL	SYSTEM NOT READY
ST.Tank Full	
SYSTEM NOT READY	

RS485 Setup

This instrument can be connected in a network of instruments via RS485 (max 32) to take advantage of a single modem or LAN connection for remote programming (through ERMES server) or local (ask your provider).

Make the cable connections as described in RS485 terminal blocks and then in the RS485 menu, set the RS485 unique ID NAME for each instrument.

CHECK if entered in ID NAME has been properly accepted by clicking on ID CHECK, if an error message is reported by the instrument modify it.

COMMUNICATION (LOG MENU & LOGBOOK MENU)

This function, when enabled, allows to record and send to ERMES server all instrument activities (date, time, temperature, levels, alarms, totalizers, outputs status) for a set period (EVERY) and starting from a certain time (TIME) .

Note: SET TIME AND DATE PRIOR TO ENABLE THE LOG. If not fed after 30 days the instrument will lose current date and time.

TIME: log starting time (format 23h 59min)

EVERY: frequency of recording (format 23h 59min)

E.g.: To set the instrument to begin logging events starting from 16:00 every hour set TIME to 16h: 00 and EVERY of 1h: 00m

Note: To view on instrument's display the archived logs select LOGBOOK

ERMES

The web-based application ERMES allows plants remote control: with it is possible to read, analyze and modify instruments parameters from PCs, smartphones or tablets.

PLUS

- It reduces plant intervention and inspections.
- It reports on the current status of the network's devices and connections (probes, outputs, alarms, setpoints)
- It instantly gives notification of alarms by sms or email
- It generates an up to date report of all plant instruments
- It can display the instruments activity log as line graphs and charts and it can download it to your pc in excel or pdf format

HOW TO USE WEB ERMES

Enter the website www.ermes-server.com and, after registration, set plants.

EMEC instruments with ETHERNET or GSM/GPRS Configuration will be immediately connected and available for remote control. Furthermore, with ERMES you can receive alarm messages via email, with different report option on instrument status. If instrument has been bought with the GSM/GPRS option it's possible to receive SMS reports on any mobile phone.

Read "COMMUNICATION" chapters to better understand how to configure the instrument.

Troubleshooting

Problem	Possible solution
<p>What to do before to install the SIM into instrument's modem</p>	<p>Check best signal coverage for operator choice.</p> <p>Modem is compatible with the following GSM frequencies: 900 -1800 -1900 MHz (three-band). Not compatible with 3G only operators.</p> <p>SIM type is: Mini-SIM (classica SIM card in uso nei telefoni) Lenght 25 (mm) - Width 15 (mm) - thickness 0,76 (mm)</p> <p>Subscribe to a data plan for monthly traffic activity of about 500MB</p> <p>Make sure PIN REQUEST is OFF. If not insert SIM into a standard mobile phone and disable it.</p>
<p>Several instruments are connected in RS485 mode but the software displays only one</p>	<p>Make sure the termination jumper on the first and last instrument of the chain are closed</p>
<p>The GPRS modem does not connect to the network</p>	<p>Verify the correct insertion of the SIM</p> <p>Verify APN parameters and enter them manually if necessary</p> <p>Make sure the SIM has a data plan active for internet access</p> <p>Make sure the provider supports international roaming DATA if the connection is abroad</p>
<p>The instrument is unable to obtain a valid IP address from the LAN or the software does not connect to it</p>	<p>Make sure the pre-existing network allows auto-assignment of the IP address (automatic DHCP); if it does not, contact the network administrator to obtain the data to enter manually</p> <p>Make sure the network cable is connected to the instrument. Make sure it is a good quality cable and not the "cross" type. CAT 5, 6 and 7 cable types are compatibles</p>
<p>ERMES does not find the instruments via internet that are correctly connected to a LAN</p>	<p>Make sure the internet connection is active</p> <p>Make sure there are no port-blocking third part programs and/or firewalls active that prevent data traffic through the TCP 2020 port</p>
<p>FIRST TIME CONNECTION TO ERMES</p> <p>ERMES is asking for CODE and SERIAL NUMBER during first time access, where are they ?</p>	<p>CODE and SERIAL NUMBER are located on instrument's main label</p>
<p>ADDING AN INSTRUMENT TO ERMES</p> <p>Where is the CODE NUMBER required to add an instrument to the account?</p>	<p>For instrument with LAN access: see SERVICE menu within instrument's software</p> <p>For instrument with GPRS access: enter SIM phone number</p>

MODBUS

Modbus is a serial communications protocol originally published by Modicon (now Schneider Electric) in 1979 for use with its programmable logic controllers (PLCs). Simple and robust, it has since become a de facto standard communication protocol, and it is now a commonly available means of connecting industrial electronic devices.

From main menu select COMMUNICATION then MODBUS to access the options. Set the communication speed according to the PLC system available. Set the ID assigning an UNIQUE address to avoid conflict .

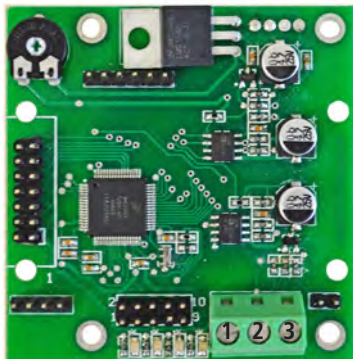
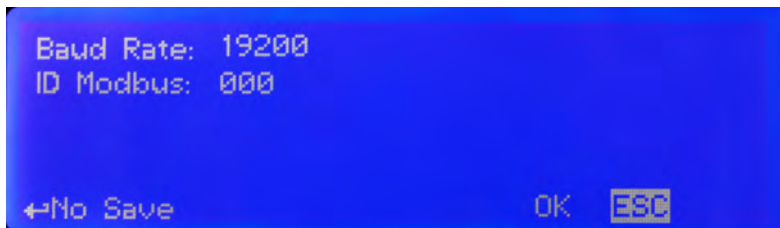

To access the module MODBUS open the instrument only after power is switched off!

Never make connections with the instrument powered!



WARNING

- 1: GND
- 2: A-RS485 (+)
- 3: B-RS485 (-)

ADDENDUM DIOXIDE PROBE SAFETY SYSTEM

Dioxide Probe

Use this function to setup sensor that detects dioxide into air. This option is useful during a plant's dioxide leakage to prevent dangerous high dioxide concentration. To set this value refer to the sensor sensitiveness as printed on head's label (see below picture). **Do not edit this function if not otherwise specified or if unsure of value to enter.**

Other options are:

MAIN MENU: HIDE to not show a warning message. Use exclusively if no sensor is connected.

MAIN MENU: SHOW to enable warning message and related alarm on main screen. Enabled by default.

Attention: this procedure assumes that the instrument is configured properly and connected to a working sensor, otherwise the results may not be reliable.



Dioxide into air main sensor head

Dioxide into air alarm

Use this menu to set a maximum dioxide into air concentration value into environment. Don't change this value if unsure of value to enter. **Do not edit this function if not otherwise specified.**

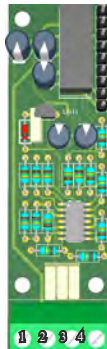

Connection:

Block 1 : (+12VDC) Brown

Block 2 : (-12VDC) White

Block 3 : (V-out) Green

Block 4 : (GND) Yellow

**SLOT 2
DIOXIDE SENSOR MODULE**

Chlorine Dioxide Generator LOTUS MAXI



Installation and Operation Manual



**Read this manual completely before you start with the installation and start-up.
Do not discard this manual and store it nearby the generator for later use.**



This manual contains important information about the installation and operation safety.
Take care about the following instructions to avoid personal injuries and material damages!
The operator is responsible in case of damages caused by installation and operation failures!



English

R4-03-15



Directory

1.	General Safety Guidelines	4
1.1	General remarks	4
1.2	Symbols in the manual	4
1.3	Symbols at the installation site	4
1.4	Safety chapter	5
1.5	EU Declaration of Conformity	8
2.	Storage and Transport	9
3.	Construction	10
3.1	General description	10
3.2	System overview	11
3.3	Reactor overview	12
4.	Installation	13
4.1	General requirements for the installation location	13
4.2	General requirements for the plant installation	13
4.3	Requirements to the water	14
4.4	Assembling	14
4.5	Hydraulic installation	15
4.5.1	Installation example A	16
4.5.2	Installation example B	17
4.5.3	Installation example C	18
4.5.4	Installation example D	19
4.6	Hydraulic Installation of accessories and options	20
4.6.1	Bypass line	20
4.6.2	Safety equipment bypass line	20
4.6.3	Flushing unit with vacuum relieve valve	21
4.6.4	Back pressure valve	21
4.6.5	Flow generator for bypass	21
4.6.6	Module "Ventilation unit"	22
4.6.7	Module "Water supply"	22
4.6.8	Suction lances	23
4.7	Electric Installation	24
4.7.1	Power supply	24
4.7.2	Installation of an emergency stop switch	24
4.7.3	Connection of the bypass pump	25
4.7.4	Installation of a gas detector	25
4.8	Placing of warning labels	25
5.....	Manual Part 2: Startup and Operation	...
9.	LOTUS Terminal board	31
10.	Technical Data	32

1. General Safety Guidelines

1.1 General remarks

This manual includes basic directions for the assembling, operation and maintenance. Therefore it is obligatory for the assembly technician as well as for the operator to study the complete manual before starting with the installation and start-up.

- This manual must be present at the generator at any time.
- It is also obligatory for the operator to consider the general directions in chapter “Safety instructions” as well as the specific safety instructions included in the other chapters of this manual.



Notice:

- For some of the following described functions additional accessories (not included in the delivery scope of LOTUS) may be required.
- Depending to the software release of the LOTUS-controller some of the described features may not be available. Or some functions are available, but not described in this manual. Please contact your dealer in case of the requirement for more information.

1.2 Symbols in the manual

In accordance to the guideline DIN 4844-W9 about the characterization of special risks all safety instructions in this manual are labeled with the following symbols:



Warning:

This symbol is warning about risks.
Disregarding may cause heavy personal injuries, death and material damages.



Caution!

This symbol is warning about troubles caused by incorrect operation.



Notice or advice:

This symbol shows important additional information.

1.3 Symbols at the installation site

In accordance to the guideline DIN 4844-W9 and DIN 4844-2 about the characterization of special risks and prohibitory signs, different areas of the installation site have to be labeled with the following symbols:



Warning:

Corrosive substances – label is located at the LOTUS plant



Danger!

Toxic substances – label must be located at the entrance, outside of the installation room



Prohibition!

No Fire, naked light – label must be located at the entrance, and smoking outside of the installation room

1.4 Safety chapter

The three basic rules:



1. The two components acid (diluted HCl) and chlorite (diluted NaClO₂) must never be brought into contact except in the reactor!
Otherwise poisonous ClO₂ gas forms abruptly and can then decompose explosively!
2. Never operate the chlorine dioxide generator LOTUS with undiluted acid or undiluted sodium chlorite!
Otherwise poisonous ClO₂ gas forms abruptly and then decomposes explosively within the reactor!
3. The bypass water must never be exposed to a vacuum pressure!
Otherwise the ClO₂ solution in the reactor is placed under a vacuum, the ClO₂ is degassing, forms a richer mixture and can decompose explosively!

Correct and proper use:



- The LOTUS system is intended solely for producing a ClO₂ containing disinfectant solution from diluted hydrochloric acid (9 %) and sodium chlorite solution (7.5 %) and for dosing it into a bypass line together with water.
- The LOTUS system is not designed for treating liquids (other than water) or gaseous media as well as substances with ClO₂!
- Any other uses or modifications to the system are prohibited!
- The system must not be operated under conditions other than those described in the technical data!
- The un-appropriate use affects the safety function of this generator and other connected devices and is therefore strictly forbidden.
- Do not allow untrained personnel to operate the LOTUS D system! All other activities should only be carried out by trained and authorized personnel, see the following table!
- Assembling and maintenance has to be done by authorized technicians only.
- Maintenance repairs have to be executed only by the manufacturer or authorized technicians. Interventions or changes at the device in opposite to the regular maintenance in accordance to this manual are incorrect and make the all warranty claims nugatory.
- The operator is liable for the observance of the local safety instructions.
- For the operation and service the device must be accessible at all times.
- You are obliged to observe the information contained in the operating instructions at the different phases of the system's service life!
- Please observe the relevant national regulations and guidelines at every phase of the system's service life!
- Take attention to the chemical safety data sheets!
- Wear protection clothes for the handling with hazardous chemicals.

Qualification of personnel:



Warning!

According to accident statistics, holiday replacements are a safety risk. Holiday replacements must also hold the below named qualifications and have been instructed accordingly.

Activity	Qualification level
Installation, installation of hydraulic system	Technical personnel
Electrical installation	Electrician
Initial commissioning	Customer service - authorized by EMEC
Start up	Technical experts
Operation, canister replacement	Instructed personnel
Maintenance, repair	Customer service - authorized by EMEC
Decommissioning, disposal	Technical experts
Troubleshooting	Customer service - authorized by EMEC , technical experts, instructed personnel (fault-dependent)

Technical expert:

A technical expert is deemed to be a person who is able to assess the tasks assigned to him and recognize possible hazards based on his/her technical training and experience, as well as knowledge of applicable regulations.

Qualified personnel:

A qualified employee is deemed to be a person who is able to assess the tasks assigned to him and recognize possible hazards based on his/her technical training, knowledge and experience, as well as knowledge of pertinent regulations.

Instructed personnel:

An instructed person is deemed to be a person who has been instructed and, if required, trained in the tasks assigned to him/her and possible dangers that could result from improper behaviour, as well as having been instructed in the required protective equipment and protective measures.

Customer service department:

Customer service refers to service technicians who have received certificated training and have been authorized by EMEC to work on the system.

Personal protective equipment



Wear eye protection (minimum outfit)
Wear face shield



Wear protective gloves (ClO₂-resistant type!)



Wear protective apron



Wear rubber or plastic boots

Safety information:



Warning!

Danger from incorrect operation

Incorrect operation can result in dangerous conditions for the system and its surroundings.

- The operating personnel must be instructed by an EMEC service technician. (undertaken during initial commissioning.)
- The operating instructions must be available by the system.



Warning!

Danger due to toxic and explosive ClO₂ gas

Under rare fault conditions ClO₂ solution can escape via a leak.

The installation of a gas detector is recommended to overcome this problem. The detector can switch off the system and create an alarm that is readily apparent from a distance. This ensures a safety operation with every ClO₂ system.

Instructions for entering a room where a chlorine dioxide system is installed

- Access only for trained personnel.
- If there is a smell of chlorine dioxide (pungent, chlorine-like smell) access is only permitted to personnel wearing the specified protective equipment.
- If there is a smell of chlorine dioxide, immediately switch off the system from a safe position, e.g. emergency stop switch, which is installed in a safe distance from the system.

Notes for the system operator in case of an emergency

- **You got into contact with acid:**
See the "EC acid safety data sheet" provided by the supplier!
- **You got into contact with chlorite:**
See the "EC chlorite safety data sheet" provided by the supplier!
- **You got into contact with ClO₂ solution or ClO₂ gas:**
See "Chlorine dioxide hazardous substance data sheet: Properties of chlorine dioxide and instructions for handling aqueous solutions" in this operating instructions, appendix!
- **An orange-yellow ClO₂ gas has escaped:**
Exit the operation room immediately and disconnect the power supply, (use the emergency stop switch)!
Wear complete personal protective equipment.
Take care that the gas is precipitated out of the atmosphere by using a water spray!
See also the data sheet "Chlorine dioxide hazardous substance data sheet: Properties of chlorine dioxide and instructions for handling aqueous solutions" in this operating instructions, appendix!
- **An orange-yellow ClO₂ solution has escaped:**
Exit the operation room immediately and disconnect the power supply, (use the emergency stop switch)!
Wear complete personal protective equipment.
Sprinkle pure sodium thiosulfate solution over the ClO₂ solution. Then dilute with lots of water and flush it away into the drain.
See also the data sheet "Chlorine dioxide hazardous substance data sheet: Properties of chlorine dioxide and instructions for handling aqueous solutions" in this operating instructions, appendix!
- **The LOTUS system was supplied with concentrated chemicals and the dosing pumps have pumped it already to the reactor inlet:**
Exit the operation room immediately and disconnect the power supply, (use the emergency stop switch)!
Contact immediately the fire and rescue service and explain them about the risk of an explosion due to concentrated ClO₂ gas!

ClO₂ gas can still explode after several hours!
See also the data sheet "Chlorine dioxide hazardous substance data sheet: Properties of chlorine dioxide and instructions for handling aqueous solutions" in this operating instructions, appendix!

- **The LOTUS system was supplied with concentrated chemicals but the dosing pumps have not yet started:**

Immediately switch the LOTUS system to „OFF“ or “Stand-by”!
Place the suction lances of both chemicals into separate buckets with water.
Arrange for the concentrated chemicals to be properly disposed off.
See also the data sheet "Chlorine dioxide hazardous substance data sheet: Properties of chlorine dioxide and instructions for handling aqueous solutions" in this operating instructions, appendix!



Directions for the operator

(Specific information for applicable regulations in Germany):

- Accident prevention regulation (UVV) „Chlorination of water“, GUV V-D5 E.
- „Dosing plants for chlorine dioxide“, DVGW [German Gas and Water Association] guideline W 624 (latest version respectively).
- „Chlorine dioxide in water treatment“, DVGW worksheet W 224 (latest version respectively).
- Directive for the protection of groundwater against pollution. (§ 19 Federal Water Act – WHG dated 23/09/1986).
- German Ordinance of hazardous substances (GefStoffV) – especially § 17 (obligatory protection) and § 20 (operation instruction).

1.5 EU Declaration of Conformity



The LOTUS generator is corresponding to the following EU-standards:

The following standards are considered:

- EU Machinery Directive (2006/42/EC)
- EU EMC Directive (2004/108/EC)
- Low-voltage directive 2006/95/EC according to Appendix I, No. 1.5.1 of the Machinery Directive 2006/42/EC
- EU Pressure Equipment Directive (97/23/EC)

The following harmonized standards are considered:

- EN ISO 12100-1, EN ISO 12100-2, EN 809
- EN 60206, EN 60529, EN 61000-6-1/2/3/4

The following harmonized national standards are considered:

- DVGW standards: Technical rules W 224 and W 624



Notice:

A declaration of conformity can be ordered from the manufacturer.

2. Storage and Transport

Safety information:



Warning!

- Return the device for repair only in a cleaned condition with emptied hydraulic components - refer to the chapter "Decommissioning"!
- Send the unit back together with a complete filled decontamination declaration form. The decontamination declaration is a decisive part of an inspection / repair order. A unit can only be inspected or repaired when a decontamination declaration form is submitted that has been correctly completed by an authorized and qualified person on the behalf of the operator.

The "Decontamination Declaration Form" can be print / found in the appendix or under www.emec.it



Notice:

Danger of material damage

The device can be damaged by incorrect or improper storage or transportation!

- The device should only be stored or transported in a well packaged condition - preferably in its original packaging.
- The packaged unit should also only be stored or transported in accordance with the stipulated storage conditions.
- The packaged unit should be protected from moisture and the ingress of chemicals.

Packaging:

The LOTUS chlorine dioxide system is supplied in a heavy cardboard box – wrapped with foam – on a palette

Ambient conditions:

Data	Value
Minimum storage and transport temperature	-10 °C
Maximum storage and transport temperature	+40 °C
Maximum air humidity (not condensing)	90° rel. humidity

3. Construction

3.1 General description

The chlorine dioxide generator is used for the production of liquid chlorine dioxide. This disinfection agent kills all bacteria, germs, viruses and fungi within shortest time – and it works with very low concentration.

The generator is working with the hydrochloric acid – chlorite process and uses the diluted chemicals hydrochloric acid (HCl 9%) and sodium chlorite (NaClO₂ 7.5%) in accordance to the following chemical equation:

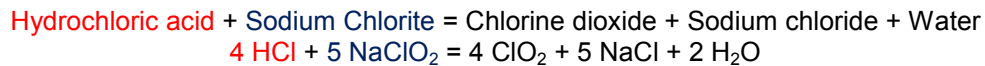

In the process each chemical is pumped with a specific proportion into a reactor vessel [23] by two dosing pumps [5 and 6]. Each stroke from each pump is triggered by the LOTUS-controller [8] and counter-controlled by a “SEFL” [25 and 28].

Inside the reactor vessel the chemicals are reacting to chlorine dioxide with a concentration of 2% (= 20 g/l).

The finished chlorine dioxide leaves the reactor vessel through a back pressure valve [21] on the top of the reactor and a injection valve [20] into a bypass line for an advanced dilution with water.

The advantages are:

- The chlorine dioxide can be pumped direct into pressurized systems with the pressure of the pumps and likewise into pressure-less storing tanks, to distribute the disinfection liquid to different points of use.
- The System can work in proportional mode with contact water meter, current signal or chlorine dioxide measurement.

3.2 System overview

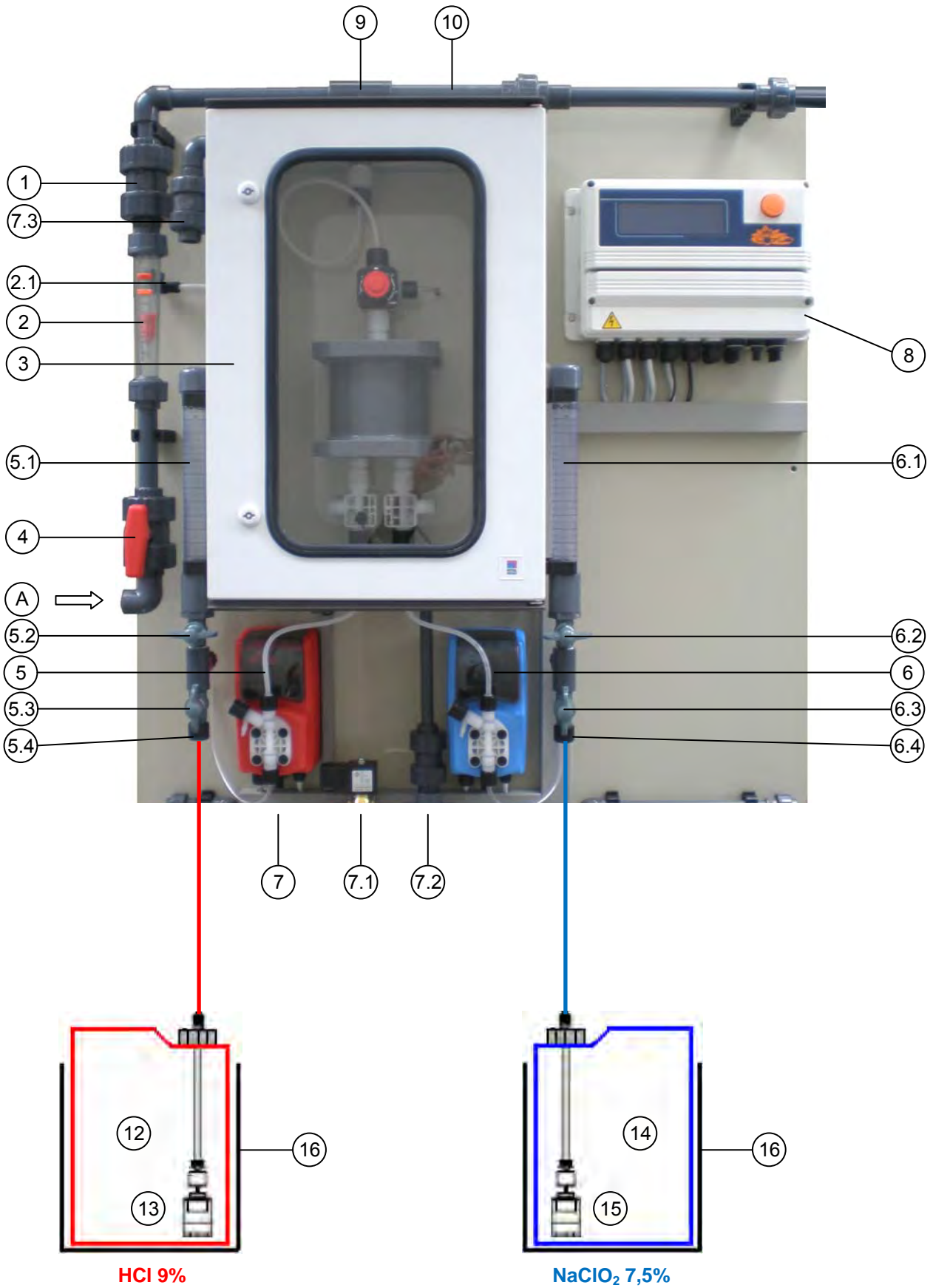

- | | | | |
|-----|-----------------------------------|----|---|
| 1 | Check valve | | |
| 2 | Flow meter with floater | | |
| 2.1 | Switching contact | | |
| 3 | Reactor housing | | |
| 4 | Ball valve | 8 | LOTUS controller |
| 5 | Acid dosing pump | 9 | Reactor outlet valve |
| 5.1 | Calibration cylinder | 10 | Static mixer |
| 5.2 | Ball valve | | |
| 5.3 | Ball valve | | |
| 5.4 | Hose connection for suction lance | | |
| 6 | Chlorite dosing pump | 12 | Tank with hydrochloric acid 9 % |
| 6.1 | Calibration cylinder | 13 | Suction lance with level-switch „Hydrochloric acid“ |
| 6.2 | Ball valve | 14 | Tank with sodium chlorite 7.5 % |
| 6.3 | Ball valve | 11 | Level switch „Dilution water tank empty“ |
| 6.4 | Hose connection for suction lance | 15 | Suction lance with level-switch „Sodium chlorite“ |

- A Pipe connection for bypass line DN 20, PVC socket 25 mm
 C Drain

3.3 Reactor overview

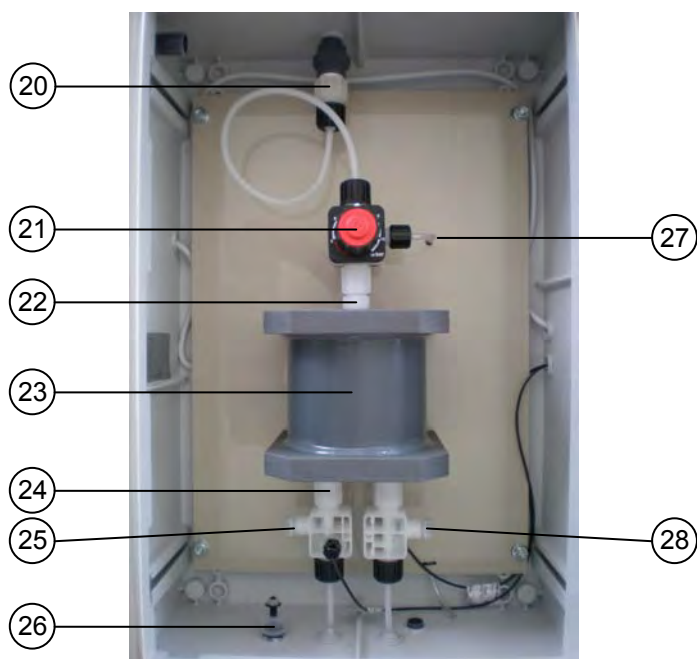

- | | | | |
|----|----------------------------|----|------------------------------|
| 20 | Injection valve | 25 | SEFL Acid dosing control |
| 21 | MFKT Multi function valve | 26 | Level switch |
| 22 | Check valve 0.3 bar | 27 | Over-pressure drain tube |
| 23 | Reactor | 28 | SEFL Chlorite dosing control |
| 24 | Check valve 5 bar (qty. 2) | | |

4. Installation

Safety information:



Warning!

- For the operation of the LOTUS generator the absolute observance of the national and local regulations is required. The operator is liable for the observance of the local safety instructions.
- The generator must be installed and started up in accordance to the regulations in this manual.
- The usage of installation parts not approved by the manufacturer or supplier is prohibited.
- The operation of the generator is allowed only with suitable safety-valves approved by the manufacturer. The contempt of this regulation results the ultimate loss of any warranty claims!
- Before starting works at the plant decompress all parts of the system.
- The plant never has to work against closed valves because of the risk of bursting hoses or pipes.
- Disconnect the power supply before opening the controller housing.
- Take care of all national regulations during installation!

4.1 General requirements for the installation site



Notice:

- The plant must not be placed outdoors.
- The plant must be protected against unauthorized access.
- The site must be protected against sunlight and frost and well ventilated.
- For temperatures less than 10° C a suitable tempering system for the site is required.
- It must be possible to transport the chemical containers to the plant without any obstructions.
- An emergency exit route is stringent required!
- The plant must be mounted onto a vertical solid wall without tensions.
- The plant must be mounted in a way that no vibrations can be produced.
- Take care of free entrance from all sides for the operation and maintenance!
- Tap water and a lockable floor gully should be present for the risk-free removal of spilled chemicals.
- A fuse-protected power-supply with an emergency stop-switch outside the installation room is required.

4.2 General requirements for the plant installation



Notice:

- The LCD screen of the control can be easily read.
- The liquid level of the full chemical containers is below the dosing pumps.
- The maximum priming lift of the dosing pumps is not exceeded, see table "Technical data" in the appendix.
- As necessary, there is still sufficient space for the chemical containers below the panel.

4.3 Requirements for the water

Safety information:



Warning!

Serious malfunctions at the plant or corrosion damages in the pipe-work of the treated water should be possible in case the following requirements to the water – the chlorine dioxide is produced for – as well as for the dilution water are not fulfilled:

Temperature: 10 – 30° C

Pressure: 0.3 - 8 bar

Quality: Free of iron, manganese and particles, non-corrosive.

The following directions are based on a concentration for chlorine dioxide of 0.4 mg/l to prevent pipe-corrosion:

- The pH-level should be always higher than pH 6.5.
It should be controlled during operation.
- In case the carbonate hardness is lower 1.1° dH (German hardness) or the alkalinity is lower 0.4 mMol/l the dosing of suitable chemicals for the increase of the pH-level is required.

4.4 Assembling

- The plant must be mounted onto a vertical solid wall without tensions.
- The plant must be mounted in a way that no vibrations can be produced.
- The location should be nearby the chlorine dioxide injection point.
- Take care of free entrance from all sides for the operation and maintenance!
- The plant-bottom should be minimum 1 m over the floor-level.
- The level of the complete filled chemical tanks must always be under the level of the dosing pumps.
- The maximum suction-height for the dosing pumps should be not more than 2 meters.
- Fix the plant with the six mounting-holes of the panel to the wall.



Notice:

For a safety fastening hanger bolts M8 x 60 mm are suggested.

4.5 Hydraulic Installation

Safety information:



Warning!

Warning against illegal operation

Observe the regulations about the plant location.



Danger!

Warning of toxic chlorine dioxide vapour

Toxic chlorine dioxide vapour can escape because of a broken bypass line.

- Use only PVC or PVDF pipes for the bypass line.
- Use only PVC pipes of pressure rating PN 16 for the bypass line.
- The maximum permissible system operating pressure must not be exceeded – see "Safety equipment bypass line" – "PVC bypass line specifications").
- Pressure surges must be avoided.



Warning!

The reactor can explode

In case of an uncontrolled sucking of the chemicals into the reactor, caused by a vacuum in the bypass-line and a simultaneous formation of gas/water mixed phases, chlorine dioxide can gas out. Under adverse circumstances, the critical gas concentration of 300 g/m³ is exceeded and an explosion of the reactor can occur.

Take appropriate measures to ensure that the bypass line of the LOTUS system does not become subject to a vacuum.

Main components:

Basically the following hydraulic components must be installed:

- Bypass line
- Safety equipment of bypass line (optional)
- Additional safety fittings (optional)
- Point of injection (optional)
- Hydraulic module "water supply" (optional)
- Flushing equipment with vacuum relief valve (optional)
- Suction lances / suction assemblies acid and chlorite
- Water supply suction mechanism (optional)

4.5.1 Installation example A

- Point of injection (34) direct in the main water supply.
- Operation mode: "Proportional"

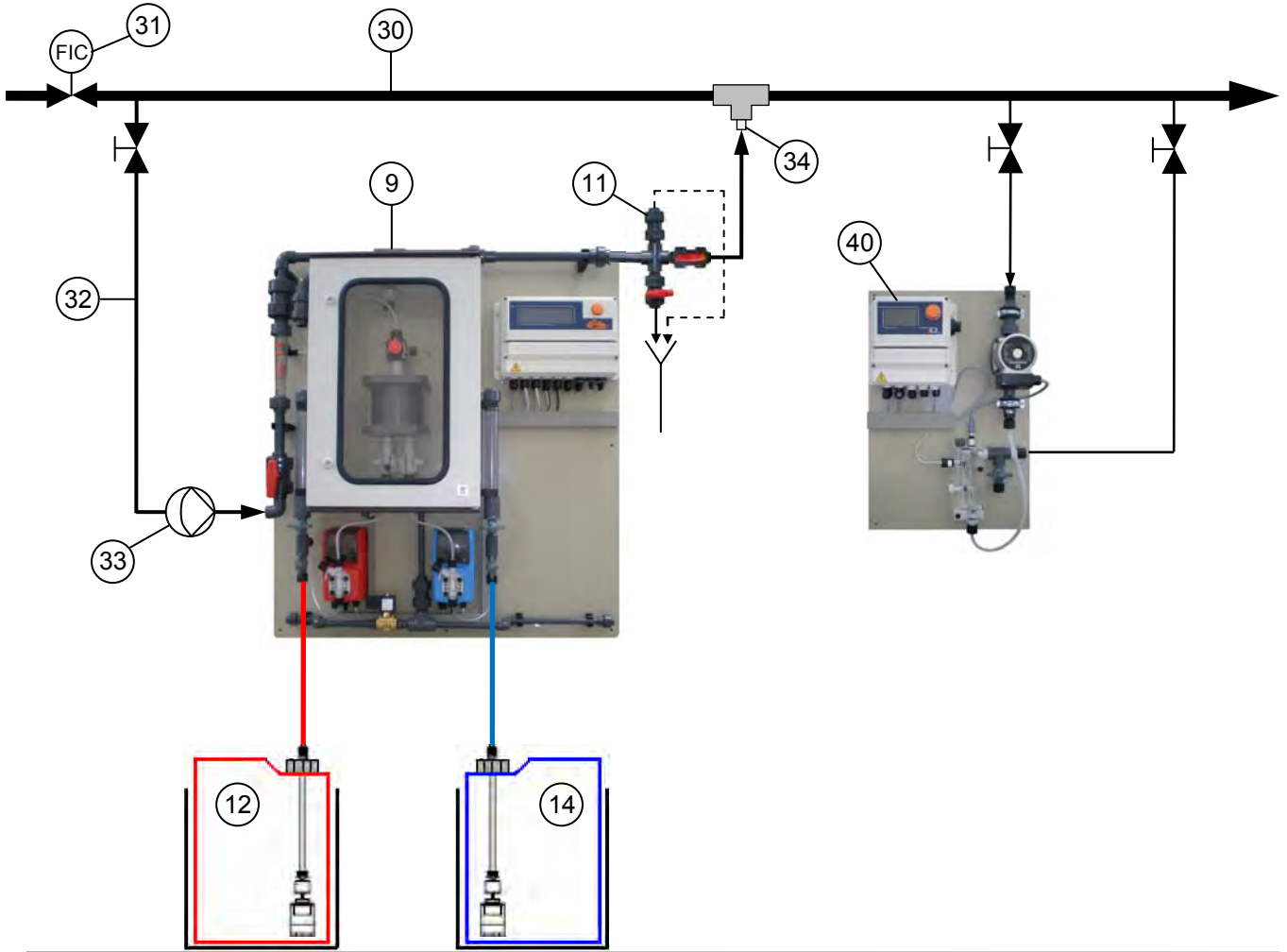

- | | | | |
|----|---|----|--|
| 9 | Reactor outlet valve | 30 | Main water supply |
| 11 | Flushing unit with vacuum relieve valve | 31 | Water meter (frequency or analog signal) |
| 12 | Acid tank in safety tub | 32 | Bypass line |
| 14 | Chlorite tank in safety tub | 33 | Bypass pump |
| | | 34 | Point of Injection (immersion pipe) |

4.5.2 Installation example B

- The reactor outlet valve (9) of the LOTUS system is located beneath the point of injection (34).
- Operation mode: "Proportional"

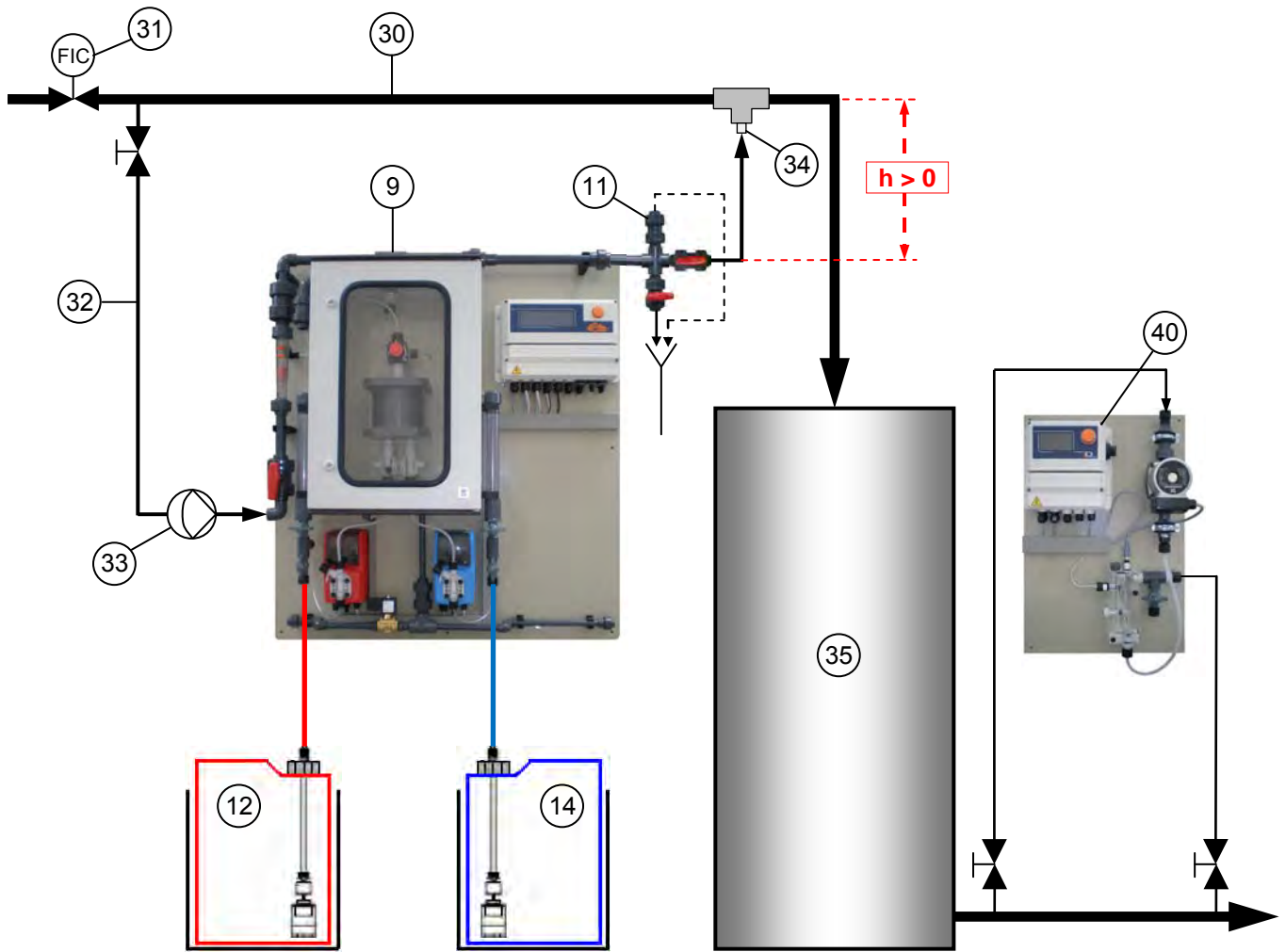

- | | | | |
|----|---|----|--|
| 9 | Reactor outlet valve | 30 | Main water supply |
| 11 | Flushing unit with vacuum relieve valve | 31 | Water meter (frequency or analog signal) |
| 12 | Acid tank in safety tub | 32 | Bypass line |
| 14 | Chlorite tank in safety tub | 33 | Bypass pump |
| | | 34 | Point of Injection (immersion pipe) |
| | | 35 | Delay tank |
| | | 40 | ClO ₂ – Measuring unit type PA-LDCLO ₂ +CP |

4.5.3 Installation example C

- The reactor outlet valve (9) of the LOTUS system is located beneath the point of injection (34).
- Operation mode: "Proportional"

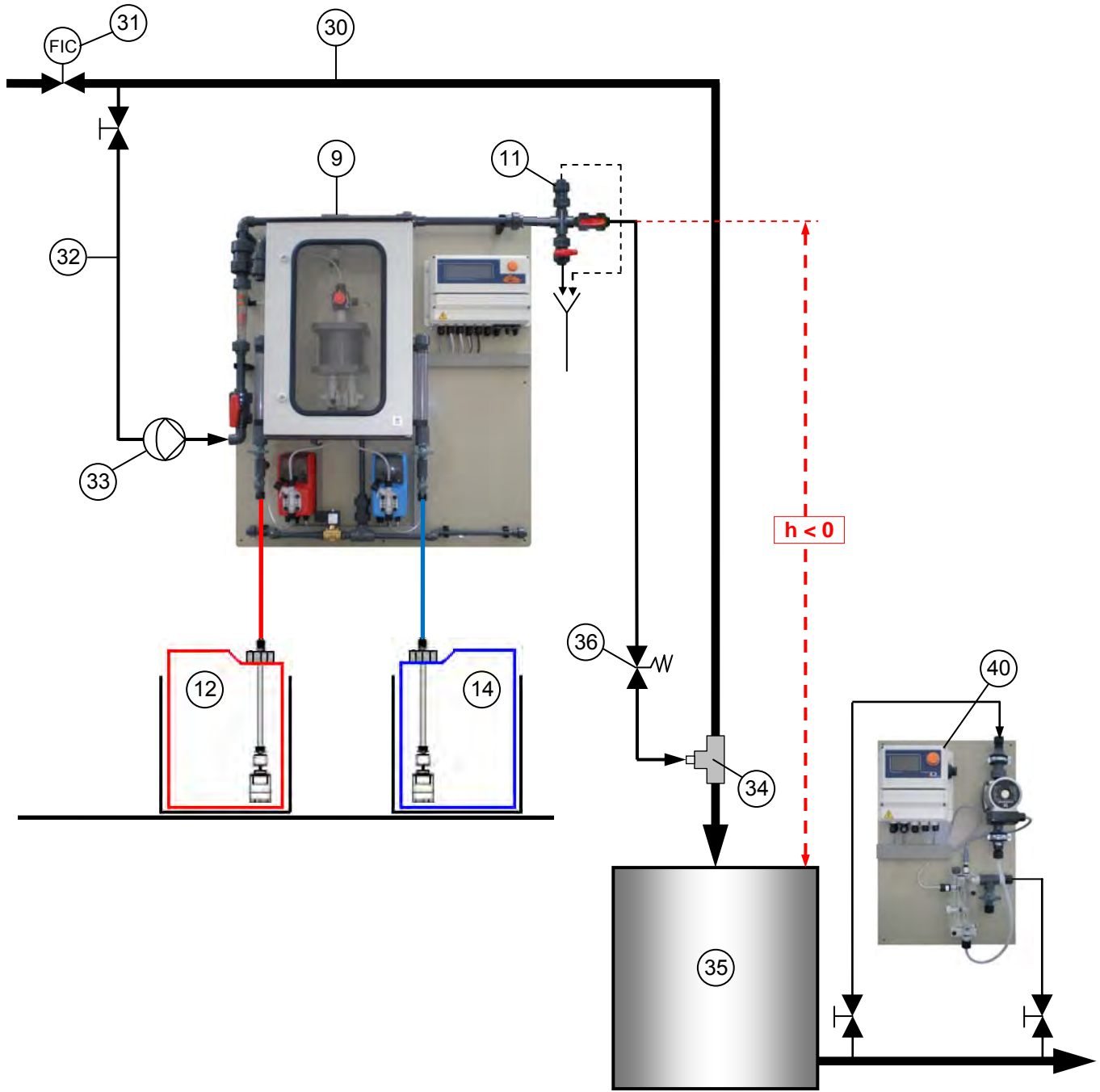

- | | | | |
|----|---|----|--|
| 9 | Reactor outlet valve | 30 | Main water supply |
| 11 | Flushing unit with vacuum relieve valve | 31 | Water meter (frequency or analog signal) |
| 12 | Acid tank in safety tub | 32 | Bypass line |
| 14 | Chlorite tank in safety tub | 33 | Bypass pump |
| | | 34 | Point of Injection (immersion pipe) |
| | | 35 | Delay tank |
| | | 36 | Back pressure valve |
| | | 40 | CIO ₂ – Measuring unit type PA-LDCLO ₂ +CP |

4.5.4 Installation example D

- Batch tank filling with water supply module
- Operation mode: "Batch"

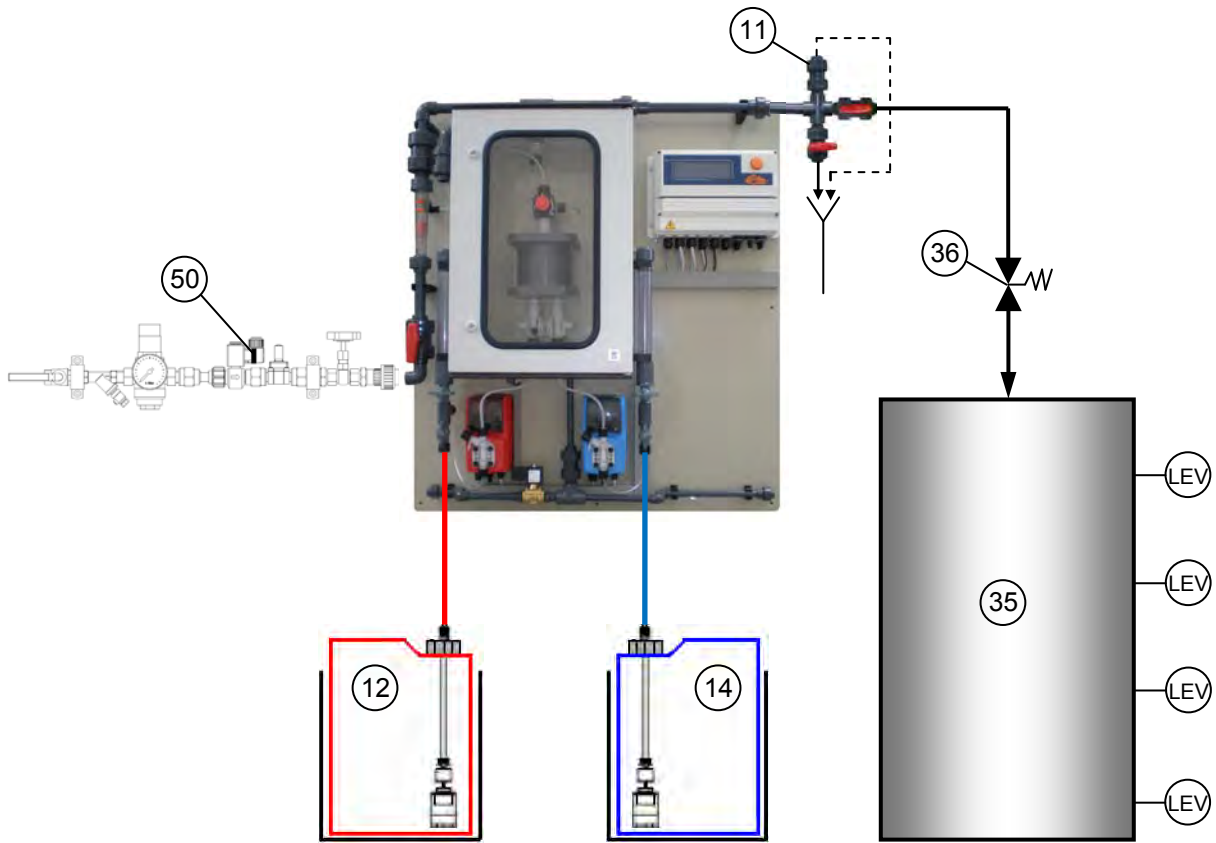

- | | | | |
|----|---|----|-----------------------|
| 11 | Flushing unit with vacuum relieve valve | 35 | Batch tank |
| 12 | Acid tank in safety tub | 36 | Back pressure valve |
| 14 | Chlorite tank in safety tub | 50 | Module "Water Supply" |

4.6 Hydraulic Installation of accessories and options

4.6.1 Bypass line

Safety information:



Danger!

Warning of toxic chlorine dioxide vapour

Toxic chlorine dioxide vapour can escape because of a broken or leaking bypass line.

- Use only PVC or PVDF pipes for the bypass line.
- Use only PVC pipes of pressure rating PN 16 for the bypass line.
- The maximum permissible system operating pressure must not be exceeded – see "Safety equipment bypass line" – "PVC bypass line specifications").
- Pressure surges must be avoided.



Warning!

The reactor can explode

- In case of an uncontrolled sucking of the chemicals into the reactor, caused by a vacuum in the bypass-line and a simultaneous formation of gas/water mixed phases, chlorine dioxide can gas out. Under adverse circumstances, the critical gas concentration of 300 g/m³ is exceeded and an explosion of the reactor can occur.

Take appropriate measures to ensure that the bypass line of the LOTUS system does not become subject to a vacuum.

- Particles in the bypass water could block the flow meter. This can lead to an unacceptably high concentration of chlorine dioxide. If a bypass line is not completely full with water, a critical gas phase can form, resulting in an explosion in the bypass line.
Install a dirt-trap filter in the bypass line, if required.

Function:

The bypass line (32) is either fed from the main water supply (30) or separately. The purpose of the bypass line is to dilute the chlorine dioxide concentration of the chlorine dioxide solution from the reactor from approximately 20 g/l (= 20,000 ppm) to approximately 0.1 - 1 g/l (= 100 - 1000 ppm) and to transport this solution to the point of injection (34).

4.6.2 Safety equipment bypass line

Safety information:



Warning!

The reactor can explode

If the chlorine dioxide solution in the reactor becomes subject to a vacuum, it can explode.

Hence the bypass line should be installed so that it is impossible for a vacuum to arise, not even when the plant is stand-by or in the case of a fault.

Risk of explosion in the bypass line

If the dosing remains switched on when there is no water flow, it can lead to an unacceptably high concentration of chlorine dioxide in the bypass line. If in addition, the bypass line is not completely full with water, a critical gas phase can occur, resulting in an explosion in the bypass line.

Function:

In LOTUS systems with bypass monitoring, the LOTUS controller switches the dosing off, when the minimum contact (2.1) at the flow meter [2] is set correctly.

Safety information:



Warning!

Degassing ClO₂ solution can still vaporize in the bypass line.

If the vacuum relief valve (11.2) becomes blocked due to dirt, it cannot prevent degassing of the ClO₂ solution in case of vacuum in the bypass line. If dirt can enter the vacuum relief valve (11.2) from above, protect it with a suitable cover.



Danger!

Poisonous ClO₂ solution can escape

Protect the rinse valve (11.1) against unintentional opening, e.g. using a cable tie or a padlock.

4.6.4 Back pressure valve

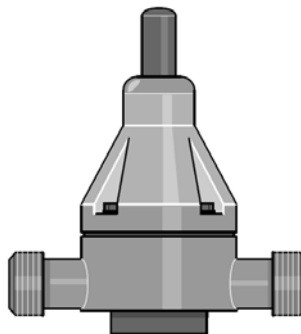

Function:

A back pressure valve (36) placed at the end of the bypass line – with a opening pressure > 1.5 bar – shortly before the point of injection (34). Use the back pressure effect-free design to maintain a operation even at high back pressures!

4.6.5 Flow generator for bypass line

Function:

To create a flow in the bypass line, two alternatives are recommended:

- A choke valve in the main water supply line, e.g. gate, spring or weight-loaded non-return valve.
- A bypass water pump (33) in the bypass line prior to the LOTUS system. The bypass pump can be locked via the LOTUS controller. When installing a bypass pump, the installation of a Y-type valve for the flow-adjustment is recommended.

4.6.8 Suction lances

Safety information:



Danger!

Warning of toxic chlorine dioxide gas

Toxic chlorine dioxide gas can arise outside the reactor.
Allocate parts correctly to the acid and chlorite sides.



Warning!

Warning of corrosive acid or toxic chlorite solution

Corrosive acid or toxic chlorite can escape at the connections.
Only use suitable hoses and connector kits.

Assembly:

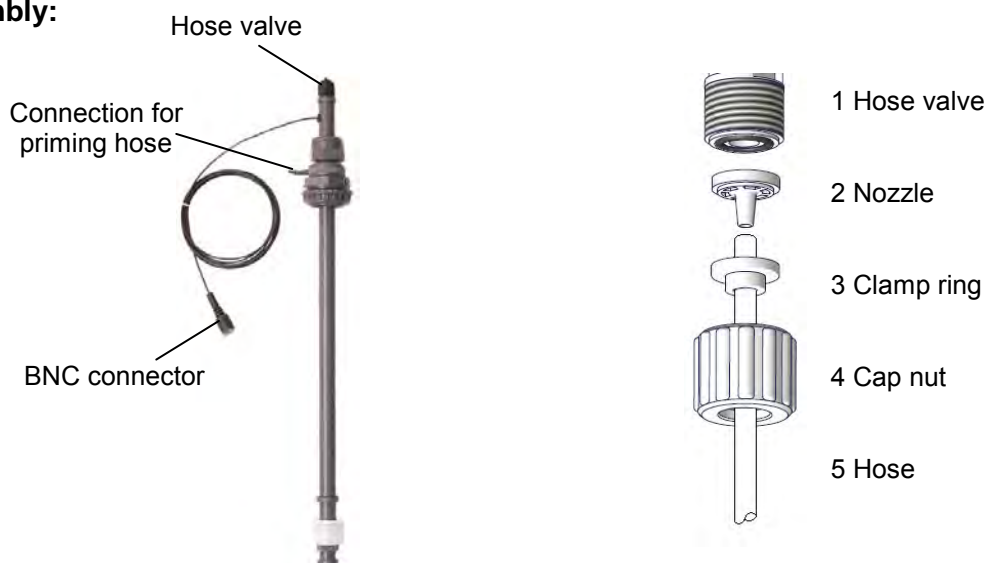

Caution!

The suction hoses must not be plugged into the chemical tanks yet!

First connect the suction hoses to the suction lances:

1. Pull the cap nut (4) and clamp ring (3) over the suction hose (5)
2. Push in the hose end up to the stop over the nozzle (2)
(it may be necessary to slightly widen the hose end).
3. Fit the nozzle on the hose valve of the suction lance (1).
4. Press the suction hose (5) on to the nozzle (2) and tighten the cap nut (4).
5. Adjust the length of each suction lance - the foot valve must subsequently float in the container just above the floor.
6. Shorten the suction hoses so that they rise continuously and free from tension.
7. Repeat step 1 – 4 to fit the free ends of the suction hoses to the hose connections (5.4 and 6.4).
8. Connect the priming valves of the dosing pumps to the priming hose nipple of the suction lances with a PVC hose (included in the scope of delivery).
9. At least connect the BNC connectors for the suction lance level-switch to the suitable connection socket at the LOTUS controller.



Caution!

The suction lances have colored screw-caps: Red for acid and blue for chlorite.
Don't alternate the connections!

4.7 Electrical Installation



Caution!

- Installation only made from an authorized expert!
- In Germany: Take the instructions of VDE 0165 into consideration. In foreign countries: Consider the current national regulations!
- Risk of electric shock!
- Take care that the power supply meets the power requirements of LOTUS (see plant-label).
- Disconnect power supply before opening the controller housing!

Basically the electrical installation involves the following work:

- Installation of the main power supply
- Installation of the emergency stop switch at the room entrance
- Connection of the bypass pump
- Connection of the gas detector (if required)
- Connection of the level switches from the suction lances

4.7.1 Power supply

LOTUS has a standard cable with CE-connector. For the power supply a fail-saved humid room damp proved electric socket is required.



Caution!

- The electric socket has to be placed nearby LOTUS for easy disconnection in case of emergency stop or maintenance.
- The electric socket must be placed free for easy access from all sides.
- A suitable overload protection for the power supply is stringent required!

4.7.2 Installation of an emergency stop switch



Warning!

After particular incorrect operations or faults, it can be dangerous to approach to the system. Then you must at least switch the system off using an emergency stop switch, which is located at a safe distance.

- Install an emergency stop switch in the mains supply cable.
- The emergency stop switch must be installed in an easily accessible, invulnerable position in the vicinity of the door of the installation room of the chlorine dioxide system and must be suitable labeled.
- The emergency stop switch must disconnect the electrical supply equipment connected to the system from the mains.

4.7.3 Connection of the bypass pump



Caution!

For a bypass pump with a power rating up to the limit rating (230 VAC, 1.1 A), the LOTUS controller can supply the mains voltage. Consequently the bypass pump is simultaneously locked with the chlorine dioxide generator.

For bypass pumps with electrical ratings greater than the limit rating, use a contactor relay.

For the connection to the LOTUS controller see the wiring diagram in chapter "LOTUS terminal board"

4.7.4 Installation of a gas detector (accessory)



Notice:

To increase the safety, it is a chlorine dioxide gas detector is strongly recommended. Connect the device to the LOTUS controller in accordance with the wiring diagram in chapter "LOTUS terminal board"

As soon as the gas detector senses chlorine dioxide, it switches the system off and the LOTUS controller generates an alarm.

4.8 Placing of warning labels

In case there are no other special national regulations or directives, place the following symbols and labels beside the entrance of the plant operation room:



Danger!

Toxic substances

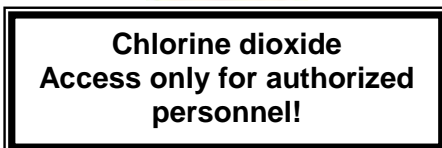

Prohibition!

No Fire, naked light and smoking

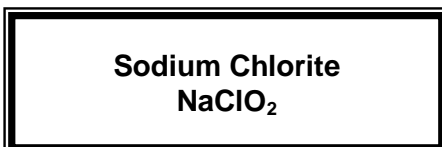





Disposal of end-of-life equipment by users

This symbol warns you not to dispose of the product with normal waste. Respect human health and the environment by giving the discarded equipment to a designated collection center for the recycling of electronic and electrical equipment. For more information visit the online site.



When dismantling a pump please separate material types and send them according to local recycling disposal requirements. We appreciate your efforts in supporting your local Recycle Environmental Program. Working together we'll form an active union to assure the world's invaluable resources are conserved.