



This manual contains safety information that if ignored can endanger life or result in serious injury. They are indicated by this icon.



Keep the instrument protected from sun and water. Avoid water splashes.



OPERATING INSTRUCTIONS FOR "WDPHOS" "WDPHOS PER" INSTRUMENT

ERMES COMMUNICATION
www.ermes-server.com

Read Carefully !



ENGLISH Version

R3-01-13



NORME CE
EC RULES(STANDARD EC)
NORMAS DE LA CE

Direttiva Basso Voltaggio
Low Voltage Directive
Directiva de baja tensión } **2006/95/CE**

Direttiva EMC Compatibilità Elettromagnetica
EMC electromagnetic compatibility directive
EMC directiva de compatibilidad electromagnética



GENERAL SAFETY GUIDELINES

Danger!

In emergencies the pump should be switched off immediately! Disconnect the power cable from the power supply!

When using pump with aggressive chemicals observe the regulations concerning the transport and storage of aggressive fluids!

When installing always observe national regulations!

Manufacturer is not liable for any unauthorized use or misuse of this product that may cause injury, damage to persons or materials.

Caution!

Pump must be accessible at all times for both operating and servicing. Access must not be obstructed in any way!

Feeder should be interlocked with a no-flow protection device.

Pump and accessories must be serviced and repaired by qualified and authorized personnel only!

Always discharge the liquid end before servicing the pump!

Empty and rinse the liquid end before work on a pump which has been used with hazardous or unknown chemicals!

Always read chemical safety datasheet!

Always wear protective clothing when handling hazardous or unknown chemicals!

1. Introduction

WDPHOS is a fully Integrated All-in-One Swimming Pool Controller. Ideal for new construction projects the WDPHOS innovates panel mount capability into a small wall-mount package. 2 Pumps for pH adjustment and Active Oxygen dosing in PVDF, small-form-factor saves space, installation time, and shipping expense. It includes Input for a Flow Switch. Integral pumps can handle up to 20 bar and 16 l/h (Self-Venting Liquid-end as option), high maintenance tubing sets and roller assemblies.

Working ranges is: pH : from 0 to 14pH

Please note about background color display (RGB Version only):

GREEN: normal working mode | **WHITE :** Standby | **RED:** Alarm (che info status)

YELLOW: Warning (check controller, ie.: delay time active)

All information are provided through a large LCD display. Using a revolutionary wheel control the instrument can be easily programmed. WDPHOS is housed in a IP65 plastic box.

2. The wheel

Located in the upper right side of WDPHOS there is a wheel that must be used to control the instrument. Wheel can be rotated in both directions to scroll over the menus and / or pressed to confirm highlighted selection / value.

NOTE: Once changes are made press "OK" to save and exit from submenu. Press "ESC" to exit without saving.



Rotate wheel to scroll through menus or options

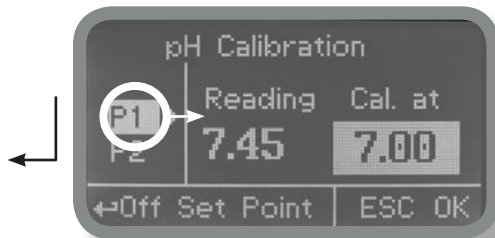

Press wheel to select highlighted option

3. Mainboard Connections

Unplug instrument from main power supply then perform connections to probes and / or selected outputs by following the above picture.

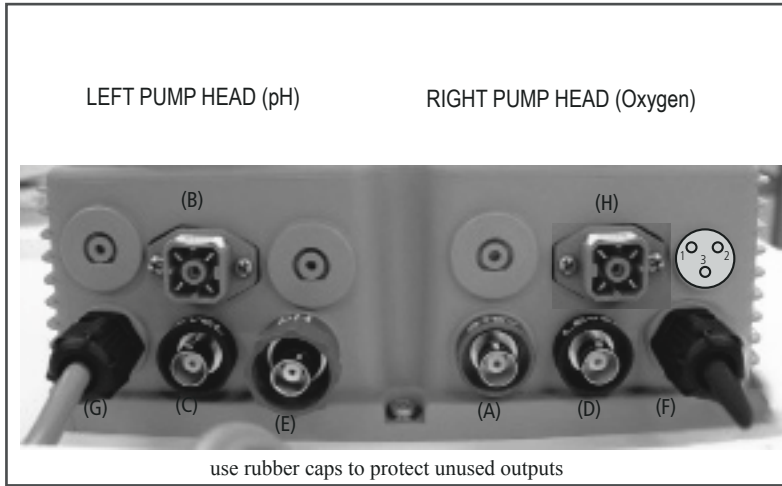

(A) STAND-BY input

(B) Flow input:



- 1 Blue (Ground)
- 2 Brown (+)
- 3 n/a
- 4 Black (Signal)

(C) pH Level input (left pump head)

(D) Oxygen Level input (right pump head)

(E) pH EPHS probe connector

(F) Alarm Contact (Red / Black)**

(G) Power Supply: 230VAC 50/60 Hz

(H) Temperature Probe PT100*:



- 1 Green
- 2 Brown
- 3 White
- 4 Yellow

(L) RS485 communication only

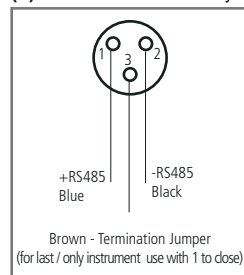

*remove, if previously installed, resistance

** *freecontact max load 4A 250V (active when flow alarm, level, dosing problem and broken probe)

Warning: Connections must be performed by qualified and trained personnel only.

3.1 Hydraulic connections, hoses

Unplug instrument from main power supply then perform connections to probes and / or selected outputs by following the above picture. Hydraulic connections are:

- Suction Hose with level probe and foot filter
- Delivery Hose with injection valve
- Discharge Hose

Suction Hose.

Completely unscrew tightening nut from pump's head and remove assembling components: tightening nut, holding ring and pipe holder.

Assembly as shown. Insert hose into pipe holder until it reaches the bottom.

Lock hose on pump's head by screwing down the tightening nut.
Use only hands to do it!

Connect other side of the hose to the foot filter using the same procedure.

Delivery Hose.

Completely unscrew tightening nut from pump's head and remove assembling components: tightening nut, holding ring and pipe holder.

Assembly as shown. Insert hose into pipe holder until it reaches the bottom.

Lock hose on pump's head by screwing down the tightening nut.
Use only hands to do it!

Connect other side of the hose to the injection valve using the same procedure.

Discharge hose.

Insert one side of discharge hose into pump head discharge connector.

Insert other side of discharge hose into product's tank.
During priming procedure product exceeding will flow into tank.



3.2 Hydraulic connections, level probes

Assembling foot filter with level probe. Level probe must be assembled with foot filter using the provided kit. Foot valve is made to be installed into tank's bottom without sediments priming problem.

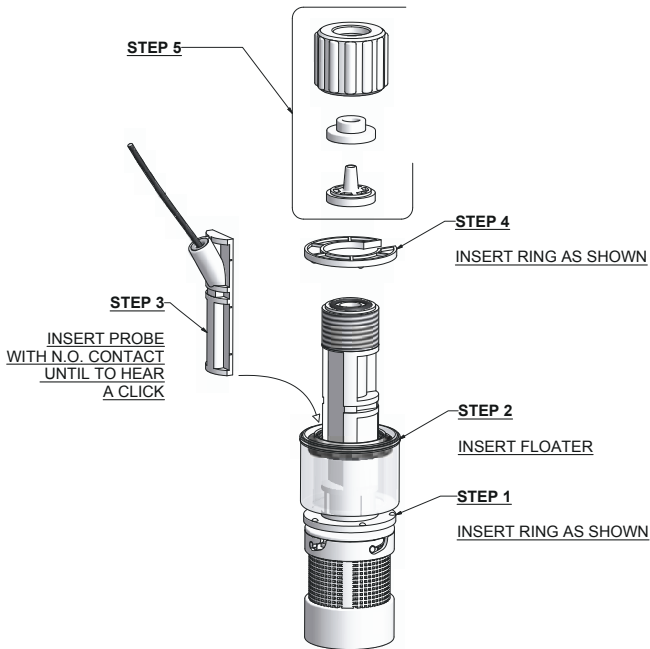

Connect BNC from level probe into WDPHOS level inputs ("B" and "E" connectors).

Put level probe assembled with foot filter into tank's bottom.

Warning: If there is a mixer installed into tank, install a suction lance instead of level probe / foot filter.

3.2.1 WDPHOS PER Version (Flow: 2,2 l / h)

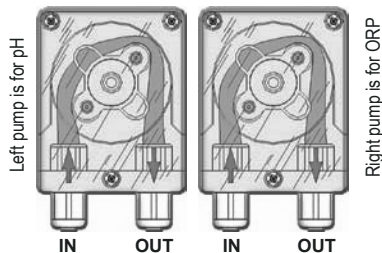

3.3 Hydraulic connections, pump heads

Injection Valve.

Injection valve must be installed on plant from water's input.

Injection valve will open at pressure greater than 0,3bar.

Feeder should be interlocked with a no-flow protection device to automatically shut-off the pumps when there is no flow!

Adequate measures shall be taken to prevent cross connection of chemicals!

Chemical feeding must be stopped during backwash cycles and periods of noflow as these conditions may introduce the potential for chemical overdosing. Not doing so may result in elevated chemical concentrations and hazardous gas introduction into the pool or spa.

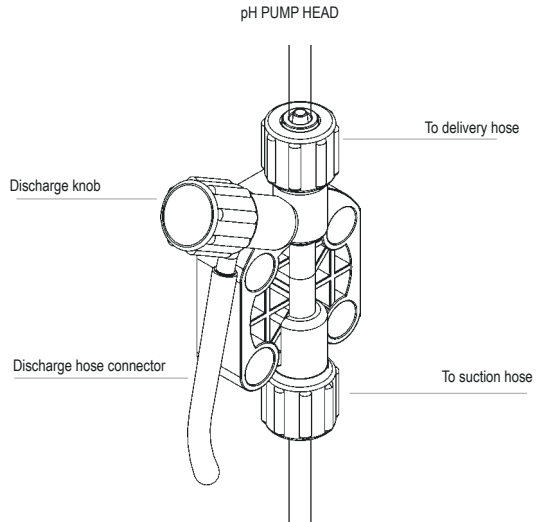

Self-venting pump head

Self-venting pump head must be used when using chemicals that produce gas (i.e. hydrogen peroxide, ammonium, sodium hypochlorite at particular conditions).

Hoses assembling procedure (including purge hose) is described in fig. (A).

Notes:

- suction, delivery and purge valves are DIFFERENT! Do not exchange them!
- delivery and purge hoses are made of same material!
- it's allowed to lightly bend discharge hose!
- during calibration procedure ("TEST") insert discharge hose into BECKER test-tube!

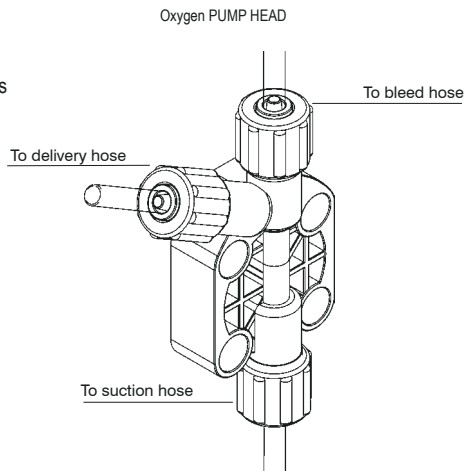

4. Main Screen

When into normal operating mode, WDPHOS shows the following main screen:

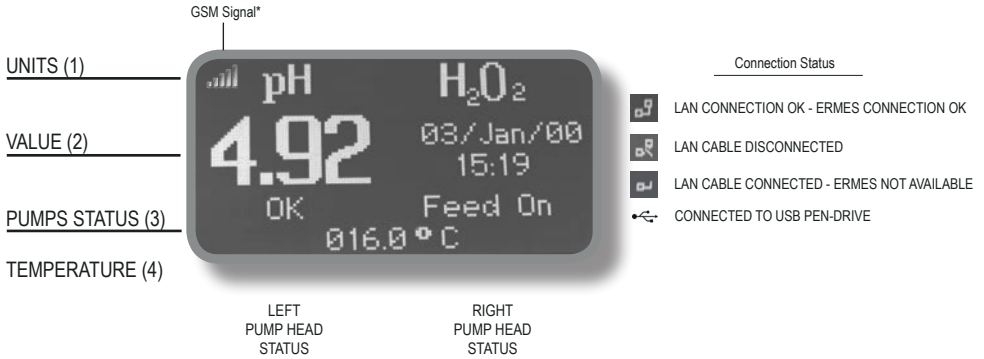

Main screen is divided into 4 zones.

- (1) UNITS. "pH" is the measuring unit for pH probe. "H₂O₂" is for active oxygen.
- (2) VALUES This number is value read by the pH probe.
- (3) PUMPS STATUS These fields are related to current pumps status and instrument activity.
- (4) TEMPERATURE This field shows the current temperature reading

| MESSAGES ON DISPLAY | EXPLANATION | WHAT TO DO IF OCCURS |
|---------------------------|---|--|
| FEED ON | Pump is dosing chemical product. | No action required. |
| FEED OFF | Pump is OFF. | No action required. |
| LOW TANK | Chemical product tank is almost empty. | Check chemical tank. Restore correct level. |
| NO FLOW | External flow contact stops both the pumps. | Check flow. |
| OK | Setpoint reached. | No action required. |
| FEED LIMIT | Time for dosing exceeded. Dosing alarm. | Check pump dosing capacity. |
| PROBE FAIL | Stuck reading values. | Check probe for proper functioning. |
| DELAY | Pump activity delayed. Countdown in progress. | If not requested check PARAMETERS options. |
| POWER SUPPLY OUT OF RANGE | Power supply is out of range. F2 fuse on connection board can be broken. | Check power supply range. Replace F2 fuse (p. 30) |

5. Quick status check

From main screen rotate the wheel to review main instrument parameters and current status conditions.

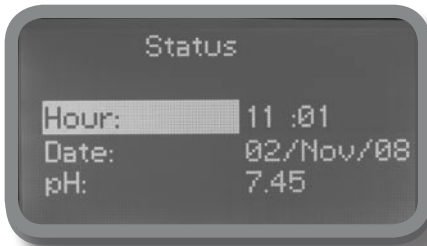

Current time
Today date
Current pH reading



Current pH reading
Current temperature reading
Dosing Alarm
Probe failure status



Flow
Level
Last pH calibration result
Last pH calibration date



Last Temp. calibration result
Last Temp. calibration date

6. Password

To grant access into "Main Menu" press the wheel from main screen and enter the passcode.

If this is the first time here then the passcode is 0000 (factory preset). Press wheel 5 times to enter into "Main Menu".

Otherwise press the wheel 1 time and enter the passcode. Numbers can be selected rotating the wheel.

Note: for advanced configuration menu use "1977" as first-time access password.

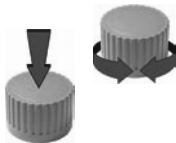
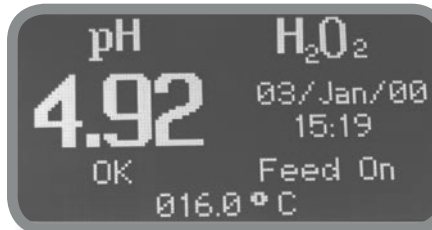

To set a new passcode choose "PARAMETERS" from "Main Menu", move on "New Pcode", click on wheel and enter a four numbers code. Click on "EXIT" and choose "YES" to save request. The new passcode is now ready.

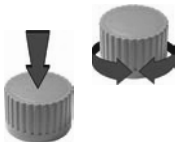

Lost passcode ?

Please don't forget the passcode (if changed). In the unfortunate event, please call your local distributor for unlocking procedure. There is no way for you to recover lost passcode.

7. "Main Menu" list

To grant access into "Main Menu" enter the passcode (as described in previous chapter). Once into "Main Menu" rotate the wheel to scroll through all the options available.

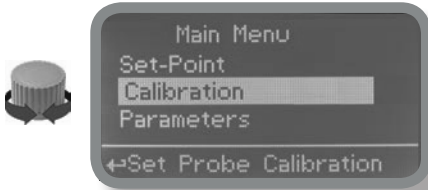

Set-Point (see page 13)
Probe Calibration (see page 16)
Parameters (see page 19)

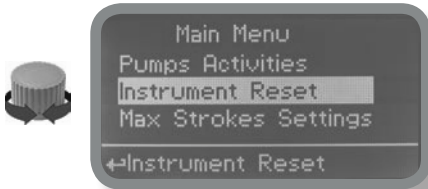

Pumps Activities (see page 21)
Instrument Reset (see page 22)
Max Strokes Settings (see page 22)

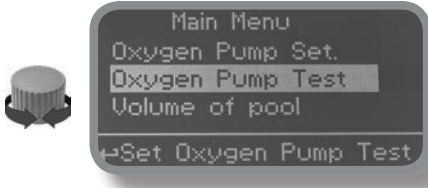

Oxygen Pump Setting (see page 23)
Oxygen Pump Test (see page 24)
Volume of Pool (see page 25)



Dosing Alarm (see page 26)
International (see page 27)
Probe Failure (see page 28)

[continue]

7. "Main Menu" list

To grant access into "Main Menu" enter the passcode (as described in previous chapter). Once into "Main Menu" rotate the wheel to scroll through all the options available.



"Weekly Timer" (see page 28)

"Daily Timer" (see page 29)

"Flow" (see page 30)

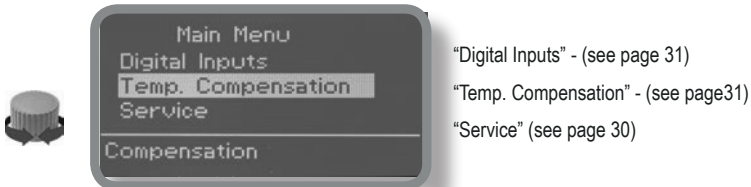

"Digital Inputs" - (see page 31)

"Temp. Compensation" - (see page 31)

"Service" (see page 30)



Log Setup" (see page 32)

"RS485 Setup" (see page 33)

"SMS menu" (see page 33)

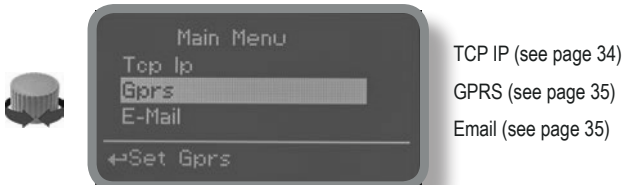

TCP IP (see page 34)

GPRS (see page 35)

Email (see page 35)



Log View (see page 32)

"Exit" - back to main menu

8. "Set-Point", pH (on/off)

pH reading values can be set to operate the pH pump using 2 set-points into **On/Off mode** or **Proportional (%)**.

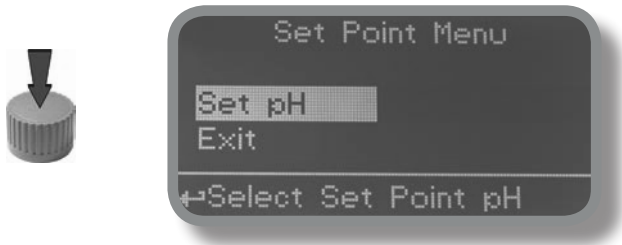

On/Off mode set the instrument to operate using two set values that enable or disable the pH pump. To use this mode move cursor on "Working Mode". Press the wheel and select it.

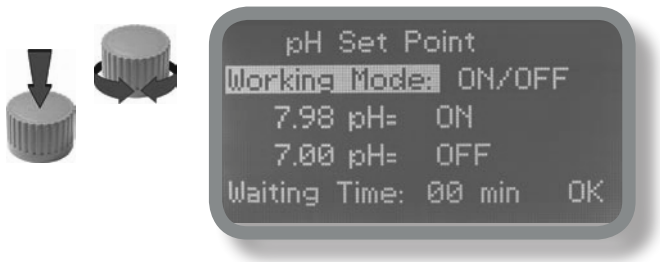

ON/OFF mode while dosing ALKALI

Set pH value at 7.00 OFF and 6.90 ON.

Instrument will leave the pH pump active until reading value will increase up to 7.00pH.

At 7.00pH the pH pump will be disabled until reading value will decrease under 6.90pH.

Waiting Time: to let pump operate at pulses per minutes add one or more minute (1pulse every xx minutes). Otherwise (00 minutes) pump will operate at set stroke settings (see page 22).

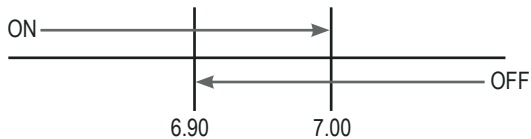

8. "Set-Point", pH (on/off)

ON/OFF mode while dosing ACID

Set pH value at 7.00 OFF and 7.10 ON.

Instrument will leave the pH pump active until reading value will decrease up to 7.00pH

At 7.00pH the pH pump will be disabled until reading value will increase up to 7.10pH.

Waiting Time: to let pump operate at pulses per minutes add one or more minute (1pulse every xx minutes). Otherwise (00 minutes) pump will operate at set stroke settings (see page 22).

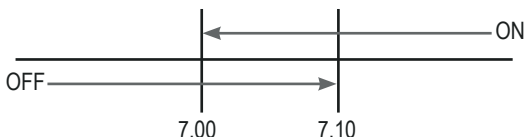

Do you know ?

In chemistry, an alkali is a basic, ionic salt of an alkali metal or alkaline earth metal element. Alkalis are best known for being bases (compounds with pH greater than 7) that dissolve in water. The adjective alkaline is commonly used in English as a synonym for base, especially for soluble bases. This broad use of the term is likely to have come about because alkalis were the first bases known to obey the Arrhenius definition of a base and are still among the more common bases. Since Brønsted-Lowry acid-base theory, the term alkali in chemistry is normally restricted to those salts containing alkali and alkaline earth metal elements.

An acid (often represented by the generic formula HA [H^+A^-]) is traditionally considered any chemical compound that, when dissolved in water, gives a solution with a hydrogen ion activity greater than in pure water, i.e. a pH less than 7.0. That approximates the modern definition of Johannes Nicolaus Brønsted and Martin Lowry, who independently defined an acid as a compound which donates a hydrogen ion (H^+) to another compound (called a base). Common examples include acetic acid (in vinegar) and sulfuric acid (used in car batteries). Acid/base systems are different from redox reactions in that there is no change in oxidation state.

8.1 "Set-Point", pH (proportional)

pH reading values can be set to operate the pH pump using 2 set-points into **On/Off mode** or **Proportional (%)**.



Proportional mode set the instrument to operate using a calculated percentage between two set values that enable or disable the pH pump. To use this mode move cursor on "Working Mode". Press the wheel and select it.

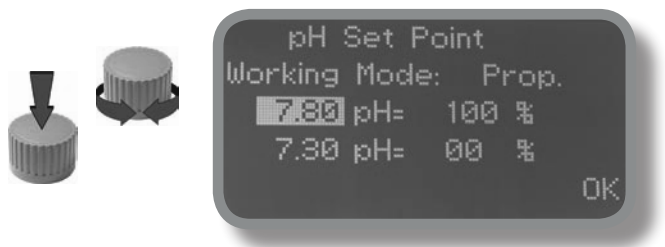

PROPORTIONAL mode between 7pH(0%) and 8pH (100%). [Stroke setting 180]

In this mode the pH pump will be "ON" for values greater than 8pH with maximum set strokes capacity (e.g.: 180) and it'll be "OFF" for values lower than 7pH. For values of 7.5pH pump will be "ON" with 90 strokes capacity. The calculation is based on 180 strokes setting (see page 22).

9. "Probe Calibration", pH

pH calibration procedure involves two calibration points and it requires two buffer solutions. Default buffer solutions are pH 4.00 and pH 7.00. pH reading value can be also 30°C temperature compensated from "pH compensation" menu. From "Menu Calibration" choose "pH probe".



In the following example instrument will calibrate pH using default buffer solutions values.

Note: this procedure assumes that instrument is correctly configured and a working pH probe connected. Otherwise unattended results may occur.

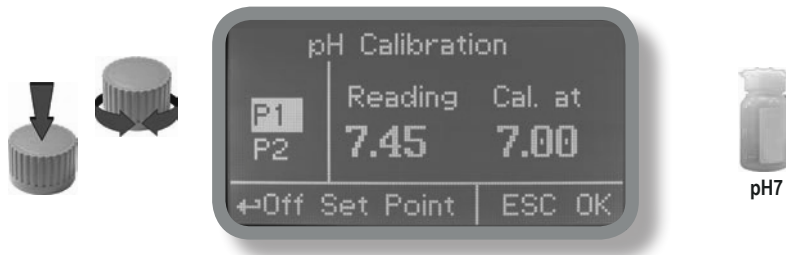

Calib 1st Point.

Once into "pH Calibration" menu move wheel on "P1" then press wheel to enter into first point calibration submenu. Prepare 7.00pH buffer solution and dip probe's sensor on it. Wait until reading value is stable and according to buffer solution value move wheel until it is the same on display ("Cal. at" field). Default value is 7.00pH.

Note: buffer solution value may change if environment temperature it's different than 20°C. Read solution's label for more information. According to this occurrence "pH Default" must be changed.

Power Supply calibration ?

To obtain the most reliable results during pulses calculation is possible to calibrate power supply read value. Press wheel on "P1" then move cursor on "OK" and confirm power supply read value. (e.g.: 230V).

9. "Probe Calibration", pH

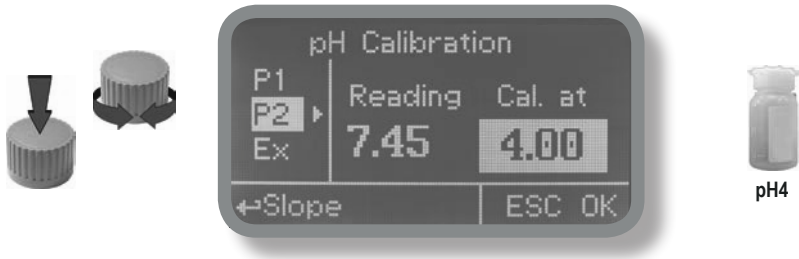

Calib 2nd Point.

Move wheel on "P2" then press wheel to enter into second point calibration submenu. Prepare 4.00pH buffer solution and dip probe's sensor on it. Wait until reading value is stable and according to buffer solution value move wheel until it is the same on display ("Cal. at" field). Default value is 4.00pH.

Note: buffer solution value may change if environment temperature it's different than 20°C. Read solution's label for more information. According to this occurrence "pH Default" must be changed.

9.1 "Probe Calibration", Temperature

Temperature calibration procedure involves probe's selection, 1st Point (P1) calibration. From "Menu Calibration" choose "Temp probe".



Note: This procedure assumes that instrument is correctly configured and a working Temperature probe connected and installed on system. Measurement must be performed using plant water. Otherwise unattended results may occur.

Use a thermometer to measure the plant water temperature quite near to temperature probe connected. According to the value read, move the cursor on P1 and select. Rotate the wheel in the field "Cal. at", press and rotate the wheel until it is the same value.

9.1 "Probe Calibration", Power supply

Not accessible menu.

10. "Parameters"

From "Menu Calibration" choose "Parameters". This menu allows to set a delay (max 60 minutes) before pumps begin to feed. Furthermore use this menu to change default passcode.



Feeding Delay.

Move on "Feeding Delay" then press wheel. Choose a value between 0 (disabled) and 60 minutes (maximum delay time). This feature can be used to accord a startup delay for the pumps. Delay occurs when instrument is powered or after a "NO FLOW" contact recovery.

New Pcode.

See page 10.

11. "Pumps Activity"

From "Menu Calibration" choose "Pumps activity". This menu allows to manually operate one or both the pumps for a settable time.

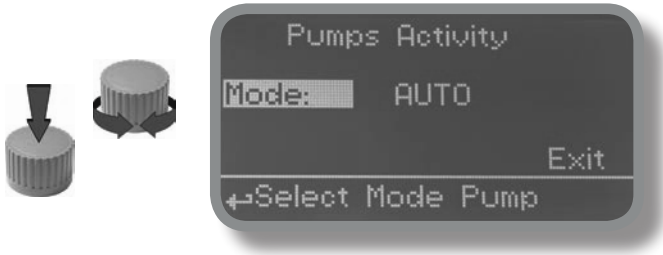

Move on "Mode" then press wheel. Choose:

- "Man. Pump1" for manually operate pH pump;
- "Man. Pump2" for Oxygen pump;
- "Test Pump2" to calculate pump's cc per stroke (see page 22 "Oxygen pump test" for the procedure);
- "AUTO" to automatically operate pumps (set-point based feeding activity);
- "OFF" to switch off the pumps.

If you set "Man. Pump1" or "Man. Pump2", press wheel to move cursor on "TIME" field. Once here, choose a working time between 0 (disabled) or 199 minutes. Move on "EXIT", then press wheel.

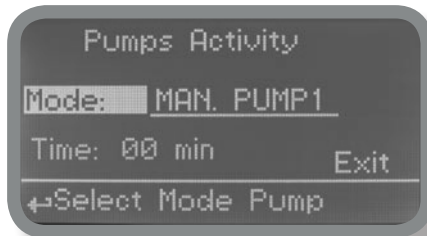

Exit from main menu. Main display will show a countdown including the selected pump (left for pH pump, right for Oxygen pump). To stop this countdown go back to "Pumps activity" menu and choose "ON" as working mode or wait until countdown ends. **This function can be used for priming purposes.**

11. "Instrument Reset"

To restore instrument to its default values (including password) once into "Instrument Reset" menu, press wheel then change value to "ON", press wheel again, move on "OK" then finally press wheel. The instrument display will show "RESET OK". Press wheel to return into "Main Menu". Move on "EXIT", then press wheel. The instrument is now restored to factory default. Please repeat all calibration procedures and programming parameters.



12. "Max strokes settings"

pH pump can be set to operate within a maximum number of strokes. Strokes are the total amount of injections per minute made by a pump. Using wheel choose a value for one or both pumps then move on "EXIT".

To end procedure move cursor on "OK" and press wheel to proceed to "Save" request screen. Move wheel on "YES" to save or "NO" to discard changes.



Note: Pump dosing capacity is based on 180 strokes per minutes

13. "Oxygen pump setting"

This menu set a standard dosing volume at 25°C (77°F) and 30°C (86°F) for Oxygen pump based on swimming pool volume (mc).

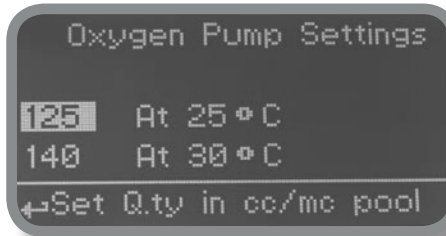

In the field "cc/s" set the result obtained from Oxygen Pump Test (see next menu), then choose a dosing mode between Daily and Weekly. To complete the setting move on Weekly Timer (page 27) or Daily timer (page 28).

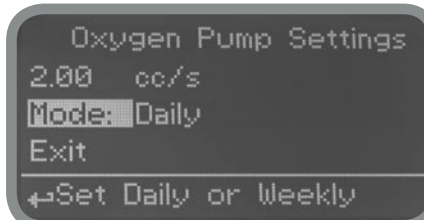

14. "Oxygen pump test"

This procedure defines the cc quantity (cubical centimeters) that the Oxygen pump feed every single injection. To determine this value the pump must be calibrated.

To calibrate the Oxygen Pump cc/s, install the pump on plant and insert the suction hose (with its level probe / foot filter) into a BEKER "test-tube". If pump's model is self-priming put the discharge hose into the "test-tube" too.

Power up the pump and turn the flow's knob to required position.

Fill up the "test-tube" with the chemical until to reach a known value.

From Main Menu, Oxygen Pump Test, set "Test: ON" and the number of pulses then set "Test Pump2" in the "Pump Activity" menu (page 20). Exit from Main Menu and go back to main screen. The pump will begin to produce the pulses set and to suck the chemical from the "test-tube".

At the end of the pulses set the pump will stop. Read the value of chemical left into "test-tube".

Substract the initial value to the left value. Divide the result with the number of pulses set.

Type this value into "CC/ST" as previously described ("Oxygen Pump Setting" menu is available only by entering 1977 as main password).

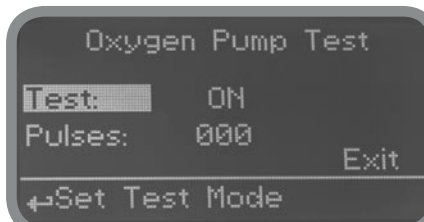

15. "Volume of pool"

Set the swimming pool volume in cubic metres (mc),

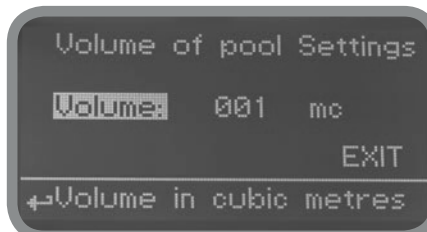

16. "Dosing Alarm"

Use this menu to assign a maximum time to the pH pump for reaching the setpoint. If set time ends and the pump is still dosing, within this menu is possible to STOP it or just to show an alarm message. Function can be disabled selecting "OFF" instead of a number (minutes). Dosing alarm can be set ONLY for pH pump.



E.g. To set pH pump to stop after time ends and setpoint isn't still reached press wheel, choose maximum time, press wheel move on next field and choose "STOP". Time can be set between 100 and 254 minutes. When satisfied with settings move on exit and press wheel.

17. "International"

Use this menu to set international parameters as UNIT FORMAT (Europe IS or USA), Local Time and Date.

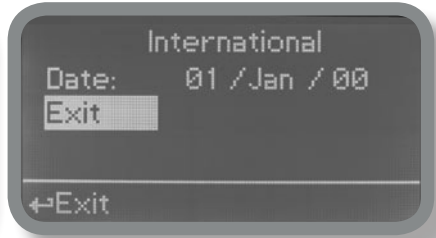
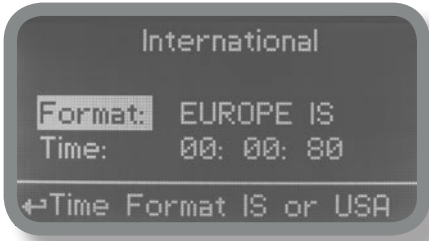

Format.

Use this option to use European or USA units format. See table for differences.

| EUROPE IS (International Standard) | USA |
|------------------------------------|------------------|
| Date (DD/MM/YY) | Date (MMM/DD/YY) |
| Time 24h | Time AM / PM |
| °C | °F |

Time.

Use this option to set local time.

Date.

Use this option to set date.

Move on exit to end changes.

18. "Probe Failure"

Use this menu to assign a maximum time to connected probes to stay stuck. A stuck probe (it remains on same value for some time) means that probably probe itself is damaged. Within this menu is possible to STOP pump or just to show an alarm message (probe failure). Function can be disabled selecting "OFF" instead of a number (minutes). This function can be set only for pH probe.

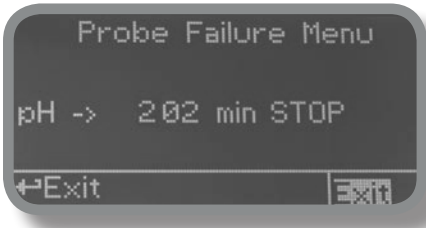
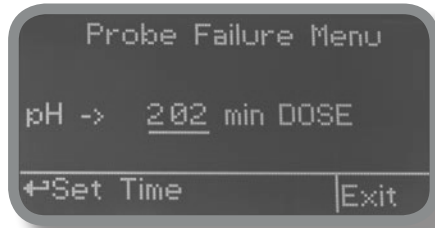

E.g. To set pH pump to stop after time ends and probe doesn't change reading values press wheel, choose maximum time, press wheel move on next field and choose "STOP". Time can be set between 0 and 100 minutes. When satisfied with settings move on exit and press wheel.

19. "Weekly timer"

Use this menu to program a weekly dosing mode: the quantity set in Oxygen Pump Settings menu (on page 22) will be dosed during the week. For every day choose to enable (ON) or disable the Oxygen dosing activity. At the end choose the starting Hour.

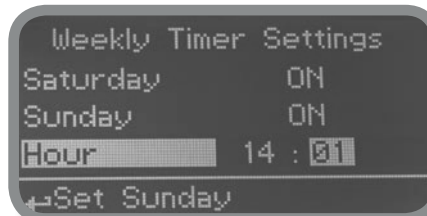
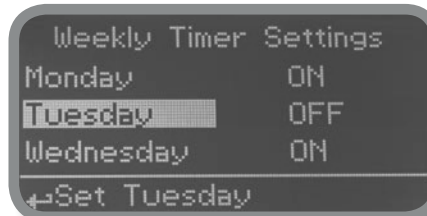

20. "Daily timer"

Use this menu to program a daily dosing mode: the quantity set in Oxygen Pump Settings menu (on page 22) will be dosed during the day (every day).

Timer is the feeding duration (from 1 hour to 24 hours). Then choose the starting hour (Start).

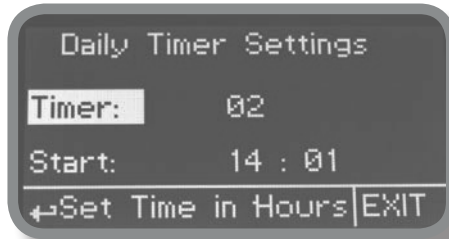

21. "Flow Contact"

Flow contact (locate connection on page 4) can be enabled to stop all dosing activities using a DIRECT contact (N.O. normally opened contact) or REVERSE contact (N.C. normally closed contact). Move wheel for enabling and changing contact logic (DIRECT or REVERSE). Furthermore "Flow contact" can start after a specified time when contact status changes. To set it move wheel on "Time:00 min", click it and rotate to choose time (from 0 to 99 minutes). Confirm selection by clicking wheel.

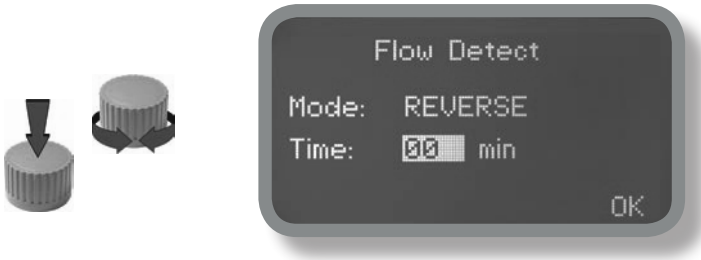

22. "Service"

This "view only" menu shows probes reading live. Press "ESC" to exit.



23. "Digital Inputs" - Contact mode for inputs

This function sets contact type for each digital input. Contact type can be set as N.O. (normally open contact) or N.C. (normally closed contact). Using the wheel move on required input, press wheel then rotate the wheel to choose between N.O. or N.C.



To end procedure move cursor on "OK" and press wheel to proceed to "Save" request screen. Move wheel on "YES" to save or "NO" to discard changes.

24. "Temp. Compensation" - Temperature compensation

pH measurements are temperature dependent. The degree to which temperature affects mV readings varies from solution to solution and can be calculated using the following graphic.

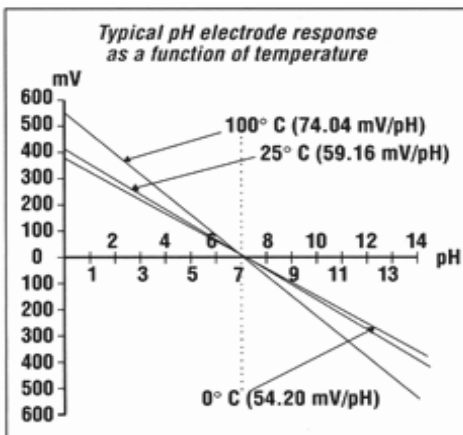

Instrument has either fixed or adjustable automatic temperature compensation referenced to a standard temperature of 25°C.

25. "LOG SETUP" - Activities log setup

This function records instrument activity (date, hour, temperature, uS, totalizer I/O, alarms, outputs). It starts for selected frequency period (every) at requested time (time).

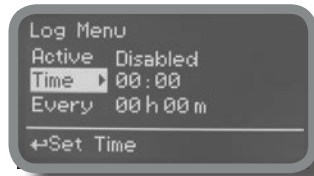

Set ACTIVE to "enabled" to activate log recording.

TIME: recording start time (time format 23h e 59min)

EVERY: recording frequency (time format 23h e 59min)

Note: advanced log control (graph, printing, comparison tables, event filtering, etc) is available through "ERMES Communication Software" for PC.

See "ERMES Communication Software" manual for proper PC software configuration.

26. "LOG VIEW" - Activities log viewer

To see alarm log entries as set on log menu choose "log view" on main menu.

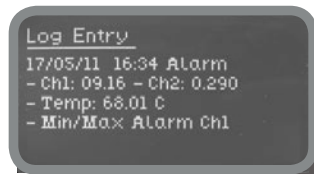

SET DATE & TIME BEFORE TO ENABLE LOG. IF NOT POWERED FOR ABOUT 30 DAYS THE INSTRUMENT WILL LOOSE DATE/TIME

27. "RS485" - Communication port setup

Prior to install the instrument into an RS485 local system a unique ID NUMBER (from 1 to 30) and ID NAME (station name) must be set. Rotate wheel and edit fields. If ID number has already assigned an error message will follow after ID Check (move cursor on CHECK and press wheel). In this event try using another number.

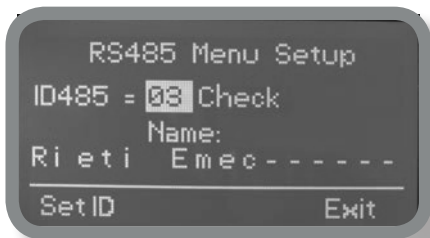

28. "SMS Menu"

Instrument may remotely send SMS alarm messages using its own modem (sold as option). It can be configured as follows:

SMS1 / SMS2 /SMS3.

Using the wheel enter a mobile phone that will receive alert SMS messages if something wrong occurs. SMS number must be set using local number format. For example : 3391349134 will send an SMS message to mobile phone. Log level (and SMS frequency alert) may be set using options in "ACTIVE MSG" within "GSM menu".



- TO AVOID UNDESIRED MESSAGES USE CAREFULLY LOG SETUP -

- WARNING: THIS FUNCTION COULD NOT BE FREE OF CHARGE. DEPENDING ON YOUR OPERATOR CONTRACT IT COULD GENERATE PAYING SMS TRAFFIC !

Legend:

Msg Flow: flow alarm

Msg Lev pH: pH level alarm

Msg Lev Ox: Oxygen level alarm

Msg Dos pH: pH dosing alarm (see "dosing alarm menu")

Msg Dos OX: Oxygen dosing alarm (see "dosing alarm menu")

29. "TCP/IP" - LAN setup

The instrument may be remotely operated using a standard ethernet connection (sold as option). A static or dynamic IP address and a CAT5 ethernet cable is required. According to your network capacity connection speed is 10/100Mbps. To obtain a valid IP address and subnet mask contact your net administrator. Enter parameters and move cursor on "SAVE" to store parameters then move on "OK" and press wheel to save and activate configuration.

Based on your network configuration choose to obtain network parameters automatically (DYNAMIC) or manually (STATIC).



See "ERMES Communication Software" manual for proper PC software configuration.

What is a static IP address/dynamic IP address?

A static IP address is a number (in the form of a dotted quad) that is assigned to a computer by an Internet service provider (ISP) to be its permanent address on the Internet. Computers use IP addresses to locate and talk to each other on the Internet, much the same way people use phone numbers to locate and talk to one another on the telephone. When you want to visit whatis.com, your computer asks a domain name system (DNS) server (think telephone information operator) for the correct dotted quad number (think phone number) for whatis.com and your computer uses the answer it receives to connect to the whatis.com server. It would be simple if every computer that connects to the Internet could have its own static IP number, but when the Internet was first conceived, the architects didn't foresee the need for an unlimited number of IP addresses. Consequently, there are not enough IP numbers to go around. To get around that problem, many Internet service providers limit the number of static IP addresses they allocate, and economize on the remaining number of IP addresses they possess by temporarily assigning an IP address to a requesting Dynamic Host Configuration Protocol (DHCP) computer from a pool of IP addresses. The temporary IP address is called a dynamic IP address.

Requesting DHCP computers receive a dynamic IP address (think temporary phone number) for the duration of that Internet session or for some other specified amount of time. Once the user disconnects from the Internet, their dynamic IP address goes back into the IP address pool so it can be assigned to another user. Even if the user reconnects immediately, odds are they will not be assigned the same IP address from the pool. To keep our telephone analogy going, using a dynamic IP address is similar to using a pay phone. Unless there is a reason to receive a call, the user does not care what number he or she is calling from.

There are times, however, when users who connect to the Internet using dynamic IP wish to allow other computers to locate them. Perhaps they want to use CU-SeeMe or use a VoIP application to make long distance phone calls using their IP connection. In that case, they would need a static IP address. The user has two choices; they can contact their ISP and request a static IP address, or they can use a dynamic DNS service. Either choice will probably involve an additional monthly fee.

Using a dynamic DNS service works as if there was an old-fashioned telephone message service at your computer's disposal. When a user registers with a DNS service and connects to the Internet with a dynamic IP address, the user's computer contacts the DNS service and lets them know what IP address it has been assigned from the pool; the service works with the DNS server to forward the correct address to the requesting DHCP computer. (Think of calling the message service and saying "Hi. I can be reached at 435.44.32.111 right now. Please tell anyone who tries to reach me to call that number.") Using a dynamic DNS service to arrange for computers to find you even though you are using a dynamic IP address is the next-best thing to having a static IP.

Appendix Communication - Software

“GPRS” menu.

Instrument may be remotely operated using an embedded standard GPRS modem (sold as option). In order to activate this service please ensure that the following steps are correctly completed:

- Make certain the antenna location is not shielded by metal objects or near sources of electrical 'noise'.
- Make certain the distance from the antenna to the “Instrument” unit is within cable length.
- Do not route the cable where it could be pinched in doors, windows etc.
- Ensure that SIM into “Instrument” modem is correctly inserted, activated and within operator range.

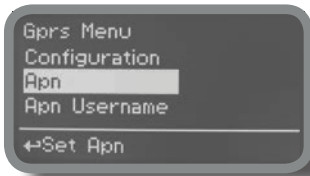

Instrument can be set for ERMES services enabled (Configuration option set to “ERMES YES”) or messages only (Configuration option set to “ERMES NO”) based on your SIM data access parameters. For manual configuration option enter APN (access point name) and SIM phone number. Move wheel on “OK” to save and move on “ESC” to go back to main menu.

Don't forget to enter SIM CODE into PIN NUMBER menu to unlock SIM.

WARNING: THIS FUNCTION COULD NOT BE FREE OF CHARGE. DEPENDING ON YOUR OPERATOR CONTRACT IT COULD GENERATE PAYING DATA TRAFFIC !

“Email” menu.

If Ethernet module or GPRS module is installed (sold as option) the instrument can be configured to send email alarm messages up to two recipients. Click on “Email 1” or “Email 2” and enter email address.

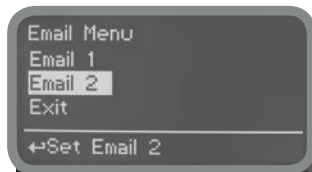

Access point name (APN) identifies an IP packet data network (PDN), that a mobile data user wants to communicate with. In addition to identifying a PDN, an APN may also be used to define the type of service, (eg connection to wireless application protocol (WAP) server, multimedia messaging service (MMS)), that is provided by the PDN. APN is used in 3GPP data access networks, eg general packet radio service (GPRS), evolved packet core (EPC).

32. Technical information.

Power supply: 230 VAC (190+265 VAC)
 pH range: 0 +14
 Pump Strokes: 0 + 180
 Suction Height: 1,5 metres
 Environment Temperature: -10 + 45°C (14 + 113°F)
 Chemical Temperature: 0 + 50°C (32 + 122°F)
 Installation Class: II
 Pollution Level: 2
 Audible Noise (single head): 74dba
 Packaging and Transporting Temperature: -10 + 50°C (14 + 122°F)
 Protection degree: IP 65

| Recommended Chemicals Table | | |
|-----------------------------|---|-------------------------|
| Chemical Product | Formula | Maximum % Concentration |
| Hydrochloric Acid | HCl | 33% |
| Sulphuric Acid | H ₂ SO ₄ | 96% |
| Sodium Bisulphate | NaHSO ₄ | 37% |
| Sodium Chlorite | Na ClO ₂ | 30% |
| Sodium Hypochlorite | Na OCl | 13.5% |
| Calcium Hypochlorite | Ca (ClO) ₂ | 2% |
| Dichloroisocyanuric Sodium | (CON) ₃ Cl Na | 4% |
| Alluminium Sulphate | Al ₂ (SO ₄) ₃ | 18% |
| Ferric Chloride | Fe Cl ₃ | 40% |

| Product | Formula | Ceram. | PVDF | PP | PVC | SS 316 | PMMA | Hastel. | PTFE | FPM | EPDM | NBR | PE |
|------------------------------------|---|--------|------|----|-----|--------|------|---------|------|-----|------|-----|----|
| Acetic Acid, Max 75% | CH ₃ COOH | 2 | 1 | 1 | 1 | 1 | 3 | 1 | 1 | 3 | 1 | 3 | 1 |
| Hydrochloric Acid, Concentrate | HCl | 1 | 1 | 1 | 1 | 3 | 1 | 1 | 1 | 1 | 3 | 3 | 1 |
| Hydrofluoric Acid 40% | H ₂ F ₂ | 3 | 1 | 1 | 2 | 3 | 3 | 2 | 1 | 1 | 3 | 3 | 1 |
| Phosphoric Acid, 50% | H ₃ PO ₄ | 1 | 1 | 1 | 1 | 2 | 1 | 1 | 1 | 1 | 1 | 3 | 1 |
| Nitric Acid, 65% | HNO ₃ | 1 | 1 | 2 | 3 | 2 | 3 | 1 | 1 | 1 | 3 | 3 | 2 |
| Sulphuric Acid, 85% | H ₂ SO ₄ | 1 | 1 | 1 | 1 | 2 | 3 | 1 | 1 | 1 | 3 | 3 | 1 |
| Sulphuric Acid, 98.5% | H ₂ SO ₄ | 1 | 1 | 3 | 3 | 3 | 3 | 1 | 1 | 1 | 3 | 3 | 3 |
| Amines | R-NH ₂ | 1 | 2 | 1 | 3 | 1 | - | 1 | 1 | 3 | 2 | 3 | 1 |
| Sodium Bisulphite | NaHSO ₃ | 1 | 1 | 1 | 1 | 2 | 1 | 1 | 1 | 1 | 1 | 1 | 1 |
| Sodium Carbonate (Soda) | Na ₂ CO ₃ | 2 | 1 | 1 | 1 | 1 | 1 | 1 | 1 | 2 | 1 | 1 | 1 |
| Ferric Chloride | FeCl ₃ | 1 | 1 | 1 | 1 | 3 | 1 | 1 | 1 | 1 | 1 | 1 | 1 |
| Calcium Hydroxide (Slaked Lime) | Ca(OH) ₂ | 1 | 1 | 1 | 1 | 1 | 1 | 1 | 1 | 1 | 1 | 1 | 1 |
| Sodium Hydroxide (Caustic Soda) | NaOH | 2 | 1 | 1 | 1 | 1 | 1 | 1 | 1 | 2 | 1 | 2 | 1 |
| Calcium Hypochlor (Chlor.ted Lime) | Ca(OCl) ₂ | 1 | 1 | 1 | 1 | 3 | 1 | 1 | 1 | 1 | 1 | 3 | 1 |
| Sodium Hypochlorite, 12.5% | NaOCl + NaCl | 1 | 1 | 2 | 1 | 3 | 1 | 1 | 1 | 1 | 1 | 2 | 2 |
| Potassium Permanganate, 10% | KMnO ₄ | 1 | 1 | 1 | 1 | 1 | 1 | 1 | 1 | 1 | 1 | 3 | 1 |
| Hydrogen Peroxide, 30% (Perydrol) | H ₂ O ₂ | 1 | 1 | 1 | 1 | 1 | 3 | 1 | 1 | 1 | 2 | 3 | 1 |
| Aluminium Sulphate | Al ₂ (SO ₄) ₃ | 1 | 1 | 1 | 1 | 1 | 1 | 1 | 1 | 1 | 1 | 1 | 1 |
| Copper-II-Sulphate (Roman Vitriol) | CuSO ₄ | 1 | 1 | 1 | 1 | 1 | 1 | 1 | 1 | 1 | 1 | 1 | 1 |

Resistance rating: (1: Resistant) ; (2: Fairly resistant) ; (3: Not resistant)

Polyvinylidene fluoride (PVDF) Pump Heads, valves, fitting, tubing

Polypropylene (PP) Pump Heads, valves, fitting, level floater

PVC Pump Heads

Stainless steel (SS 316) Pump Heads, valves

Polymethyl Metacrilate (Acrylic) PMMA Pump Heads

Hastelloy C-276 Injection valve spring

Polytetrafluoroethylene (PTFE) Diaphragm

Fluorocarbon (Viton® B) Sealings

Ethylene propylene (EPDM) Sealings

Nitrile (NBR) Sealings

Polyethylene (PE) Tubing

33. Dimensions.

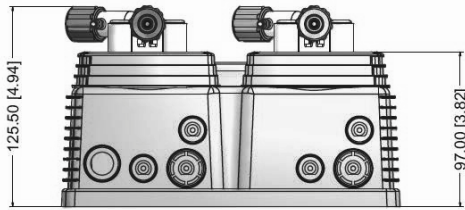

mm [inches]

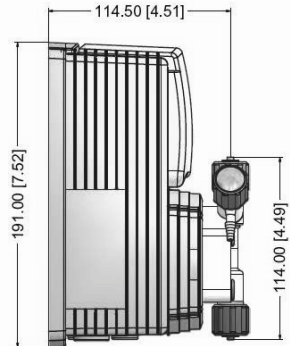
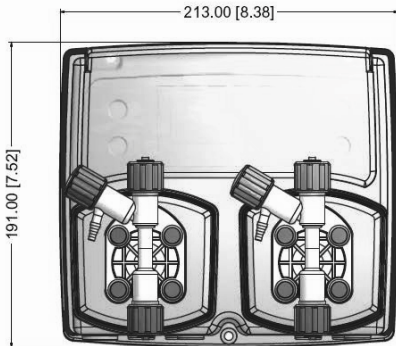

WARNING
IF EQUIPMENT IS SUPPLIED WITH A PLUG:

If an appliance coupler or separable plug is used as the disconnecting device, it shall be readily identifiable and easily reached by the operator. For single-phase portable equipment, a plug on a cord of length not greater than 3m is considered to be easily reached.



WARNING
IF EQUIPMENT IS NOT SUPPLIED WITH A PLUG:

- a) a switch or circuit-breaker shall be included in the building installation
- b) it shall be in close proximity to the equipment and within easy reach of the operator
- c) it shall be marked as the disconnecting device for the equipment

Information on this manual may contain technical inaccuracies or typographical errors.
The information contained may be changed at any time without prior notification or obligation.

34. Board connections.

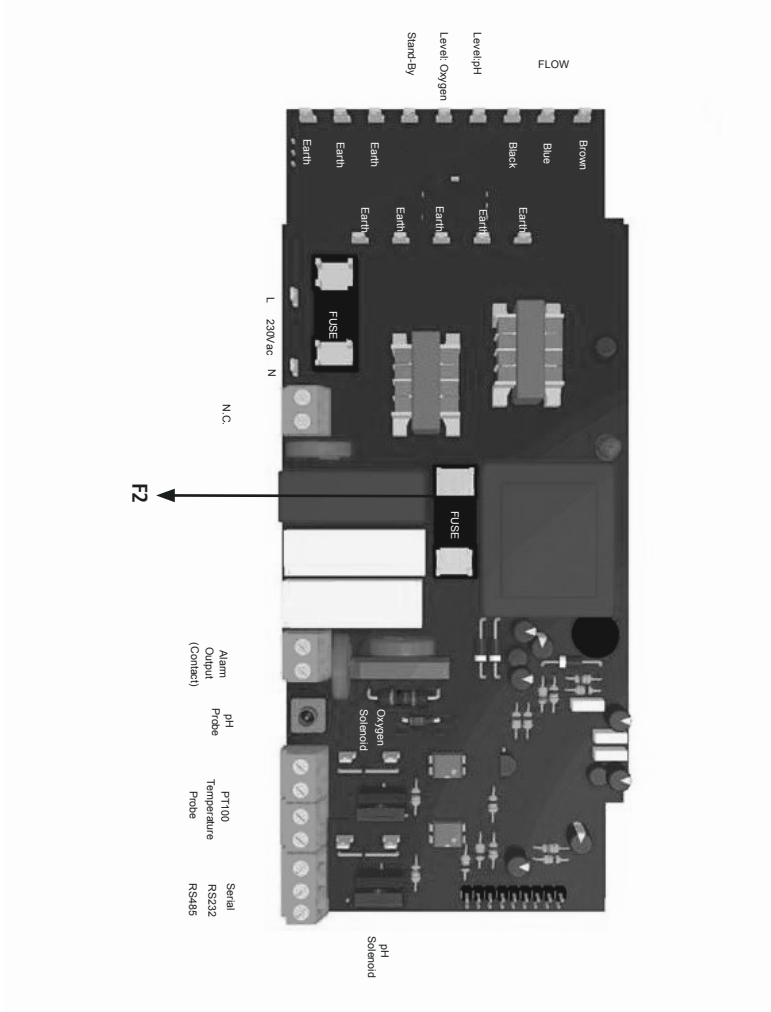

Information on this manual may contain technical inaccuracies or typographical errors. The information contained may be changed at any time without prior notification or obligation.

| | |
|-------------------------------------|---------|
| CE Conformity Declaration | pag. 2 |
| Main safety guide | pag. 2 |
| | |
| Introduction | pag. 3 |
| The wheel | pag. 3 |
| | |
| Connections | pag. 4 |
| Connections, hoses | pag. 5 |
| Connections, level probe | pag. 6 |
| Connections, pump head | pag. 7 |
| Main screen | pag. 8 |
| Quick status check | pag. 9 |
| Password | pag. 10 |
| | |
| “Main menu” | pag. 11 |
| “Temp. Compensation” | pag. 31 |
| “Set point” pH (ON/OFF) | pag. 13 |
| “Set point” pH (Proportional) | pag. 15 |
| “Calibration”, pH | pag. 16 |
| “Calibration”, Temperature | pag. 18 |
| “Parameters” | pag. 19 |
| “Pump Activities” | pag. 20 |
| “Instrument Reset” | pag. 21 |
| “Max Strokes settings” | pag. 21 |
| “Oxygen pump setting & test” | pag. 22 |
| “Volume of pools” | pag. 24 |
| “Dosing Alarm” | pag. 25 |
| “International” | pag. 26 |
| “Probe Failure” | pag. 27 |
| “Weekly Timer” | pag. 28 |
| “Daily Timer” | pag. 29 |
| “Flow” | pag. 30 |
| “Service” | pag. 30 |
| “Digital Inputs” | pag. 31 |
| “Log View” | pag. 32 |
| “TCP/IP” | pag. 34 |
| “GPRS” | pag. 35 |
| “Email” | pag. 35 |
| “Digital Inputs” | pag. 31 |
| | |
| Technical information | pag. 36 |
| Dimensions | pag. 37 |
| Board electrical connections | pag. 38 |



Disposal of end-of-life equipment by users

This symbol warns you not to dispose of the product with normal waste. Respect human health and the environment by giving the discarded equipment to a designated collection center for the recycling of electronic and electrical equipment. For more information visit the online site.



When dismantling a pump please separate material types and send them according to local recycling disposal requirements. We appreciate your efforts in supporting your local Recycle Environmental Program. Working together we'll form an active union to assure the world's invaluable resources are conserved.