

Chlorine Dioxide Generator LOTUS MINI



READ CHAPTER 5 "STARTUP" FOR FIRST START



DOWNLOAD ERMES COMMUNICATION
SOFTWARE

Operation Manual



**Read this manual completely before you start LOTUS.
Do not trash this manual and store it nearby the generator for later use.**



This manual contains important information about the installation and operation safety. Take care about the following instructions to avoid personal injuries and material damages! The operator is responsible in case of damages caused by installation and operation failures!

Chlorine dioxide, like all oxidizing agents, could produce corrosion phenomena of the plant. It is advisable to perform cadenced checks and to treat the plant with specific chemical products. It is also advisable to use chlorine dioxide resistant materials at the point of injection of the product.



English

R5-05-18



NORME CE
EC RULES(STANDARD
EC) NORMAS DE LA CE

Direttiva Bassa
Tensione Low Voltage
Directive Directiva de
baja tensión

2014/35/UE

Direttiva EMC Compatibilità Elettromagnetica EMC
electromagnetic compatibility directive
EMC directiva de compatibilidad electromagnética

2014/30/UE

Direttiva Macchine/Directive on machinery/Directiva de
máquinas =>(2006/42/CE)

2006/42/CE



GENERAL SAFETY GUIDELINES

Danger!

In emergencies the instrument should be switched off immediately! Disconnect the power cable from the power supply!

When installing always observe local regulations!

Manufacturer is not liable for any unauthorized use or misuse of this product that may cause injury, damage to persons and / or materials.

Caution!

Instrument must be accessible at all times for both operating and servicing. Access must not be obstructed in any way!

Feeder should be interlocked with a no-flow protection device to automatically shut-off the pumps when there is no flow!

Pumps and accessories must be serviced and repaired by qualified and authorized personnel only! Always discharge the liquid end before servicing the instrument!

Empty and rinse the liquid end before work on a pump which has been used with hazardous or unknown chemicals!



Always read chemical safety datasheet!

Always wear protective clothing when handling hazardous or unknown chemicals! Instrument must be operated / serviced by trained technicians only!

All connection operations must be performed while the instrument is not connected to main supply!

Directory

1.	General Safety Guidelines	4
1.1	Symbols	4
1.2	Safety instructions	4
1.3	CE-Conformity	5
2.	General Description	6
3.	Construction	7
3.1	Construction overview	7
3.2	Description and details	7
4.	„LOTUS“ - Controller	8
4.1	Start display	8
4.2	Main display	8
4.3	Control element „Click-Wheel“	8
4.4	Status displays	9
4.5	Logbook	10
4.6	Help	10
5.	Adjustment of production capacity	11
5.1	Proportional mode	12
5.2	Constant mode	13
5.4	Batch mode	14
6.	Replacement of chemical cans and pump priming	15
7.	LOTUS Terminal board	16
8.	Technical Data	17
9.	Failure Messages	18
	Communication	21

NOTE:

WHEN CHANGING WORKING MODE, SETPOINT PARAMETERS SHOULD BE ENTERED AGAIN.

1. General Safety Guidelines

1.1 General remarks

This manual includes basic directions for the assembling, operation and maintenance. Therefore it is obligatory for the assembly technician as well as for the operator to study the complete manual before starting with the installation and start-up. This manual must be present at the generator at any time.

It is also obligatory for the operator to consider the general directions in chapter "Safety instructions" as well as the specific safety instructions included in the other chapters of this manual.



Notice:

- For some of the following described functions additional accessories (not included in the delivery scope of LOTUS) may be required.
- Depending to the software release of the LOTUS-controller some of the described features may not be available. Or some functions are available, but not described in this manual. Please contact your dealer in case of the requirement for more information.

1.2 Symbols

In accordance to the guideline DIN 4844-W9 about the characterization of special risks all safety instructions in this manual are labeled with the following symbols:



Warning:

This symbol is warning about risks. Disregarding may cause heavy personal injuries and material damages.



Caution!

This symbol is warning about troubles caused by incorrect operation.



Notice or advice:

This symbol shows important additional information.



Warning: risk of explosion

1.3 Safety instructions

The appropriate use of the LOTUS generator is described in this manual.



Warning:

- The un-appropriate use affects the safety function of this generator and other connected devices and is therefore strictly forbidden.
- Assembling and maintenance has to be done by authorized technicians only.
- Maintenance repairs have to be executed only by the manufacturer or authorized technicians. Interventions or changes at the device in opposite to the regular maintenance in accordance to this manual are incorrect and make the all warranty claims nugatory.
- The operator is liable for the observance of the local safety instructions.
- For the operation and service the device must be accessible at all times.
- Before starting service at the dosing pumps make the pump-heads pressure-less.

- Drain and flush the pump-heads with clean water before starting the service.
- Take attention to the chemical safety data sheets!
- Wear protection clothes for the handling with unknown and hazardous chemicals.

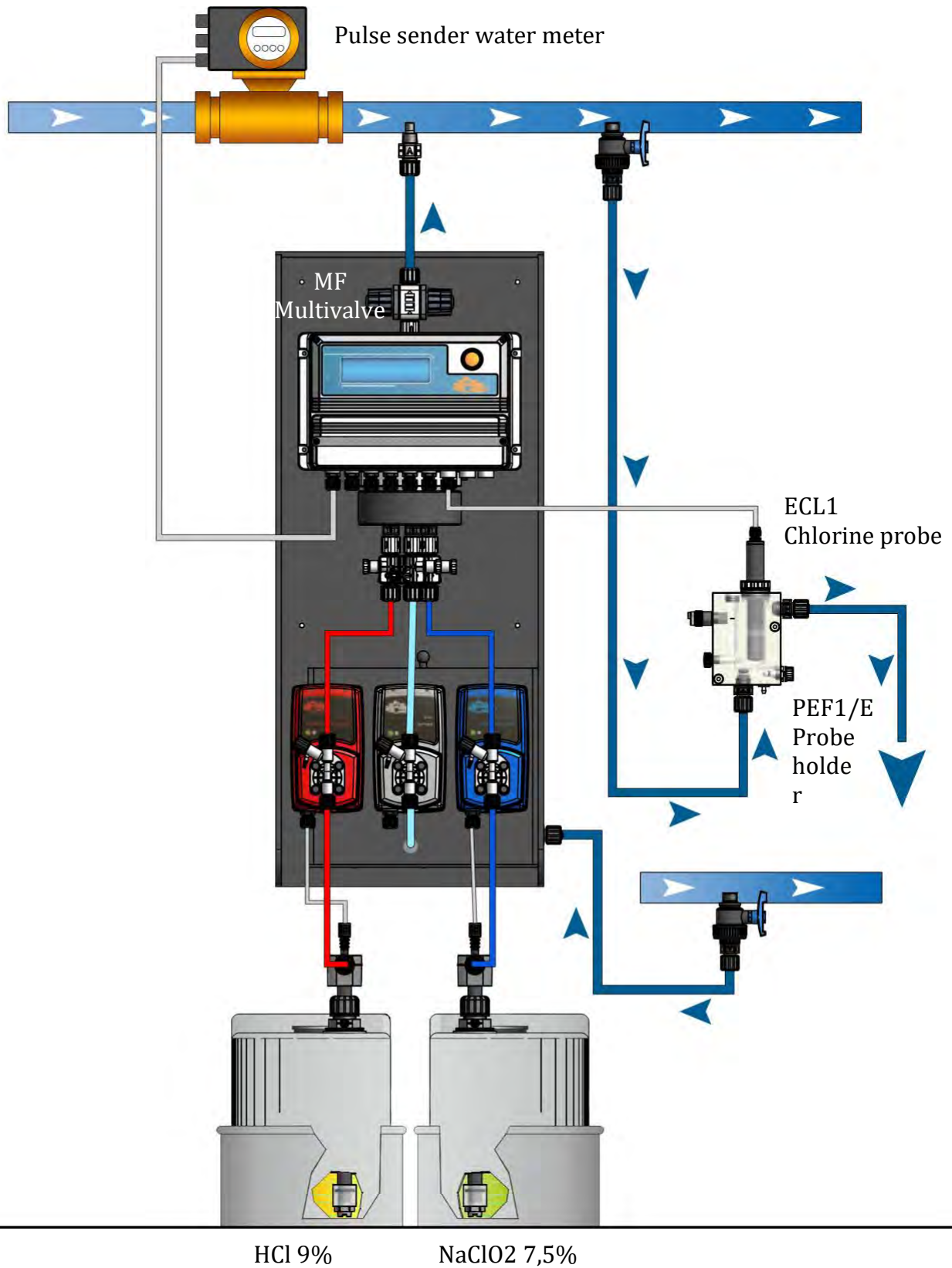



Directions for the operator

(Specific information for applicable regulations in Germany):

- Accident prevention regulation (UVV) „Chlorination of water“, GUV V-D5 E.
- „Dosing plants for chlorine dioxide“, DVGW guideline W 624 (latest version respectively).
- „Chlorine dioxide in water treatment“, DVGW worksheet W 224 (latest version respectively).
- Guidelines for the protection of groundwater against pollution. (§ 19 Federal Water Act – WHG dated 23.9.1986).
- Ordinance of hazardous substances (GefStoffV) – especially § 17 (obligatory protection) and § 20 (operation instruction).



Notice:

A declaration of conformity can be ordered from the manufacturer.



Warning!

The reactor can explode

In case of an uncontrolled sucking of the chemicals into the reactor, caused by a vacuum in the bypass-line and a simultaneous formation of gas/water mixed phases, chlorine dioxide can gas out. Under adverse circumstances, the critical gas concentration is exceeded and an explosion of the reactor can occur. Take appropriate measures to ensure that the bypass line of the LOTUS system does not become subject to a vacuum.

2. General Description

The chlorine dioxide generator is used for the production of liquid chlorine dioxide. This disinfection agent kills all bacteria, germs, viruses and fungi within shortest time – and it works with very low concentration.

The generator is working with the hydrochloric acid – chlorite process and uses diluted chemicals like hydrochloric acid (HCl 9%) and sodium chlorite (NaClO₂ 7.5%) in accordance to the following chemical equation:

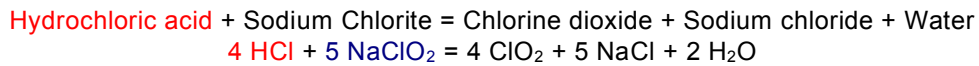

In the process each chemical is pumped with a specific proportion into a chamber vessel [5] by two dosing pumps [2 and 4]. Each stroke from each pump is triggered by the LOTUS-controller [1] and counter-controlled by a “SEFL” [6].

Inside the chamber vessel the chemicals are reacting to chlorine dioxide with a concentration of 2% (= 20 g/l). In the next step a specific proportion of water is pumped into the chamber by a third dosing pump [3] to dilute the chlorine dioxide down to a concentration of approx. 2 g/l.

The finished chlorine dioxide leaves the chamber vessel through a back pressure valve [7] on the top of the chamber.

The advantages are:

- The chlorine dioxide can be pumped direct into pressurized systems with the pressure of the pumps and likewise into pressure-less storing tanks, to distribute the disinfection to different points of use.
- The System can work in proportional mode with contact water meter, current signal or chlorine dioxide measurement.

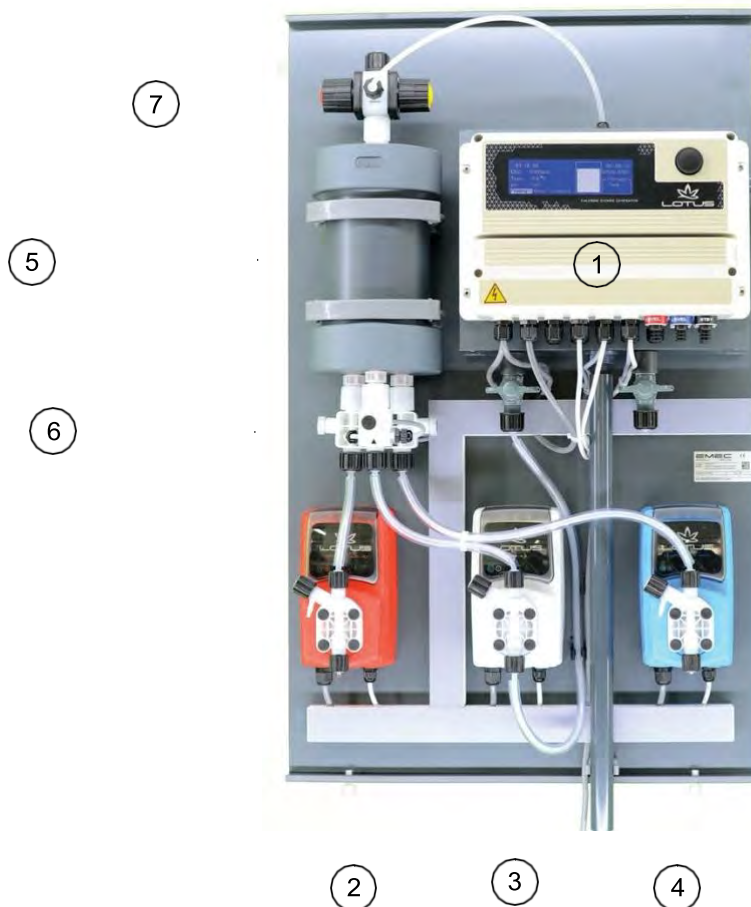

3. Construction

3.1 Construction overview

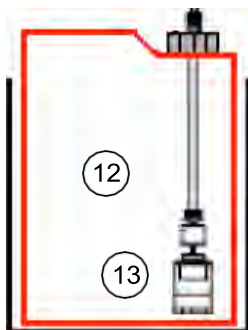
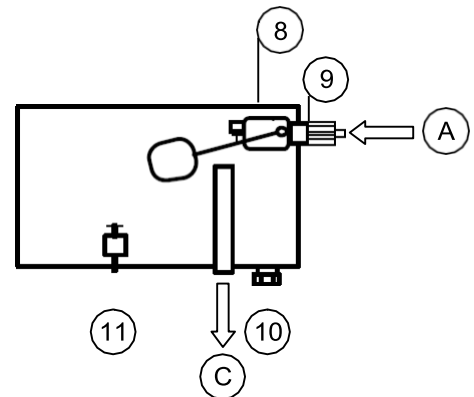
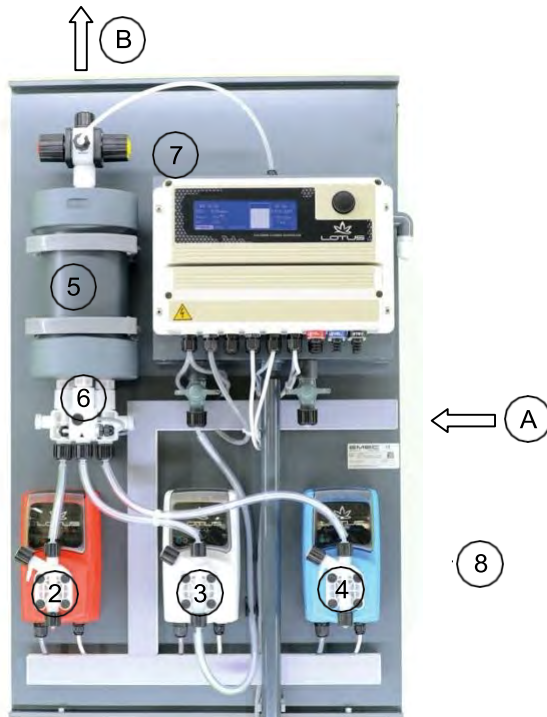

HCl 9%

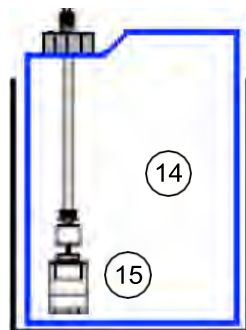

NaClO₂ 7,5%

3.2 Description and details

- | | |
|--|---|
| <ul style="list-style-type: none"> 1 LOTUS-controller 2 Dosing pump for hydrochloric acid (HCl 9%) 3 Dosing pump for dilution water 4 Dosing pump for sodium chlorite (NaClO₂ 7,5%) 5 Chamber 6 Dosing control "SEFL"
each for hydrochloric acid, sodium chlorite
and dilution water 7 PVDF check-valve with hose-connection 4x6 mm 8 Storage tank for dilution water
(located behind the dosing pumps) 9 Floating valve | <ul style="list-style-type: none"> 10 Drain nozzle ½" 11 Level switch „Dilution water tank empty“ 12 Can with hydrochloric acid 9 % (ca. 95 g/l) 13 Suction lance with level-switch „Hydrochloric acid“ 14 Can with sodium chlorite 7,5 % (ca. 80 g/l) 15 Suction lance with level-switch „Sodium chlorite“ |
|--|---|
- A Hose-connection 4x6 mm for dilution water
 B Hose-connection 4x6 mm for chlorine dioxide (for PVDF hose)
 C Dilution water storage tank overflow

4. „LOTUS“ Controller

4.1 Start display

When the power supply is switched on the start display appears and shows the actual software release for some seconds.



After approx. 3 seconds the program goes onto the main display.

4.2 Main display



The main display is separated into 5 lines::

- 1: Date and time
- 2: Measuring value for temperature (in case this option is implemented)
- 3: Type of plant
- 4: Information line for operation, status or failure messages (blinking)
- 5: "Click-Wheel" operation and duty line.
A constant running bar shows that LOTUS is active.

4.3 Control element „Click-Wheel“

On the right side of the display a turning- and push-button is located. It is called „Click-Wheel“.

You can turn the click-wheel into both directions to scroll through the menus or select a function. The selected function is shown in an inverse color.

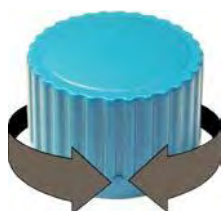

Turn for scroll

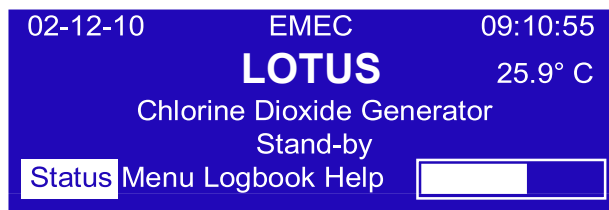

The actual position is shown **Inverse**.



Push for selection



Push the click-wheel for selection.

4.4 Status Displays

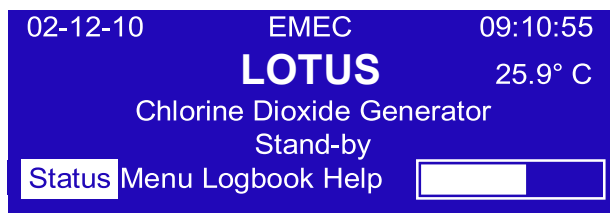

Push the click-wheel on “Status” to open 4 different operation displays:

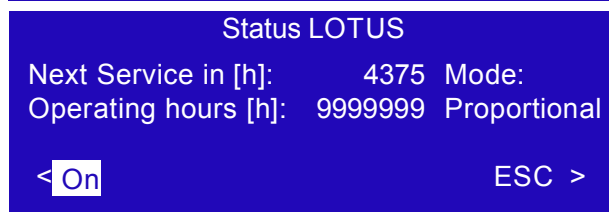
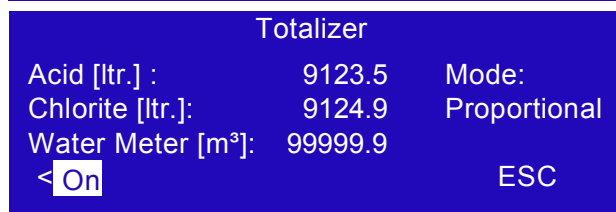
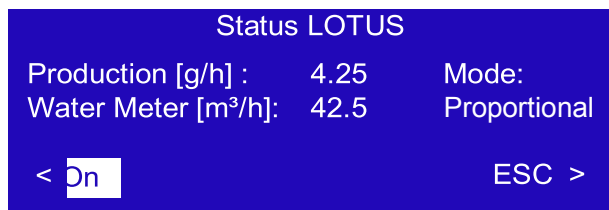
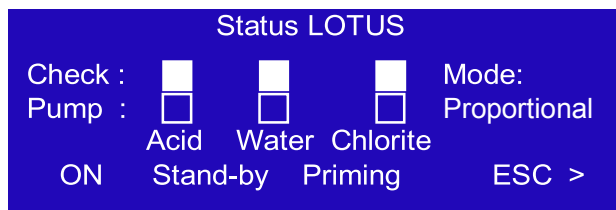

- Check: The signal lights are showing the function of the dosing controls.
At stagnant production the signal light shows .
During production the signal lights from the dosing controls “Check” are blinking inverse corresponding to the signals from the „Pump“.
That means: in the moment when a pump is doing a stroke (light =), the light of the dosing control has to show .
- Pump: See also „Check“.
- Mode: Shows the activated operation mode.
- Production: Shows the actual chlorine dioxide production capacity.
- Water Meter: Shows the actual flow capacity of the contact water meter.
- Next Service: Shows the remaining time until the next service is required.
- Operating hours: Shows the operating hours counter.

In the operation displays you have different options:

- ON/OFF** Start/Stop LOTUS
- STAND-BY** Switches LOTUS into the “Stand-by” mode, independent to the function of the “Stand-by” – Input
- PRIMING** Opens the display for dosing pumps priming resp. for manual mode
- ESC** Go back to the main display
- < or >** Scroll in the operation displays

4.5 Logbook



Turn the click-wheel onto the field “Logbook” and push it to open the sub-menu.

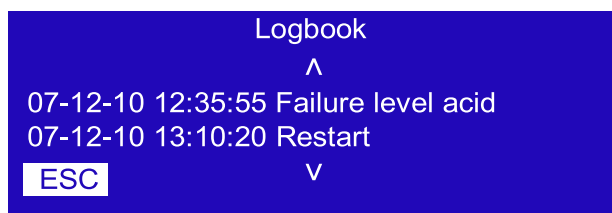
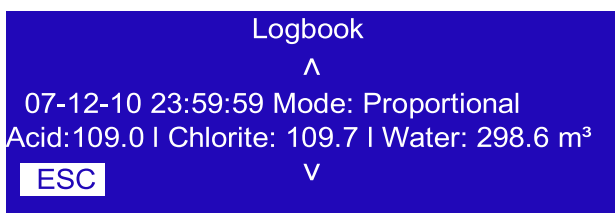

The LOTUS-controller has an internal logbook-memory. Two different types of data are stored together with a time-stamp: Operation data in periodic intervals and failure messages as soon as they appear.

Turn the click-wheel to scroll forward and backwards through the logbook.
Push the click-wheel on “ESC” for return to the main display.

4.6 Help



Turn the click-wheel onto the field “Help” and push it to open the “Help” display.



The “Help” display shows the contact data of your dealer.
Push the click-wheel on “ESC” for the return to the main display.

5. Adjustment of production capacity

Depending to the operation mode the production capacity of LOTUS can be changed.



Push the click-wheel “Menu” to open the display for the adjustment of the production capacity.

The access is protected by an operator passcode:

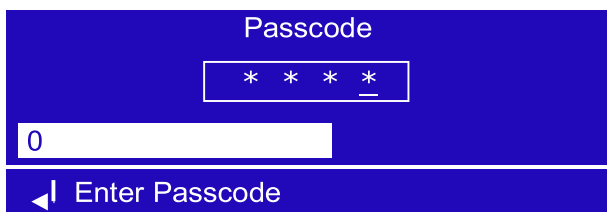

Select a four-digit number-code. As soon as the fourth correct digit is selected the next display opens automatically.



Notice:

The factory default for the operator passcode is “0 0 0 0”.

In case you like to change your passcode please ask your dealer and his technician will do the implementation for you.

Depending to the selected operation mode, different displays are available:

5.1 Proportional mode

In the proportional mode LOTUS produces an adjustable capacity of chlorine dioxide proportional to a water flow recorded by a water meter.

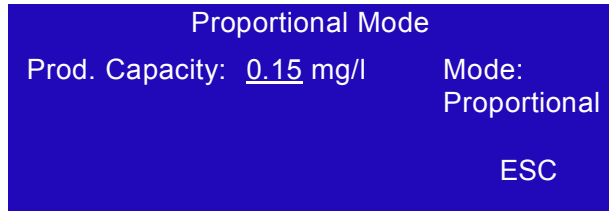

Prod. Capacity: Here you can adjust the requested chlorine dioxide concentration.



Warning:

- The controller takes the inserted value in “*Prod. Capacity*” for the calculation of the required stroke frequency of the dosing pumps for the production of chlorine dioxide proportional to the flow. This means that it is a theoretically value and not the real concentration in the water!
- The operator is responsible by its own for the proper adjustment of this control-value!
- The operator has to countercheck the chlorine dioxide concentration in the connected water system with a suitable photometer to verify the real concentration and to readjust the “*Prod. Capacity*” until the required concentration is stable achieved.



General Notices:

Theoretically it is possible to adjust the production capacity up to 9.99 mg/l.

But for very low water flows, resp. water consumption it can be dangerous to do this and should be absolutely avoided!

In case the water flow exceeds the maximum production capacity a proportional production is not longer possible. In the following table you can find the maximum water flow corresponding to the maximum production capacity:

LOTUS	8	20
Production capacity [mg/l]	Water flow [m³/h]	
0,10	80	200
0,20	40	100
0,30	26.6	66.6
0,40	20	50
0,50	16	40
0,60	13.3	33.3
0,70	11.4	28.5
0,80	10	25
0,90	8.8	22.2
1,00	8	20

The overriding of the maximum possible production capacity caused by the water flow is shown on the display with a special blinking message “*Overflow*”:

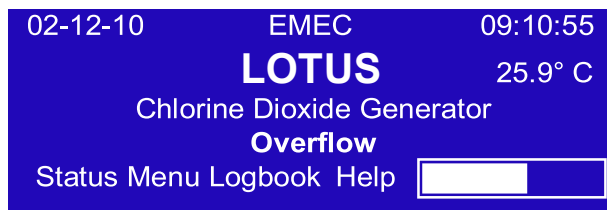

As soon as the water flow drops down under the maximum acceptable value, the message disappears.

5.2 Constant mode

In this mode LOTUS is producing chlorine dioxide with a constant and adjustable capacity as long as input “Stand-by” is not activated. Two different capacities can be adjusted depending to the digital inputs “Batch tank empty” [terminal 29 and 30] and “Stand-by” [terminal 54 and 55].

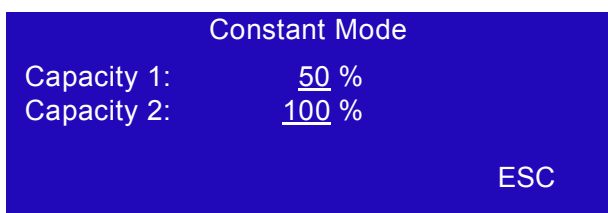

Capacity 1: Here you can adjust the production capacity for the digital input “Batch tank empty”.

Capacity 2: Here you can adjust the production capacity for the digital input “Stand-by”.

Situation	STAND-BY (54, 55)	BATCH TANK EMPTY (29, 30)
LOTUS “STAND-BY”		
Capacity 1		
Capacity 2		



Notice:

Independent to the selected operation mode LOTUS stops as soon as the digital input “Stand-by” appears!

5.3 Batch mode

In this mode LOTUS fills up a level-controlled batch tank with chlorine dioxide in an adjustable concentration. The two digital inputs “Batch tank empty” [terminal 29 and 30] and “Stand-by” [terminal 54 and 55] are used for the level-control.

Because LOTUS runs always with 100% production capacity as soon as it starts, no extra display for the capacity adjustment is available.

Situation	Step	Terminal 29, 30	Level tank empty	Terminal 54, 55	Level tank full
Tank empty	1		<input type="checkbox"/>		<input type="checkbox"/>
Level is rising	2		<input checked="" type="checkbox"/>		<input type="checkbox"/>
Tank full	3		<input checked="" type="checkbox"/>		<input checked="" type="checkbox"/>
Level falls down	4		<input checked="" type="checkbox"/>		<input type="checkbox"/>
Tank empty	1		<input type="checkbox"/>		<input type="checkbox"/>

Step 1:

```

Status
Level Tank full :  Mode:
Level Tank empty :  Batch
Start Filling Batch Tank
< ESC >
  
```

Step 2:

```

Status
Level Tank full :  Mode:
Level Tank empty :  Batch
Filling Batch Tank
< ESC >
  
```

Step 3:

```

Status
Level Tank full :  Mode:
Level Tank empty :  Batch
Batch Tank full
< ESC >
  
```

Step 4:

```

Status
Level Tank full :  Mode:
Level Tank empty :  Batch
Draining Batch Tank
< ESC >
  
```

In case one of the level-switch failed or the cable is damaged a failure message appears:

Failure Level-switch:

```

Status
Level Tank full :  Mode:
Level Tank empty :  Batch
Failure Level-Switch
< ESC >
  
```

```

02-12-10 EMEC 09:10:55
LOTUS 25.9° C
Chlorine Dioxide Generator
Failure Level-Switch
[Status] Menu Logbook Help [ ]
  
```



6. Replacement of chemical cans and pump priming



Warning:

Wear protective clothes for the handling with hazardous chemicals!

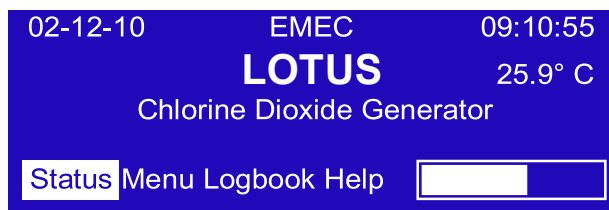
- Replace the chemical can.



- Use the click-wheel, go to „Status“ and then to „Priming“. Push the click-wheel and open the sub-display for the manual mode.

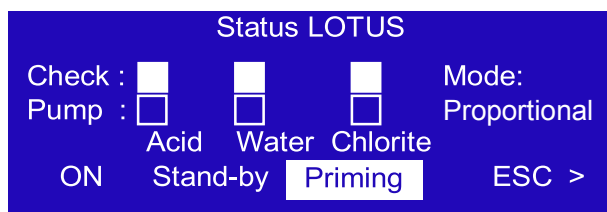

- Insert a time of approx. 1 or 2 minutes in field „Input“ and start the count-down with „Start“. All three pumps start running with max. pulse frequency.

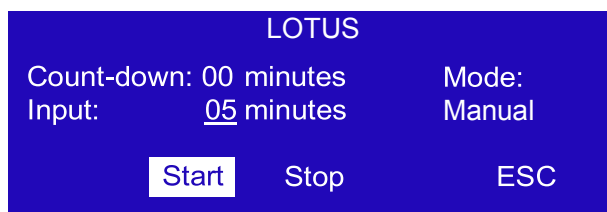

- Open the priming valves at the dosing pump you want to prime. The pumps keep on running until the count-down stops or the process is interrupted with the „Stop“ button.
- Shut the priming valves as soon as the chemicals flow out of the pump-head without gas-bubbles through the priming hose back into the cans.
- Let the pumps keep on running for some more seconds to be sure that rely all gas-bubbles leaved the suction hose and the pump-head in direction to the chamber.
- Push the click-wheel on „ESC“ and leave the priming mode.
- At least check the signal-lights „Check“ and „Pump“ in the „Status“ display for correct working when LOTUS is running. In case the lights are not corresponding LOTUS will stop after a while and you have to repeat the priming procedure.



Caution!

Do not run the plant in priming mode for a longer period without visual control because of the risk for overriding the maximum operation pressure!

Connections to the mainboard

Before performing any operation on the Block board of the instrument, it is mandatory to disconnect it from the mains. To facilitate the connections to the mainboard, it has been divided into two blocks: electrical connections and I/O connections.



Unplug power cable from main power supply before operate

Danger

Blocks numbering is relative to the area on which you are working!

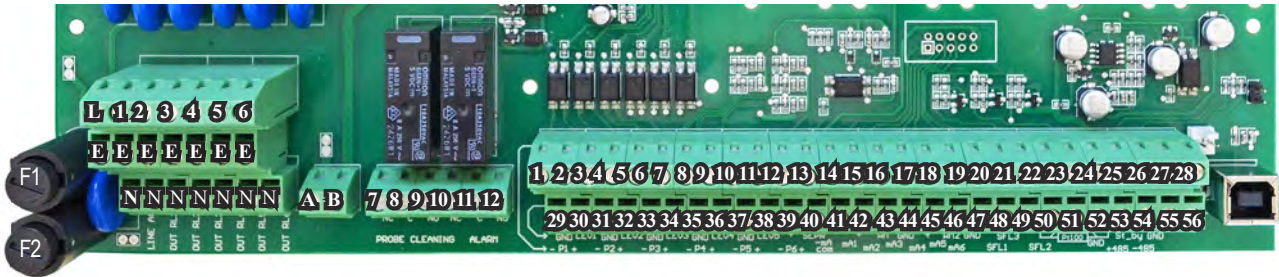

Electrical Connections



I/O Connections

Electrical connections:

F1: Main fuse (6.3AT)

F2: Instrument fuse (3.15AT)

MAIN POWER SUPPLY (115VAC / 240VAC): L(Phase), E(Earth), N(Neutral)

SET-POINT OUTPUTS (115VAC TO 240VAC):

(free contact outputs are not protected with a fuse and isolation between the outputs and the power supply is 250V MAX):

GENERAL ALARM OUTPUT:

5 - E - N (F2 Fuse-protected) Alarm Out

10(N.C.), 11(C), 12(N.O.)

I/O Connections:

OUTPUTS FOR DIGITAL SIGNAL PROPORT. PUMP:

1(-) ; 2(+): Acid pump signal
output 3(-) ; 4(+): Chlorine pump
signal out 5(-) ; 6(+): Water
signal out

INPUTS:

21(-) ; 20(+): SEFL IN 1
23(-) ; 22(+): SEFL IN 2
49(-) ; 48(+): SEFL IN 3

MA OUTPUTS (MAX LOAD 500 OHM):

mA Outputs Active – Do not connect any external
voltage - Driver voltage without load: 15V

13: Common
15: Production
16: Reading

RS485:

26: + Signal 485 (A)
27: - Signal 485 (B)

TANKS LEVEL INPUT:

29(-) ; 30(+): TANK EMPTY BATCH | CAP 2 (Constant Mode)
35(-) 36(+): ACID
;37(-) 38(+): CHLORINE

FLOW sensor (mod. "SEPR") input: 39(+ Brown) ; 40(Black) ; 41(- Blue)

41 shortcut with block n.37

CONTACT input:

39(White) ; 40(Black)
41 shortcut with block n.37

(Hall effect) pulse sender water meter (makeup water):

42(+12VDC) ; 43(INPUT) ; 44(GND)

(Contact) Pulse sender water meter (makeup water):

43(INPUT) ; 44(GND)

Temperature Probe input (mod. "ETEPT"): 50(green) ; 51(brown) ; 52(white) ; 53(yellow)
(remove resistance before to install probe)

Temperature Probe input (PT100) with ECDIND probe: 50(green) ; 51(orange or pink) ; 52(white) ;
53(yellow)

STANDBY input: 54(+) ; 55(GND)* *BATCH TANK FULL / CAP1 CONSTANT

OVERFLOW WATER TANK: 31(-); 32 (+) contact for maximum level into storage tank

LOTUS Terminal board

Attention: all connections must be executed by qualified personnel

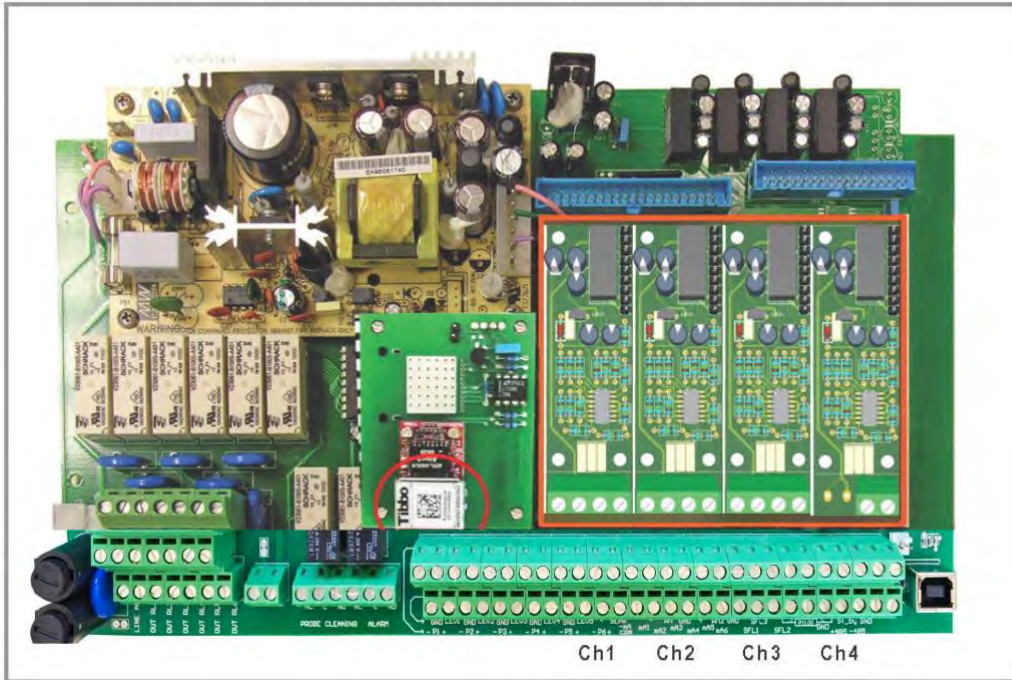

Danger

Unplug power cable from main power supply before operate

MDMA module
0/20 mA water meter
input Slot 4

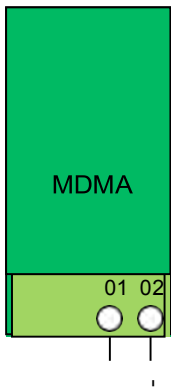

Chlorine dioxide
measuring module
(Option)



Brown (+)
White (-)
Green (Signal)
Yellow (GND)

Chlorine dioxide
measuring module
(Option)



N.C.
N.C.
- (Black)
+ (Red)

Slot

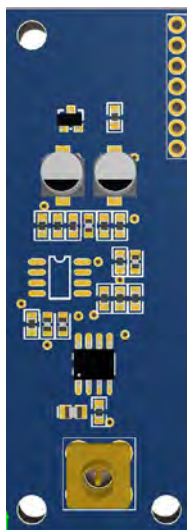

SLOT 3 (option)
mV module for
ORP probe



SLOT 3

Connect chlorine probe (mod. SCLxx) to this module as follows:

- 1 (-485) green wire
- 2 (+485) white wire
- 3 (GND) black wire
- 4 (+5VDC) red wire

ADDENDUM DIOXIDE PROBE SAFETY SYSTEM

Dioxide Probe

Use this function to setup sensor that detects dioxide into air. This option is useful during a plant's dioxide leakage to prevent dangerous high dioxide concentration. To set this value refer to the sensor sensitiveness as printed on head's label (see below picture). **Do not edit this function if not otherwise specified or if unsure of value to enter.**

Other options are:

MAIN MENU: HIDE to not show a warning message. Use exclusively if no sensor is connected.

MAIN MENU: SHOW to enable warning message and related alarm on main screen. Enabled by default.

Attention: this procedure assumes that the instrument is configured properly and connected to a working sensor, otherwise the results may not be reliable.



Dioxide into air main sensor head

Dioxide into air alarm

Use this menu to set a maximum dioxide into air concentration value into environment. Don't change this value if unsure of value to enter. **Do not edit this function if not otherwise specified.**

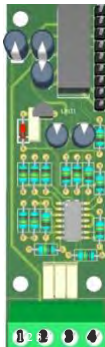

Connection:

Block 1 : (+12VDC) Brown

Block 2 : (-12VDC) White

Block 3 : (V-out) Green

Block 4 : (GND) Yellow

DIOXIDE SENSOR MODULE

Slot 2

Probe (Dioxide Reading) in SETTINGS MENU

It is possible to enable the reading and the related alarms of the dioxide probe also for the working modes that normally do not need reading of the dioxide: COSTANT, BATCH and PROPORTIONAL + WM.

8. Technical Data

		LOTUS MINI 8	LOTUS MINI 20
ClO ₂ production capacity	g/h	8	20
Maximum operation pressure	bar	10	10
Chemical consumption at max. production	l/h	each 0.2	each 0.5
Concentration of ClO ₂ stock solution	g/l	approx. 2 - 20	
Power supply		90 – 265 V, 50/60 Hz	
Energy consumption	w/h	50	
Protection class		IP 65	
Dimension:			
Width	mm	450	
Height	mm	1080	
Depth	mm	360	
Transportation weight	kg	approx. 30	

9. Failure messages

In case of a malfunction a message appears on the display and LOTUS stops.

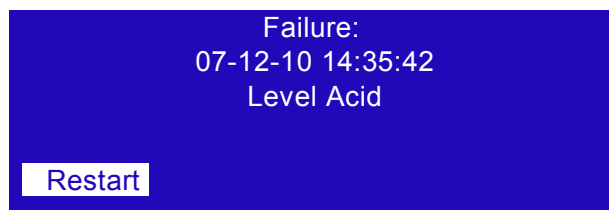

Remove the malfunction and restart LOTUS.

Message	Problem	Solution
Level Acid	One of the chemical cans or the dilution water storage tank is empty.	Change the chemical can and prime the pump.
Level Water		Check the supply line for the dilution water storage tank. Prime the pump.
Level Chlorite		Change the chemical can and prime the pump.
Contact Batch Tank Empty Level	The cable of the level-switch is disconnected or has a damage	Check the proper function of the level-switch. Call the service in case the level-switch is damaged.
Flow control Acid	A dosing control is recognizing lack of or no dosing.	Prime the corresponding pump. Readjust the flow-sensitivity at the dosing control. Call the service in case priming is not successful.
Flow control Water		
Flow control Chlorite		
Contact SEFL Acid	A cable of the dosing control is damaged or disconnected.	Call the service.
Contact SEFL Water		
Contact SEFL Chlorite		
Analog Input	The analog input signal is lower 3.5 mA.	Check the signal supply device. Check the signal cable for damages. Call the service.
Service required		Call an authorized service technician for periodic maintenance.



Notice:

The two alarm output relays (terminal 5-E-N) and (terminal 10 (NC) – 11 (C) – 12 (NO)) are switching on in case of a malfunction. The relays are falling off as soon as the removal of the malfunction is confirmed with the "Restart" button.



COMMUNICATION

COMMUNICATION MENU (TCP/IP - GPRS with MODEM OR ETHERNET MODULE)

This instrument can be controlled and programmed remotely using the system called ERMES and a standard web browser (i.e.: Google Chrome or Safari). In order to use this service an internet connection is required (lan or wan) and user must configure the instrument to obtain a valid IP address (through a valid DHCP service or manually). If this instrument is installed within an office network please contact your system-administrator to obtain required parameters and eventually unlock TCP/IP port 2020.

Things to do before setup.



Network administrator required

1. Ensure that on instrument MAC ADDRESS (see SERVICE menu) the TCP/IP port 2020 is unlocked. Check it with your system-administrator.
2. Connect to your ERMES account or create a new one at: www.ermes-server.com
3. Within ERMES account add the new instrument using the 6 digits code located into SERVICE menu. (choose LAN DEVICE or MODEM code based on connection type chosen prior to buy the instrument)

Parameters to be configured in the communication menu (TCP/IP)

In order to communicate **via LAN cable to ERMES** server the following parameters must be set:



Basic Network skills required

If configuration requires the presence of a ROUTER with automatic IP address assignment from TCP/IP menu select IP MODE and set it to DYNAMIC.

If local LAN needs to provide static IP address then from TCP/IP menu select STATIC IP MODE and enter the following parameters:

IP address: enter the unit unique available IP address using syntax xxx.xxx.xxx.xxx

SUBNET(netmask): range of belonging to the host within a subnet IP. For example:

255.255.255.0 **GATEWAY:** The IP address of the device that routes packets. For

example: 192.168.1.1

DNS: IP address of the device that resolves the names of network nodes.

It is usually the same as the GATEWAY. It can be also a public DNS address (e.g.: 8.8.8.8)

Parameters to be configured in the communication menu (GPRS)

In order to communicate **via GPRS modem to ERMES** server insert SIM into modem's slot the slot.

A data plan subscription is suggested to reduce SIM costs. From GPRS menu set the following parameters:

Ermes SERVER: select YES to activate the traffic data with Ermes server or select NO to use the GPRS modem only for SMA and/or EMAIL alerts messages.

APN: ask SIM mobile company what is the name of the access point designated **APN Username & Password:** ask SIM mobile company both these parameters **PIN:** Enter the assigned 4 digits code to automatically unlock the SIM

COMMUNICATION (MESSAGES Setup -

This instrument can send emails and / or sms when a system failure or warning happens. If instrument is configured to operate through the LAN only email messages can be send. Otherwise if instruments has a mobile modem both SMS and emails messages can be send.

MESSAGES Setup

Within this menu is possible to setup up to three SMS (SMS1, SMS2, SMS3) recipients and two email (email 1, email 2) addresses. Editing MSG ALARM and MSG WARNING ALARM is possible to setup which type of error must be notified (see below table).

MSG warning	MSG alarm
MAXIMUM TIME REACHED	PROBE FLOW ALARM
HCl LEVEL	CHLORINE DIOXIDE IN STORAGE NO LONGER USABLE
NaClO ₂ LEVEL	SYSTEM NOT READY
ST.Tank Full	
SYSTEM NOT READY	

RS485 Setup

This instrument can be connected in a network of instruments via RS485 (max 32) to take advantage of a single modem or LAN connection for remote programming (through ERMES server) or local (ask your provider).

Make the cable connections as described in RS485 terminal blocks and then in the RS485 menu, set the RS485 unique ID NAME for each instrument.

CHECK if entered in ID NAME has been properly accepted by clicking on ID CHECK, if an error message is reported by the instrument modify it.

COMMUNICATION (LOG MENU & LOGBOOK)

This function, when enabled, allows to record and send to ERMES server all instrument activities (date, time, temperature, levels, alarms, totalizers, outputs status) for a set period (EVERY) and starting from a certain time (TIME) .

Note: SET TIME AND DATE PRIOR TO ENABLE THE LOG. If not fed after 30 days the instrument will lose current date and time.

TIME: log starting time (format 23h 59min)

EVERY: frequency of recording (format 23h 59min)

E.g.: To set the instrument to begin logging events starting from 16:00 every hour set TIME to 16h:00 and EVERY of 1h:00m

Note: To view on instrument's display the archived logs select LOGBOOK

ERME

The web-based application ERMES allows plants remote control: with it is possible to read, analyze and modify instruments parameters from PCs, smartphones or tablets.

PLUS

- It reduces plant intervention and inspections.
- It reports on the current status of the network's devices and connections (probes, outputs, alarms, setpoints)
- It instantly gives notification of alarms by sms or email
- It generates an up to date report of all plant instruments
- It can display the instruments activity log as line graphs and charts and it can download it to your pc in excel or pdf format

HOW TO USE WEB ERMES

Enter the website www.ermes-server.com and, after registration, set plants.

EMEC instruments with ETHERNET or GSM/GPRS Configuration will be immediately connected and available for remote control. Furthermore, with ERMES you can receive alarm messages via email, with different report option on instrument status. If instrument has been bought with the GSM/GPRS option it's possible to receive SMS reports on any mobile phone.

Read "COMMUNICATION" chapters to better understand how to configure the instrument.

Troubleshooting

Problem	Possible solution
<p>What to do before to install the SIM into instrument's modem</p>	<p>Check best signal coverage for operator choice.</p> <p>Modem is compatible with the following GSM frequencies: 900 -1800 -1900 MHz (three-band). Not compatible with 3G only operators.</p> <p>SIM type is: Mini-SIM (classica SIM card in uso nei telefoni) Lenght 25 (mm) - Width 15 (mm) - thickness 0,76 (mm)</p> <p>Subscribe to a data plan for monthly traffic activity of about 500MB</p> <p>Make sure PIN REQUEST is OFF. If not insert SIM into a standard mobile phone and disable it.</p>
<p>Several instruments are connected in RS485 mode but the software displays only one</p>	<p>Make sure the termination jumper on the first and last instrument of the chain are closed</p>
<p>The GPRS modem does not connect to the network</p>	<p>Verify the correct insertion of the SIM</p> <p>Verify APN parameters and enter them manually if necessary</p> <p>Make sure the SIM has a data plan active for internet access Make sure the provider supports international roaming DATA if the connection is abroad</p>
<p>The instrument is unable to obtain a valid IP address from the LAN or the software does not connect to it</p>	<p>Make sure the pre-existing network allows auto-assignment of the IP address (automatic DHCP); if it does not, contact the network administrator to obtain the data to enter manually</p> <p>Make sure the network cable is connected to the instrument. Make sure it is a good quality cable and not the "cross" type. CAT 5, 6 and 7 cable types are compatibles</p>
<p>ERMES does not find the instruments via internet that are correctly connected to a LAN</p>	<p>Make sure the internet connection is active</p> <p>Make sure there are no port-blocking third part programs and/or firewalls active that prevent data traffic through the TCP 2020 port</p>

<p>FIRST TIME CONNECTION TO ERMES</p> <p>ERMES is asking for CODE and SERIAL NUMBER during first time access, where are they ?</p>	<p>CODE and SERIAL NUMBER are located on instrument's main label</p>
<p>ADDING AN INSTRUMENT TO ERMES</p> <p>Where is the CODE NUMBER required to add an instrument to the account?</p>	<p>For instrument with LAN access: see SERVICE menu within instrument's software</p> <p>For instrument with GPRS access: enter SIM phone number</p>

MODBUS

Modbus is a serial communications protocol originally published by Modicon (now Schneider Electric) in 1979 for use with its programmable logic controllers (PLCs). Simple and robust, it has since become a de facto standard communication protocol, and it is now a commonly available means of connecting industrial electronic devices.

From main menu select COMMUNICATION then MODBUS to access the options. Set the communication speed according to the PLC system available. Set the ID assigning a UNIQUE address to avoid conflict .

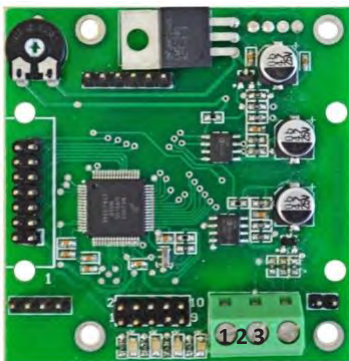
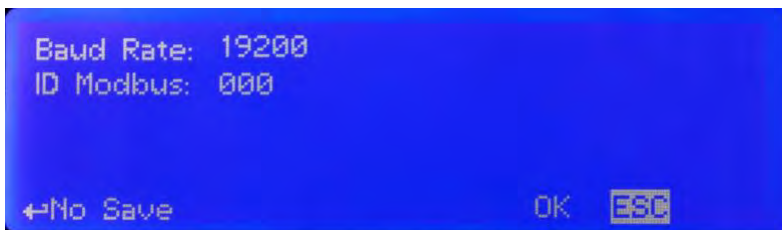

To access the module MODBUS open the instrument only after power is switched off!

Never make connections with the instrument powered!



WARNING

- 1: GND
- 2: A-RS485 (+)
- 3: B-RS485 (-)

Appendix A: Test Certificate

Order No.:			
LOTUS type:		Serial No.:	
Software release:			
Chamber:	Test pressure:	Test temperatur	Test period:
	bar	° C	hours
Dosing pumps:	Acid	Water	Chlorite
Type:			
Calibration value:	ml	ml	ml
Calibration pressure:	bar		
Number of strokes:			
System settings:			
Dos-Check:			
Pass-Code 2:		Default:	
Pass-Code 1:		Default:	
Language	Deutsch / English		
Water meter:		Pulse/Liter	Liter/Pulse
Max. value:		m ³ /h at 20 mA	

Date

Signature

Chlorine Dioxide Generator LOTUS MINI



Installation and Operation Manual

For authorized service engineers only!



**Read this manual completely before you start with the installation and start-up.
Do not trash this manual and store it nearby the generator for later use.**



This manual contains important information about the installation and operation safety.
Take care about the following instructions to avoid personal injuries and material damages!
The operator is responsible in case of damages caused by installation and operation failures!



English



Directory

1.	General Safety Guidelines	4
1.1	Symbols	4
1.2	Safety instructions	4
1.3	CE-Conformity	5
2.	General Description	6
3.	Construction	7
3.1	Construction overview	7
3.2	Description and details	7
4.	Installation	8
4.1	General requirements for the installation location	8
4.2	Requirements to the water	9
4.3	Assembly	9
4.4	Hydraulic installation	10
4.4.1	Installation to a pressure system	10
4.4.2	Installation to a batch tank	13
4.5	Electric Installation	15
4.5.1	Power supply	15
4.5.2	Types of Control	15
5.	First Startup	16
5.1	Preparations	16
5.2	Hydraulic start-up	16
6.	„LOTUS“ - Controller	17
6.1	Start display	17
6.2	Main display	17
6.3	Control element „Click-Wheel“	18
6.4	Status displays	19
6.5	Logbook	20
6.6	Help	20
7.	Main Menu	21
7.1	Pumps – Calibration of the dosing pumps	22
7.2	Probes – Calibration of the chlorine dioxide probe and temperature sensor	22
7.3	Contact water meter	23
7.4	Analog outputs	24
7.5	Operation mode	25
7.5.1	Proportional mode	26
7.5.2	Constant mode	27
7.5.3	Analog mode	27
7.5.4	Batch mode	28
7.5.5	Proportional & Measuring mode	29
7.6	System settings	30
9.	LOTUS Terminal board	31
10.	Technical Data	32
11	Failure Messages	33
Appendix A: Test Certificate		

1. General Safety Guidelines

1.1 General remarks

This manual includes basic directions for the assembling, operation and maintenance. Therefore it is obligatory for the assembly technician as well as for the operator to study the complete manual before starting with the installation and start-up. This manual must be present at the generator at any time.

It is also obligatory for the operator to consider the general directions in chapter "Safety instructions" as well as the specific safety instructions included in the other chapters of this manual.



Notice:

- For some of the following described functions additional accessories (not included in the delivery scope of LOTUS) may be required.
- Depending to the software release of the LOTUS-controller some of the described features may not be available. Or some functions are available, but not described in this manual. Please contact your dealer in case of the requirement for more information.

1.2 Symbols

In accordance to the guideline DIN 4844-W9 about the characterization of special risks all safety instructions in this manual are labeled with the following symbols:



Warning:

This symbol is warning about risks. Disregarding may cause heavy personal injuries and material damages.



Caution!

This symbol is warning about troubles caused by incorrect operation.



Notice or advice:

This symbol shows important additional information.



Warning: risk of explosion

1.3 Safety instructions

The appropriate use of the LOTUS generator is described in this manual.



Warning:

- The un-appropriate use affects the safety function of this generator and other connected devices and is therefore strictly forbidden.
- Assembling and maintenance has to be done by authorized technicians only.
- Maintenance repairs have to be executed only by the manufacturer or authorized technicians. Interventions or changes at the device in opposite to the regular maintenance in accordance to this manual are incorrect and make the all warranty claims nugatory.
- The operator is liable for the observance of the local safety instructions.
- For the operation and service the device must be accessible at all times.

-
- Before starting service at the dosing pumps make the pump-heads pressure-less.
 - Drain and flush the pump-heads with clean water before starting the service.
 - Take attention to the chemical safety data sheets!
 - Wear protection clothes for the handling with unknown and hazardous chemicals.



Directions for the operator

(Specific information for applicable regulations in Germany):

- Accident prevention regulation (UVV) „Chlorination of water“, GUV V-D5 E.
- „Dosing plants for chlorine dioxide“, DVGW guideline W 624 (latest version respectively).
- „Chlorine dioxide in water treatment“, DVGW worksheet W 224 (latest version respectively).
- Guidelines for the protection of groundwater against pollution.
(§ 19 Federal Water Act – WHG dated 23.9.1986).
- Ordinance of hazardous substances (GefStoffV) – especially § 17 (obligatory protection) and § 20 (operation instruction).



Notice:

A declaration of conformity can be ordered from the manufacturer.

2. General Description

The chlorine dioxide generator is used for the production of liquid chlorine dioxide. This disinfection agent kills all bacteria, germs, viruses and fungi within shortest time – and it works with very low concentration.

The generator is working with the hydrochloric acid – chlorite process and uses diluted chemicals like hydrochloric acid (HCl 9%) and sodium chlorite (NaClO₂ 7.5%) in accordance to the following chemical equation:

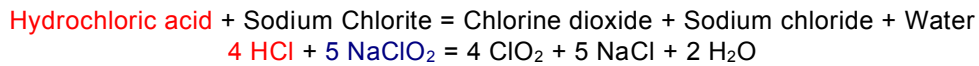

In the process each chemical is pumped with a specific proportion into a reactor vessel [5] by two dosing pumps [2 and 4]. Each stroke from each pump is triggered by the LOTUS-controller [1] and counter-controlled by a “SEFL” [6].

Inside the reactor vessel the chemicals are reacting to chlorine dioxide with a concentration of 2% (= 20 g/l).

In the next step a specific proportion of water is pumped into the reactor by a third dosing pump [3] to dilute the chlorine dioxide down to a concentration of approx. 2 g/l.

The finished chlorine dioxide leaves the reactor vessel through a back pressure valve [7] on the top of the reactor.

The advantages are:

- The chlorine dioxide can be pumped direct into pressurized systems with the pressure of the pumps and likewise into pressure-less storing tanks, to distribute the disinfection to different points of use.
- The System can work in proportional mode with contact water meter, current signal or chlorine dioxide measurement.



3. Construction

3.1 Construction overview

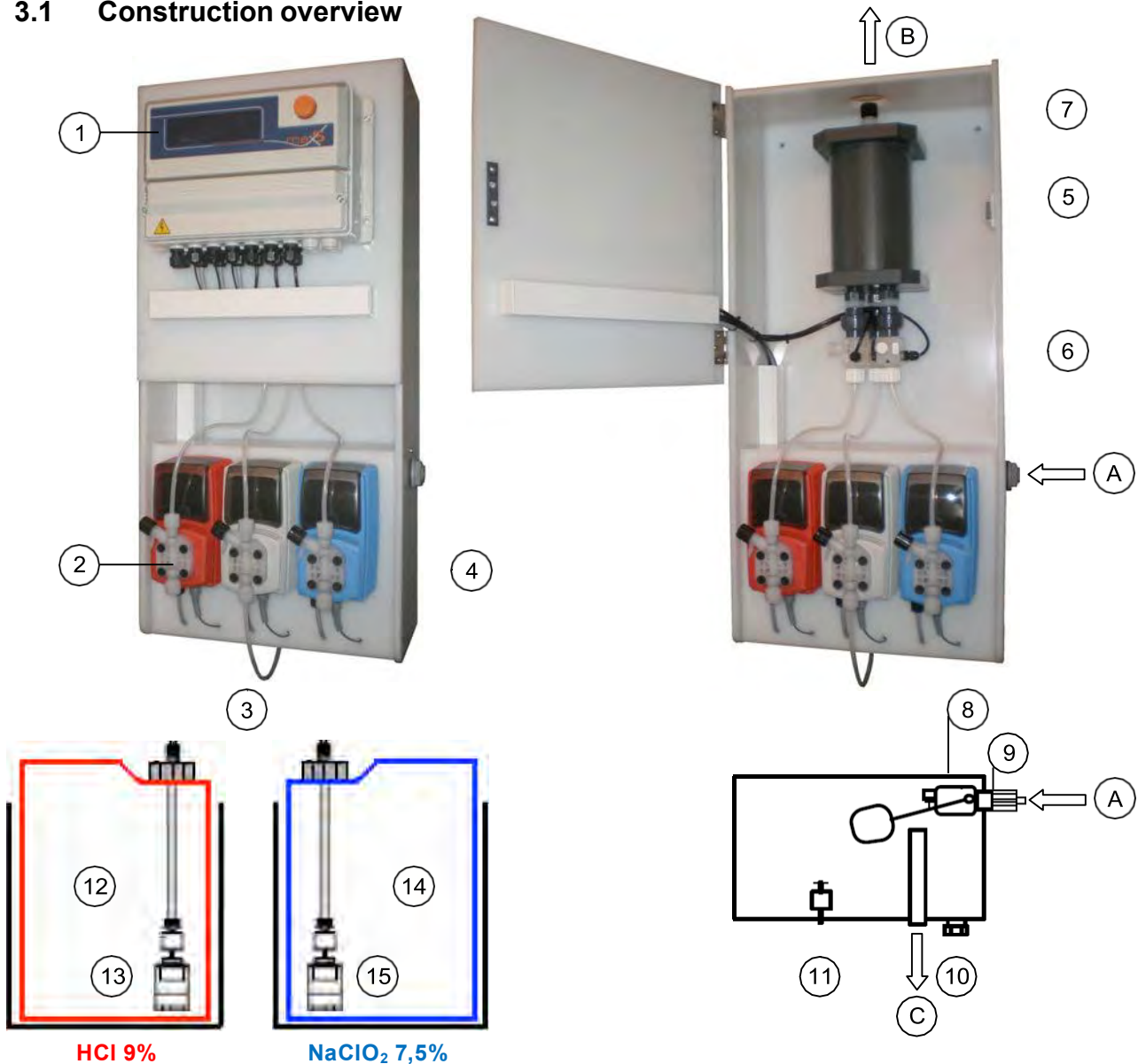

3.2 Description and details

- | | |
|--|---|
| <ul style="list-style-type: none"> 1 LOTUS-controller 2 Dosing pump for hydrochloric acid (HCl 9%) 3 Dosing pump for dilution water 4 Dosing pump for sodium chlorite (NaClO₂ 7,5%) 5 Reactor 6 Dosing control "SEFL"
each for hydrochloric acid, sodium chlorite
and dilution water 7 PVDF check-valve with hose-connection 4x6 mm 8 Storage tank for dilution water
(located behind the dosing pumps) 9 Floating valve | <ul style="list-style-type: none"> 10 Drain nozzle ½" 11 Level switch „Dilution water tank empty“ 12 Can with hydrochloric acid 9 % (ca. 95 g/l) 13 Suction lance with level-switch „Hydrochloric acid“ 14 Can with sodium chlorite 7,5 % (ca. 80 g/l) 15 Suction lance with level-switch „Sodium chlorite“ |
|--|---|
- A Hose-connection 4x6 mm for dilution water
 B Hose-connection 4x6 mm for chlorine dioxide (for PVDF hose)
 C Dilution water storage tank overflow

4. Installation



Warning:

- For the operation of the LOTUS generator the absolute observance of the national and local regulations is required. The operator is liable for the observance of the local safety instructions.
- The generator must be installed and started up in accordance to the regulations in this manual.
- The usage of installation parts not approved by the manufacturer or supplier is prohibited.
- The operation of the generator is allowed only with suitable safety-valves approved by the manufacturer. The contempt of this regulation results the ultimate loss of any warranty claims!
- Before starting works at the plant decompress all parts of the system.
- The plant never has to work against closed valves because of the risk of bursting hoses or pipes.
- Disconnect the power supply before opening the controller housing.
- Take care of all national regulations during installation!

4.1 General requirements to the installation location



Notice

- The plant must not be placed outdoors.
- The plant must be protected against unauthorized access.
- The installation location must be protected against sunlight and frost and well ventilated.
- For temperatures less than 10° C suitable tempering systems are required.
- It must be possible to carry the chemical cans to the plant without any restrictions.
- An escape route is stringent required!
- The plant must be mounted onto a vertical solid wall without tensions.
- The plant must be mounted in a way that no vibrations can be produced.
- Take care of free entrance from all sides for the operation and maintenance!
- A tap-valve and a lockable floor gully should be present for the risk-free removal of spilled chemicals.
- A fuse-protected power-supply (230 V CE-connector, 16 A) is required.

4.2 Requirements for the water



Warning:

Serious malfunctions at the plant or corrosion damages in the pipe-work of the treated water should be possible in case the following requirements to the water the chlorine dioxide is produced for as well as for the dilution water are not fulfilled:

Dilution water:

Temperature: 10 – 30° C

Pressure: 0.3 - 1 bar

Quality: Free of iron, manganese and particles, non-corrosive.

Treated water:

Temperature: > 5°C

Pressure: 6 bar max.

The following directions are based on a concentration for chlorine dioxide of 0.4 mg/l to prevent pipe-corrosion:

- The pH-level should be always higher than pH 6.5.
It should be controlled during operation.
- In case the carbonate hardness is lower 1.1° dH (German hardness) or the alkalinity is lower 0.4 mMol/l the dosing of suitable chemicals for the increase of the pH-level is required.
- In case the carbonate hardness is lower 19° dH (German hardness) the installation place of the injection valve for the chlorine dioxide (already made of PVDF) should be made of corrosion resistance materials (like PVC).

4.3 Assembly

- The plant must be mounted onto a vertical solid wall without tensions.
- The plant must be mounted in a way that no vibrations can be produced.
- The location should be nearby the chlorine dioxide injection point.
- Take care of free entrance from all sides for the operation and maintenance!
- The plant-bottom should be minimum 1 m over the floor-level.
- The level of the complete filled chemical cans must always be under the level of the dosing pumps.
- The maximum suction-height for the dosing pumps should be not more than 2 meters.
- Fix the plant with the two mounting-holes [P] on the backside to the wall.
Open the front door to reach the mounting-holes.



Notice

For a safety fastening hanger bolts M8 x 60 mm are suggested.



4.4 Hydraulic Installation

4.4.1 Installation to a pressure system

Systems with more than 0.5 bar operation pressure like drinking water treatment for hospitals, municipal buildings, retirement homes as well as cooling water treatment etc.

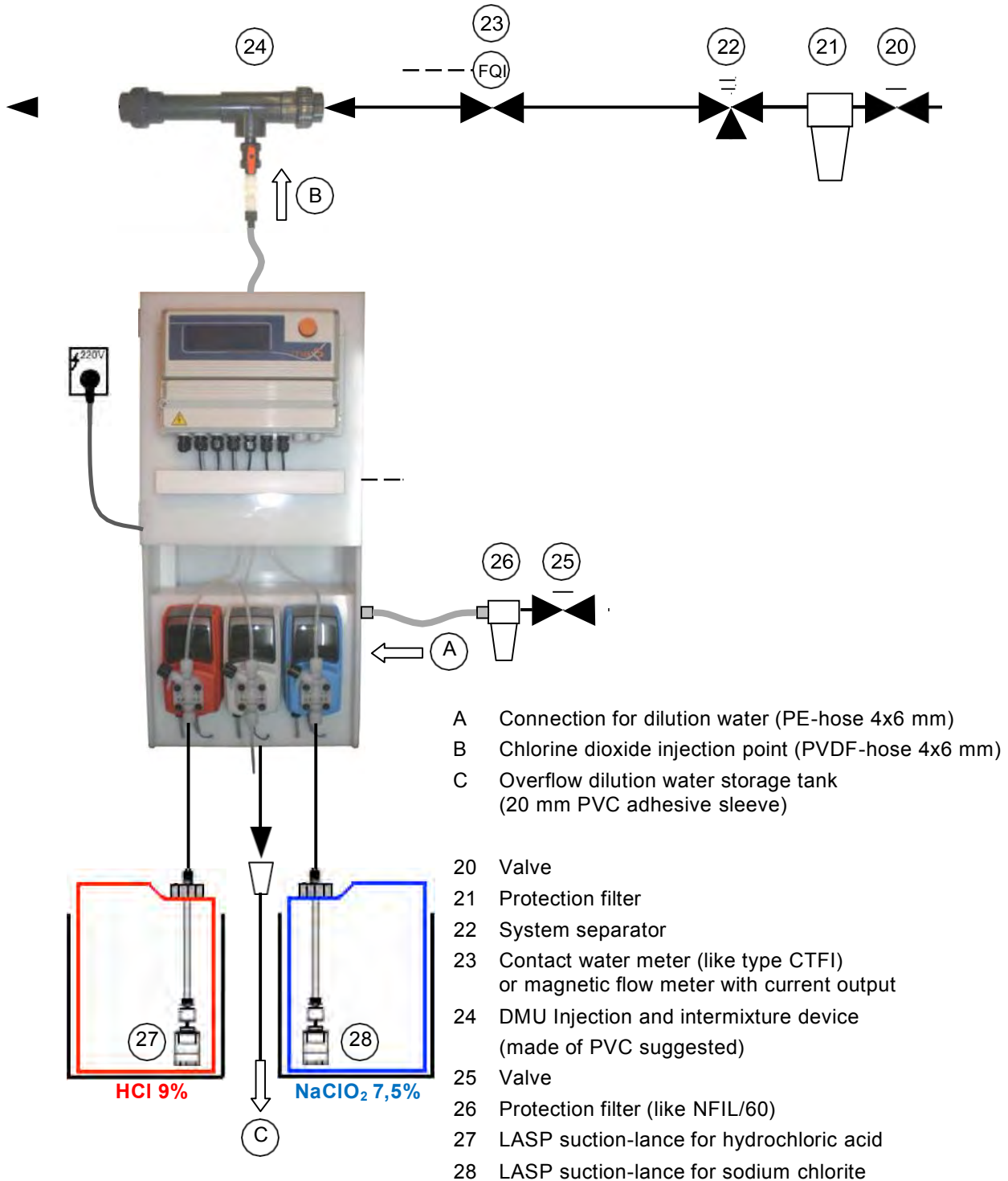

General information:



Warning:

In accordance to DIN 1988 a system separator is required in the main building feed line.



Notice:

- Take equal pipe dimensions and connections for the contact water meter and the intermixture device to ensure optimal hydraulic conditions.
- Take absolute care for the maximum permitted operation pressure (see label on the LOTUS)!

Contact water meter [23]



Warning:

Between the contact water meter and the point of injection no possibility for tapping water is allowed. Otherwise it can happen that the chlorine dioxide concentration can rise undue.

The LOTUS – controller is able to work with the following signals:

- Contact water meter with Reed-contact (like type CTFI)
- Contact water meter with open collector
- Water meter with analog output 4...20 mA

The water meter has to be placed after the system separator [22] and before the point of injection [24]. He must gather the complete amount of water which has to be injected with chlorine dioxide.

Use the following formula for the calculation of the optimal contact water meter to achieve a continuous dosing of chlorine dioxide without producing „clouds“:

$$\text{Pulse spacing} \leq \frac{1}{F \times \text{ClO}_2 - \text{desired concentration}} \quad [\text{Pulse/Liter}] \leq \frac{1}{F \times [\text{mg/l}]}$$

F = Factor based on the nominal size of the contact water meter:

- DN 15 = 2
- DN 20 = 2
- DN 25 = 4
- DN 32 = 7
- DN 40 = 15
- DN 50 = 20

Example 1:

In a well water supply with a nominal size of DN 20 a chlorine dioxide concentration of 0.1 mg/l is required:

$$\text{Pulse spacing} = \frac{1}{2 \times 0.1 \text{ mg/l}} = 5 \quad \text{Selection: Contact water meter type CTFI 20 – } \frac{3}{4} \text{“ with 4 pulse/liter}$$

Example 2:

In a well water supply with a nominal size of DN 50 a chlorine dioxide concentration of 0.1 mg/l is required:

$$\text{Pulse spacing} = \frac{1}{20 \times 0.1 \text{ mg/l}} = 0.5 \quad \text{Selection: Contact water meter type CTFI 50 – 2“ with 1 pulse/ 2 liter}$$



Notice:

Find more information in chapter “7.5.1 Proportional Mode”.

Injection and intermixture device [24]



Caution!

Don't install the injection valve direct into a metal tube. The chlorine dioxide will destroy the tube by corrosion in a short time. Select one of the following devices for the installation into metal pipe-works:

- Injection and intermixture device type „DMU“ [24]
- Injection lance made of PVDF like type „LINI-K“ (Option) as

Take care that the dosing hose [B] is protected against direct sunshine. The sun radiation degrades the chlorine dioxide back into its basic chemicals. Use a suitable protection hose (Option).

Multifunction valve



Warning:

- Don't remove the multifunction valve!
- The counter-pressure in the dosing line must be minimum 1 bar at any time!

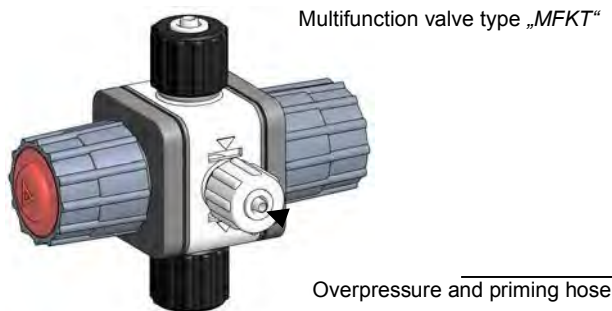

- With the yellow knob you can adjust the counter-pressure between 1 – 5 bar depending to the actual installation situation.
- The overpressure and priming hose is laid to the dilution water storage tank. In case of an overpressure the chlorine dioxide flows into the tank and will be diluted. From there it overflows into the drain.

Dilution water connection [A]

Inside LOTUS is a storage tank [8] for the dilution water. The automatic refill is controlled by a float valve [9]. The float valve has to be connected to the water line with a 4x6 mm PE-hose (2 m included in the delivery scope).



Notice:

- In case the pressure in the water line is more than 5 bar a pressure regulator valve in the re-filling line is required. The adjusting range should be 0.3 – 4 bar.
- For a proper function of the pressure regulator valve and the float valve inside the tank a protection filter like a "NFIL/60" is recommended.

Overflow connection [C] for the dilution water storage tank

The dilution water storage tank [8] has a overflow connection with a 20 mm PVC adhesive connection. The overflow should be connected to a floor drain.

4.4.2 Installation to a batch tank

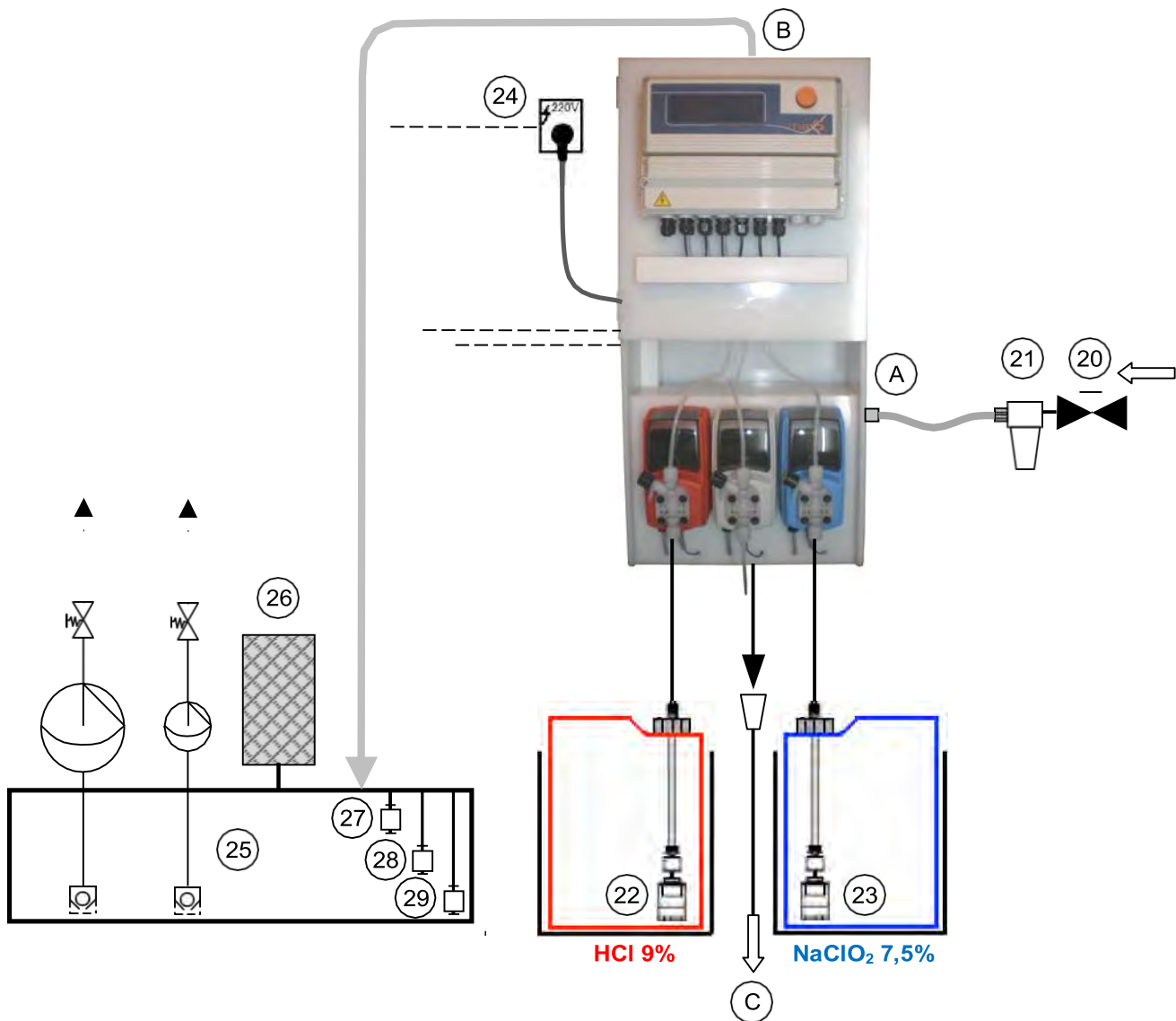

- A Connection for dilution water (PE-hose 4x6 mm)
- B Connection for chlorine dioxide outlet (PVDF-hose 4x6 mm)
- C Overflow of dilution water storage tank (PVC 20 mm adhesive muffle) to drain

- 20 Shut-off valve
- 21 Protection filter (like NFIL/60)
- 22 LASP suction-lance for hydrochloric acid
- 23 LASP suction-lance for sodium chlorite
- 24 Power supply controlled by a level-control in the batch tank [27] for „overflow emergency“
- 25 Batch tank
- 26 Active carbon filter for tank venting
- 27 Level-switch „Batch tank overflow“
- 28 Level-switch „Batch-Tank empty/start refill“
- 29 Level-switch „Batch-Tank full/stop refill“
- 30 Multifunction valve „MFKTS“

**Caution!**

Take care that the “MFKTS” – multifunction valve on the top of the reactor (inside LOTUS) is adjusted with a counter-pressure of minimum 1 bar!

Dilution water connection [A]

Inside LOTUS is a storage tank [8] for the dilution water. The automatic refill is controlled by a float valve [9]. The float valve has to be connected to the water line with a 4x6 mm PE-hose (2 m included in the delivery scope).

**Notice:**

- In case the pressure in the water line is more than 5 bar a pressure regulator valve in the re-filling line is required. The adjusting range should be 0.3 – 4 bar.
- For a proper function of the pressure regulator valve and the float valve inside the tank a protection filter like a “NFIL/60” is recommended.

Overflow connection [C] for the dilution water storage tank

The dilution water storage tank [8] has a overflow connection with a 20 mm PVC adhesive connection. The overflow should be connected to a floor drain.

4.5 Electrical Installation



Caution!

- Installation only made from an authorized expert!
- In Germany: Take the instructions of VDE 0165 into consideration.
In foreign countries: Consider the current national regulations!
- Risk of electric shock!
- Take care that the power supply meets the power requirements of LOTUS (see plant-label).
- Disconnect power supply before opening the controller housing!

4.5.1 Power supply

LOTUS has a standard cable with CE-connector. For the power supply a fail-saved humid room damp proved electric socket is required.



Notice:

- The electric socket has to be placed nearby LOTUS for easy disconnection in case of emergency stop or maintenance.
- The electric socket must be placed free for easy access from all sides.
- An overload protection for the power supply is stringent required!

4.5.2 Types of Control

Three different types of control are selectable:

- Proportional to the flow, controlled by a pulse frequency input:
 - e.g. by a contact water meter with Reed-contact (type „CTFI“),
 - a contact water meter with open collector or Hall-sensor,
 - or a magnetic flow meter (IDM).
- Analog with a current signal (4 ... 20 mA),
 - from a magnetic flow meter (IDM),
 - or a external chlorine dioxide measuring system (in Germany prohibited)
- Level-controlled filling of a batch tank

Depending to the required control the LOTUS-controller has to be configured and an option has to be ordered. Contact your dealer for more information.

5. Startup

5.1 Preparations

- Open the valve [25] for the dilution water storage tank. The tank starts filling until the float valve [9] shuts the line.
- Put the suction lances for hydrochloric acid (HCl 9%) and sodium chlorite (NaClO₂ 7.5%) into the cans.



Warning:

Wear protective clothes for the handling with hazardous chemicals!

5.2 Hydraulic startup

- Plug the power supply into the socket.
The LOTUS-controller starts with the start-display and shifts to the main-display after some seconds.

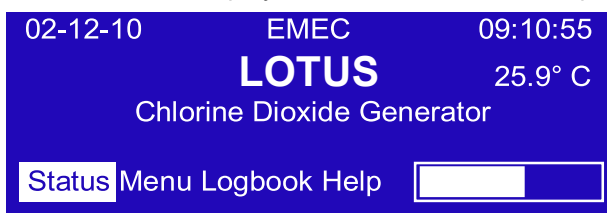

- Use the click-wheel, go to „Status“ and then to „Priming“. Push the click-wheel and open the sub-display for the manual mode.

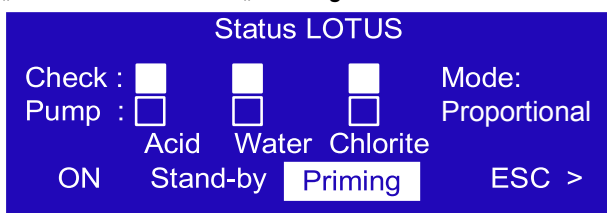

- Insert a time in field „Input“ and start the count-down with “Start”. All three pumps start running with max. pulse frequency.

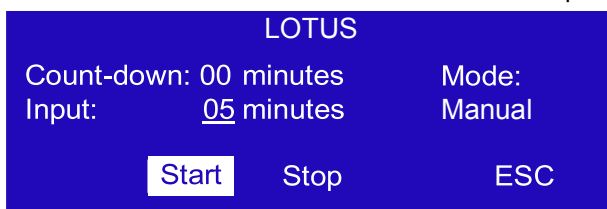

- Open the priming valves at the dosing pumps. The pumps keep on running until the count-down stops or the process is interrupted with the “Stop” button.
- Shut the priming valves as soon as the chemicals flow out without gas-bubbles back into the cans.
- Let the pumps keep on running to fill-up the reactor with chemicals and dilution water until the count-down stops.
- Push the click-wheel on “ESC” and leave the manual mode.
When the pumps are still running because the count-down is still activated you can verify with the blinking signals “Check” for the dosing control and “Pumps” for the dosing pumps if the pumps and suction- and delivery-hoses are proper vented.

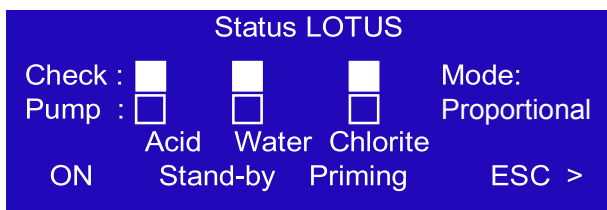

In case it is not, go back again into the “Priming” display and repeat the process.

- After successful priming start the configuration of LOTUS for the adaption to the local requirements.

6. „LOTUS“ Controller

6.1 Start display

When the power supply is switched on the start display appears and shows the actual software release for some seconds.



After approx. 3 seconds the program goes onto the main display.

6.2 Main display



The main display is separated into 5 lines::

- 1: Date and time
- 2: Measuring value for temperature (in case this option is implemented)
- 3: Type of plant
- 4: Information line for operation, status or failure messages (blinking)
- 5: "Click-Wheel" operation and duty line.
A constant running bar shows that the LOTUS is active.

6.3 Control element „Click-Wheel“

On the right side of the display a turning- and push-button is located. It is called „Click-Wheel“.

You can turn the click-wheel into both directions to scroll through the menus or select a function. The selected function is shown in an inverse color.



Turn for scroll

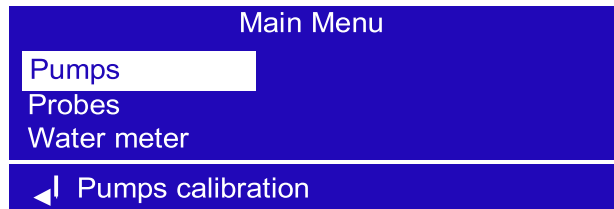

The actual position is shown **Inverse**.



Push for selection



Push the click-wheel for selection.

When you leave a sub-menu with **OK** or **Ex** you will be asked if you want to save the inputs or changes:



- Select „Yes“ to accept the inputs and changes.
- Select „No“ in case the previous settings should be preserved.

In case you leave a sub-menu with **ESC** and without any changes the previous settings are preserved.

6.4 Status Displays

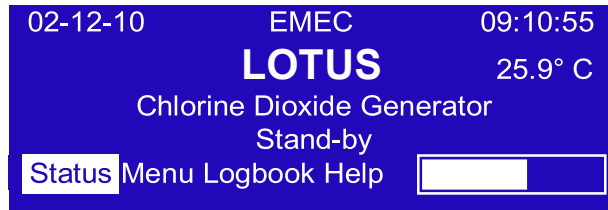

Push the click-wheel on “Status” to open 4 different operation displays:

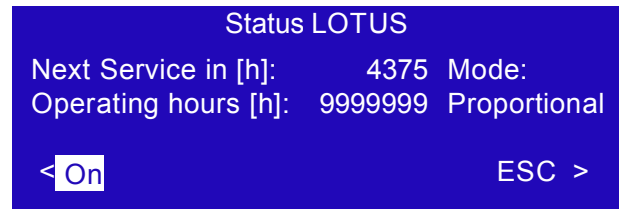
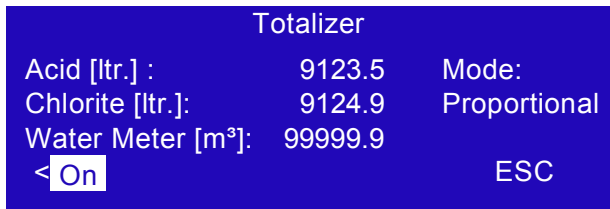
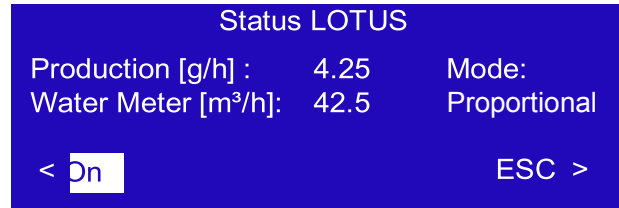
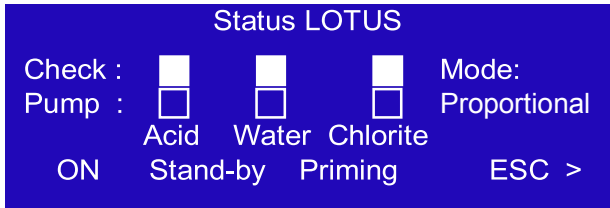

- Check: The signal lights are showing the function of the dosing controls.
At stagnant production the signal light shows .
During production the signal lights from the dosing controls “Check” are blinking inverse corresponding to the signals from the „Pump“.
That means: in the moment when a pump is doing a stroke (light =), the light of the dosing control has to show .
- Pump: See also „Check“.
- Mode: Shows the activated operation mode.
- Production: Shows the actual chlorine dioxide production capacity.
- Water Meter: Shows the actual flow capacity of the contact water meter.
- Next Service: Shows the remaining time until the next service is required.
- Operating hours: Shows the operating hours counter.

In the operation displays you have different options:

- ON/OFF** Start/Stop LOTUS
- STAND-BY** Switches LOTUS into the “Stand-by” mode, independent to the function of the “Stand-by” – Input
- PRIMING** Opens the display for dosing pumps priming resp. for manual mode
- ESC** Go back to the main display
- < or >** Scroll in the operation displays

6.5 Logbook

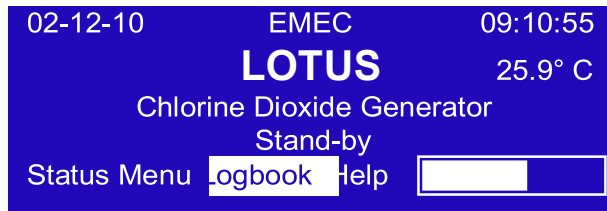

Turn the click-wheel onto the field “Logbook” and push it to open the sub-menu.

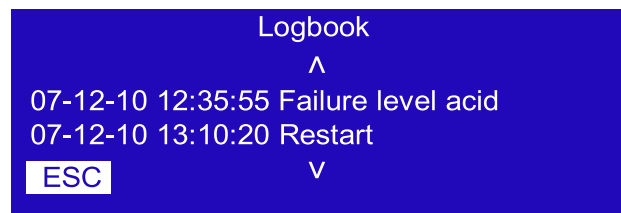
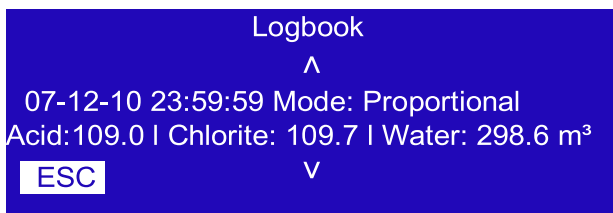

The LOTUS-controller has an internal logbook-memory. Two different types of data are stored together with a time-stamp: Operation data in periodic intervals and failure messages as soon as they appear.

Turn the click-wheel to scroll forward and backwards through the logbook.
Push the click-wheel on “ESC” for return to the main display.

6.6 Help

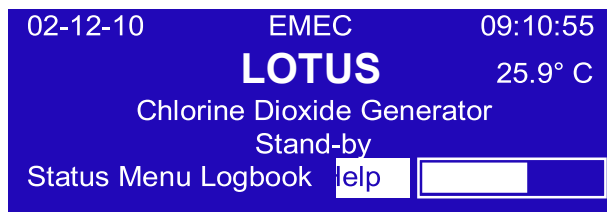

Turn the click-wheel onto the field “Help” and push it to open the “Help” display.



The “Help” display shows the contact data of your dealer.
Push the click-wheel on “ESC” for the return to the main display.

7. Main Menu



Push the click-wheel to open the main menu.

The access to the main menu is protected by a passcode:

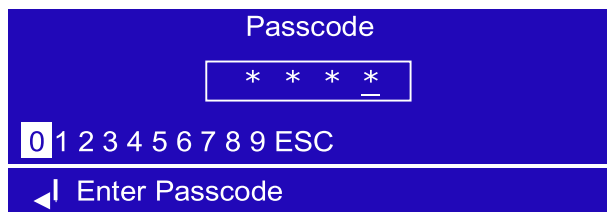

Select a four-digit number-code. As soon as the fourth correct digit is selected the main menu opens automatically.



Caution!

- Access to the main menu for authorized service technicians only!
- The passcode is stored in appendix A: "Test Certificate" or you find it in chapter „7.7 System Settings“ (factory defaults).

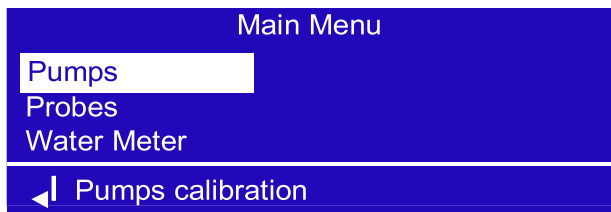

Sub-menus:

- Calibration of the dosing pumps
- Calibration of the chlorine dioxide and temperature probe
- Configuration of the input for a water meter

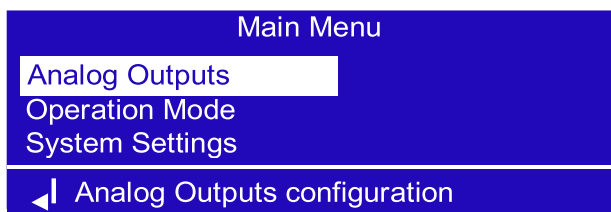

- Configuration of the analog outputs
- Selection of operation mode
- System settings

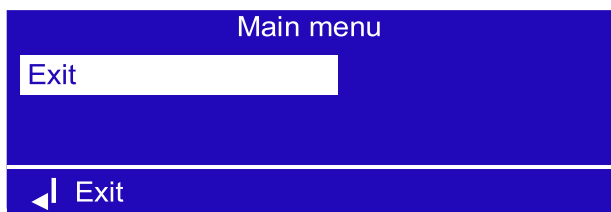

- Back to main display

7.1 Pumps – Calibration of dosing pumps

For an accurate production of chlorine dioxide a proper calibration of the dosing pumps is essential. The exact calibration ensures the maximum yield of the chemicals and the minimization of the chemical consumption. For this a periodic maintenance with a pumps calibration is required.

A calibration has to be executed:

- At the first startup or restart after a shut-down period.
- At every periodic maintenance.

Calibration:

1. Attach the calibration cylinder sidewise to the LOTUS housing.
2. Disconnect the suction hose from one pump and connect the PVC-hose from the calibration cylinder to the pump.
3. Fill the calibration cylinder with water.
4. Go into the “*Priming*” mode and vent the suction hose of the calibration cylinder.
5. Refill the calibration cylinder until the “0” ml tag.



5. Enter the Main menu and open the sub-menu “*Pumps*”.

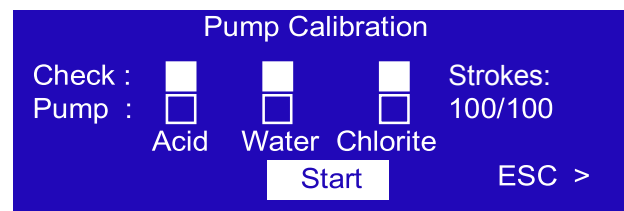
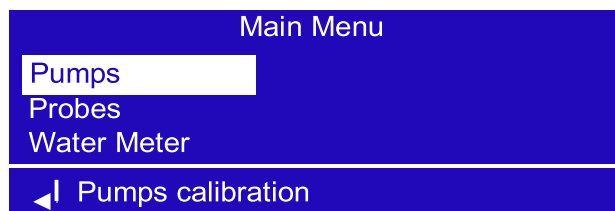

5. Push the click-wheel on “*Start*”.

All three dosing pumps are executing 100 strokes (see the count-down in field “*Strokes*”). An additional display opens when they finished.

6. Read the “*ml*”-level from the calibration cylinder and insert the value into the input-field depending to the corresponding pump.

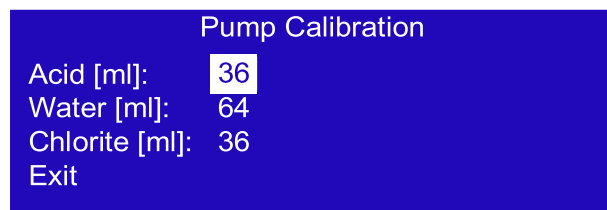

7. Leave the display with “*Exit*” and save the changes with „*Save*“. Repeat the procedure with the two other pumps as shown above.

7.3 Contact water meter

For the proportional production of the chlorine dioxide the connection of a contact water meter is required.

The LOTUS-controller can work with the following types of water meters:

- Contact water meter with Reed-contact (like type CTFI)
- Contact water meter with open collector
- Water meter with analog output 4...20 mA (like a magnetic flow meter)

In the sub-menu „Water Meter“ LOTUS can be optimal adapted to the connected water meter.

Enter the main menu and open the sub-menu “Water Meter”.

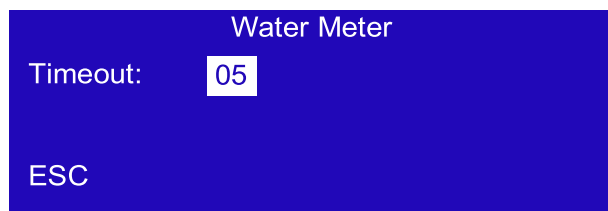
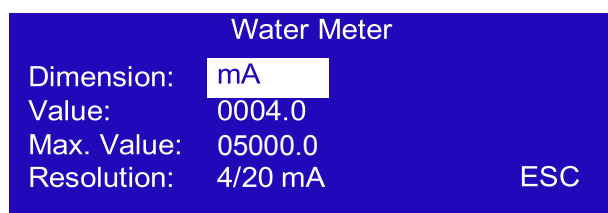
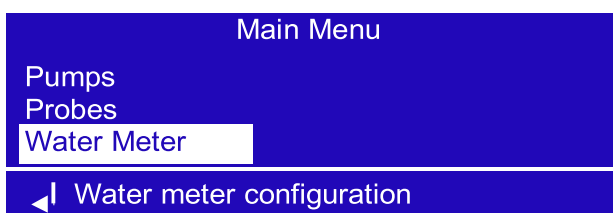

Dimension: Select the dimension you want to insert in field “Value”. Chose between pulse per liter „Imp./Ltr.“, or liter per pulse „Ltr./Imp.“ or “mA” using a mA pulse sender Water Meter.

Value: Insert the pulse spacing (see also chapter 4.4.1).

Max. Value: This input is only for water meters with analog output (0/4...20 mA). You have to insert the maximum flow of the water meter in m³/h corresponding to 20 mA.

Resolution: Here you have to select the type of analog output of the water meter. You can chose „0/20 mA“ or „4/20 mA“.



Notice:

This function is activated only in case the option “Analog” was ordered.

Timeout: The “Timeout” function acts as an optimizer for the proportional mode in case a contact water meter is connected to LOTUS and

- a) The flow is fluctuating very strong in short periods
- b) The pulse spacing of the water meter is extreme inconvenient.

The range is between 0 – 20 seconds. “0” deactivates the function.

What is the principle?

As soon as the first pulse from the water meter is noticed, Lotus starts the production with 100% capacity (= maximum stroke frequency). Parallel the controller is counting the time until the next pulse appears. With this information LOTUS can calculate the flow and the required production capacity to readjust the stroke frequency for the pumps.

In case the water meter produces more pulses than LOTUS is able to produce chlorine dioxide proportional to the flow (failure message “OVERFLOW”), the controller buffers the pulses and execute them later. But only for the timeout span to avoid overdosing in case the water flow stops immediately during the timeout.

7.5 Analog outputs

Optional there are 2 analog outputs available for the chlorine dioxide and the temperature measuring values. In case LOTUS is equipped with the option you can select the output resolution in this sub-menu.

Enter the main menu and open the sub-menu "Analog Outputs".

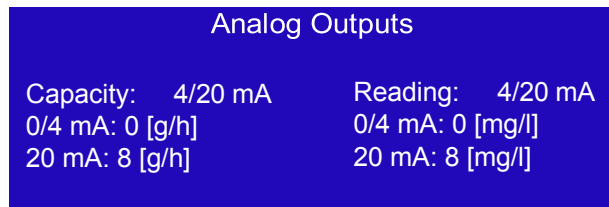
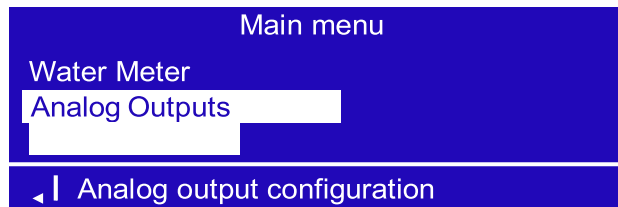

Capacity: Here you have to select the analog output value based on production gr/h.

Choose between 0/20 or 4/20 mA.

Reading: Here you have to select the analog output value based on ClO₂ probe reading.

Choose between 0/20 or 4/20 mA.

CURRENT OUTPUT VERSION (mA) main board blocks:

Capacity: 13 (-) ; 15 (+)

Reading: 13(-) ; 16(+)

7.5 Operation mode

LOTUS can work in different operation modes.

Enter the main menu and open the sub-menu "Operation Mode".

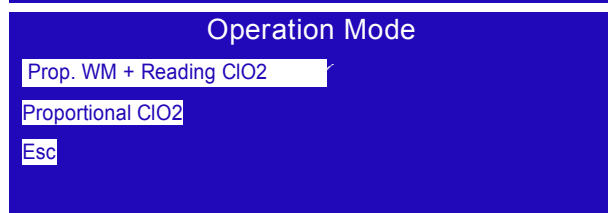
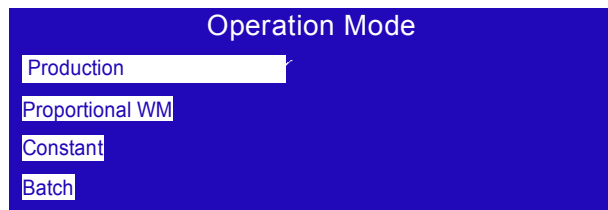
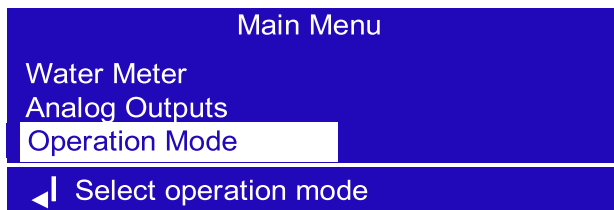

Production: In this mode user can choose dioxide production gr/h (grams per hour) based on maximum controller capacity

Proportional (WM): In this mode LOTUS produces an adjustable capacity of chlorine dioxide proportional to a water flow recorded by a water meter.

Constant: In this mode LOTUS is producing chlorine dioxide with a constant and adjustable capacity as long as input "Stand-by" is not activated.

Batch: In this mode LOTUS fills up a level-controlled batch tank with chlorine dioxide in an adjustable concentration.

Prop. WM + Reading ClO2: In this mode LOTUS produces an adjustable capacity of chlorine dioxide proportional to a water flow recorded by a water meter. In addition an internal chlorine dioxide measurement controls the concentration and downsizes the production capacity in case of a set-point overriding.

Proportional ClO2: Dosing activity based on ClO2 setpoint

7.5.1 Proportional (WM) mode

In the proportional mode LOTUS produces an adjustable capacity of chlorine dioxide proportional to a water flow recorded by a water meter.

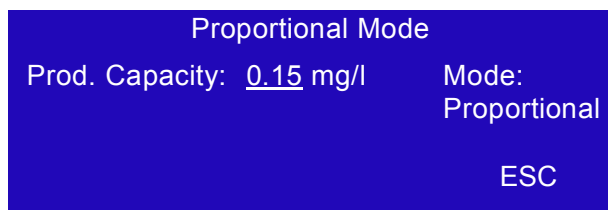

Prod. Capacity: Here you can adjust the requested chlorine dioxide concentration.



Warning:

- The controller takes the inserted value in “*Prod. Capacity*” for the calculation of the required stroke frequency of the dosing pumps for the production of chlorine dioxide proportional to the flow. This means that it is a theoretically value and not the real concentration in the water!
- The operator is responsible by its own for the proper adjustment of this control-value!
- The operator has to countercheck the chlorine dioxide concentration in the connected water system with a suitable photometer to verify the real concentration and to readjust the “*Prod. Capacity*” until the required concentration is stable achieved.



General Notices:

Theoretically it is possible to adjust the production capacity up to 9.99 mg/l.

But for very low water flows, resp. water consumption it can be dangerous to do this and should be absolutely avoided!

In case the water flow exceeds the maximum production capacity a proportional production is not longer possible. In the following table you can find the maximum water flow corresponding to the maximum production capacity:

LOTUS	8	20
Production capacity [mg/l]	Water flow [m³/h]	
0,10	80	200
0,20	40	100
0,30	26.6	66.6
0,40	20	50
0,50	16	40
0,60	13.3	33.3
0,70	11.4	28.5
0,80	10	25
0,90	8.8	22.2
1,00	8	20

The overriding of the maximum possible production capacity caused by the water flow is shown on the display with a special blinking message “*Overflow*”:

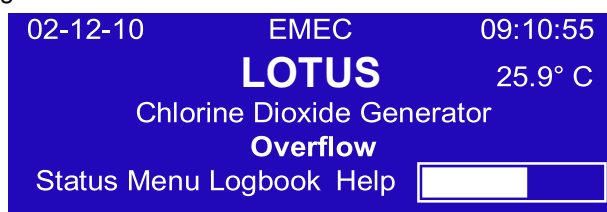

As soon as the water flow drops down under the maximum acceptable value, the message disappears.

7.52 Constant mode

In this mode LOTUS is producing chlorine dioxide with a constant and adjustable capacity as long as input “Stand-by” is not activated. Two different capacities can be adjusted depending to the digital inputs “Batch tank empty” [terminal 29 and 30] and “Stand-by” [terminal 54 and 55].

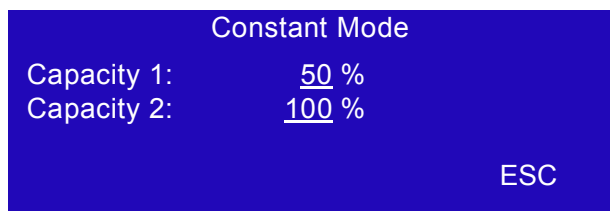

Capacity 1: In this field you can adjust the production capacity for the digital input “Batch tank empty”.

Capacity 2: In this field you can adjust the production capacity for the digital input “Stand-by”.

Situation	STAND-BY (54, 55)	BATCH TANK EMPTY (29, 30)
LOTUS “STAND-BY”		
Capacity 1		
Capacity 2		

7.53 Analog mode

In this mode the chlorine dioxide production capacity is controlled by an external analog signal (0/4 – 20 mA).

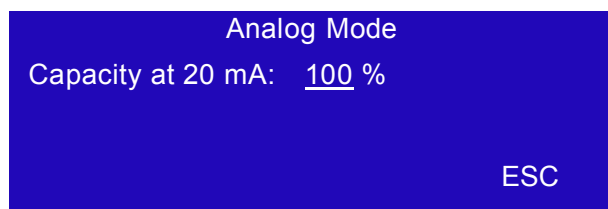
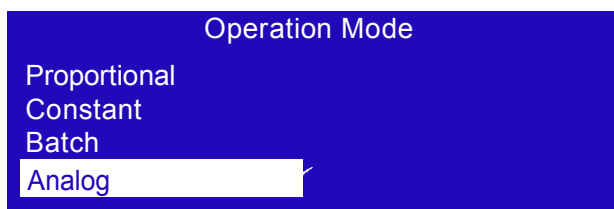

Capacity at 20 mA: Here you adjust the maximum production capacity for a 20 mA input signal.



Notice:

Independent to the selected operation mode LOTUS stops as soon as the digital input “Stand-by” appears!



Notice:

The “Analog” mode is available only in case the option is ordered.

7.54 Batch mode

In this mode LOTUS fills up a level-controlled batch tank with chlorine dioxide in an adjustable concentration. The two digital inputs “*Batch tank empty*” [terminal 29 and 30] and “*Stand-by*” [terminal 54 and 55] are used for the level-control.

Situation	Step	Terminal 29, 30	Level tank empty	Terminal 54, 55	Level tank full
Tank empty	1		<input type="checkbox"/>		<input type="checkbox"/>
Level is rising	2		<input checked="" type="checkbox"/>		<input type="checkbox"/>
Tank full	3		<input checked="" type="checkbox"/>		<input checked="" type="checkbox"/>
Level falls down	4		<input checked="" type="checkbox"/>		<input type="checkbox"/>
Tank empty	1		<input type="checkbox"/>		<input type="checkbox"/>

Step 1:

```

Status
Level Tank full :       Mode:
Level Tank empty:     Batch
Start Filling Batch Tank
< ESC >
  
```

Step 2:

```

Status
Level Tank full :       Mode:
Level Tank empty:   Batch
Filling Batch Tank
< ESC >
  
```

Step 3:

```

Status
Level Tank full :     Mode:
Level Tank empty:     Batch
Batch Tank full
< ESC >
  
```

Step 4:

```

Status
Level Tank full :       Mode:
Level Tank empty:   Batch
Draining Batch Tank
< ESC >
  
```

In case one of the level-switch failed or the cable is damaged a failure message appears:

Failure Level-switch:

```

Status
Level Tank full :     Mode:
Level Tank empty:       Batch
Failure Level-Switch
< ESC >
  
```

```

02-12-10      EMEC      09:10:55
                LOTUS      25.9° C
Chlorine Dioxide Generator
Failure Level-Switch
[Status] Menu Logbook Help [ ]
  
```

7.5.5 Prop. & Reading mode

In this mode LOTUS produces an adjustable capacity of chlorine dioxide proportional to a water flow recorded by a water meter. In addition an internal chlorine dioxide measurement controls the concentration and downsizes the production capacity in case of a set-point overriding.

Operation Mode	Prop. & Reading Mode
Constant	Set-Point: <u>0.10</u> mg/l
Batch	Limit value: <u>0.15</u> mg/l
Analog	
Prop. & Reading	ESC

Set-Point: Here you can adjust the requested chlorine dioxide concentration before LOTUS is readjusting the production capacity.

Limit value: Here you can adjust the maximum acceptable concentration before LOTUS downsizes the production capacity.



Notice:

The “*Prop. & Reading*” mode is available only in case the option is ordered.

7.6 System settings

This menu is for basic settings.

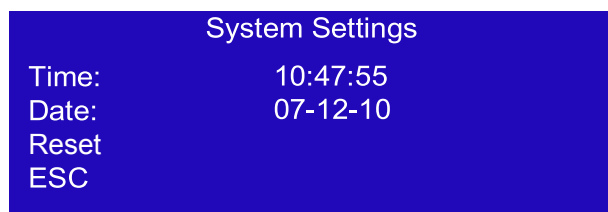
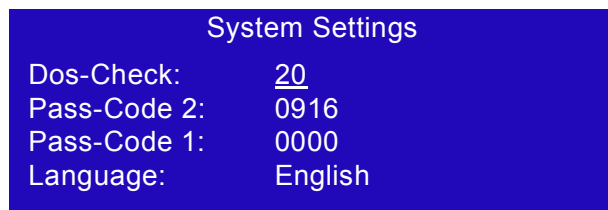
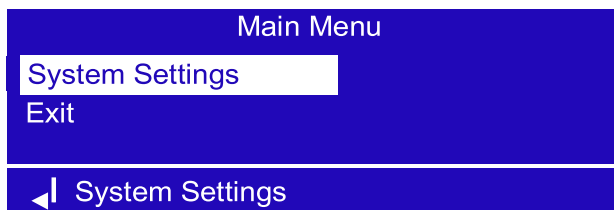

Dos-Check: Here you can preset the number of failed strokes from the dosing pumps without response from the dosing controls. When the controller counts this number LOTUS stops and a failure message appears.

Setting range: 0 – 50. With “0” the function is deactivated.

Pass-Code 2: This passcode activates **the main menu** and is dedicated for the authorized service technician only!

Here you can change the passcode. It is active as soon as you exit to the main display.

Setting range: 0000 – 9999. **Default value: “0 9 1 6”.**



Caution!

Write the new passcode down in your documents or into the „Test Certificate” (appendix A) for later using!

Without the passcode you cannot open the main menu again!



Notice:

Executing a “Reset” (see below) sets the passcode back to the default value “0 9 1 6”.

Pass-Code 1: This passcode is for the operator. It activates an additional display where he can readjust the production capacity depending to the activated operation mode.

Here you can change the passcode during startup by the demand of the operator. It is active as soon as you exit to the main display.

Setting range: 0000 – 9999. **Default value: “0 0 0 0”.**

Language: Here you can select the language for the displays.
You can chose English or German.

Reset: In this display you can execute a reset to the factory default values.

Time: Here you can adjust the internal clock for the time stamps in the logbook.
Date:

Connections to the mainboard

Before performing any operation on the Block board of the instrument, it is mandatory to disconnect it from the mains. To facilitate the connections to the mainboard, it has been divided into two blocks: electrical connections and I/O connections.



Unplug power cable from main power supply before operate

Danger

Blocks numbering is relative to the area on which you are working!

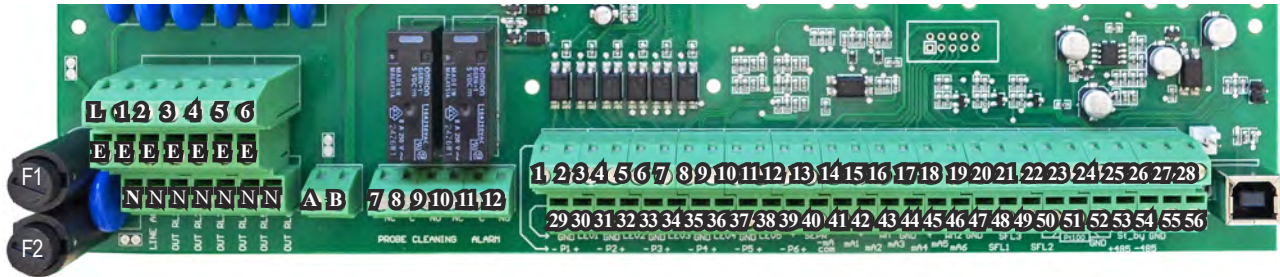

Electrical Connections



I/O Connections

Electrical connections:

F1: Main fuse (6.3AT)

F2: Instrument fuse (3.15AT)

MAIN POWER SUPPLY (115VAC / 240VAC): L(Phase), E(Earth), N(Neutral)

SET-POINT OUTPUTS (115VAC TO 240VAC):

(free contact outputs are not protected with a fuse and isolation between the outputs and the power supply is 250V MAX):

GENERAL ALARM OUTPUT:

5 - E - N (F2 Fuse-protected) Alarm Out

10(N.C.), 11(C), 12(N.O.)

I/O Connections:

OUTPUTS FOR DIGITAL SIGNAL PROPORT. PUMP:

1(-) ; 2(+): Acid pump signal
output 3(-) ; 4(+): Chlorine pump
signal out 5(-) ; 6(+): Water
signal out

INPUTS:

21(-) ; 20(+): SEFL IN 1
23(-) ; 22(+): SEFL IN 2
49(-) ; 48(+): SEFL IN 3

MA OUTPUTS (MAX LOAD 500 OHM):

13: Common
15: Production
16: Reading

RS485:

26: + Signal 485 (A)
27: - Signal 485 (B)

TANKS LEVEL INPUT:

29(-) ; 30(+): TANK EMPTY BATCH | CAP 2 (Constant Mode)
35(-) 36(+): ACID
;37(-) 38(+): CHLORINE

FLOW sensor (mod. "SEPR") input: 39(+ Brown) ; 40(Black) ; 41(- Blue)
41 shortcut with block n.37

CONTACT input: 39(White) ; 40(Black)
41 shortcut with block n.37

(Hall effect) pulse sender water meter (makeup water): 42(+12VDC) ; 43(INPUT) ; 44(GND)
(Contact) Pulse sender water meter (makeup water): 43(INPUT) ; 44(GND)

Temperature Probe input (mod. "ETEPT"): 50(green) ; 51(brown) ; 52(white) ; 53(yellow)
(remove resistance before to install probe)

Temperature Probe input (PT100) with ECDIND probe: 50(green) ; 51(orange or pink) ; 52(white) ;
53(yellow)

STANDBY input: 54(+) ; 55(GND)* *BATCH TANK FULL / CAP1 CONSTANT

OVERFLOW WATER TANK: 31(-); 32 (+) contact for maximum level into storage tank

LOTUS Terminal board

Attention: all connections must be executed by qualified personnel

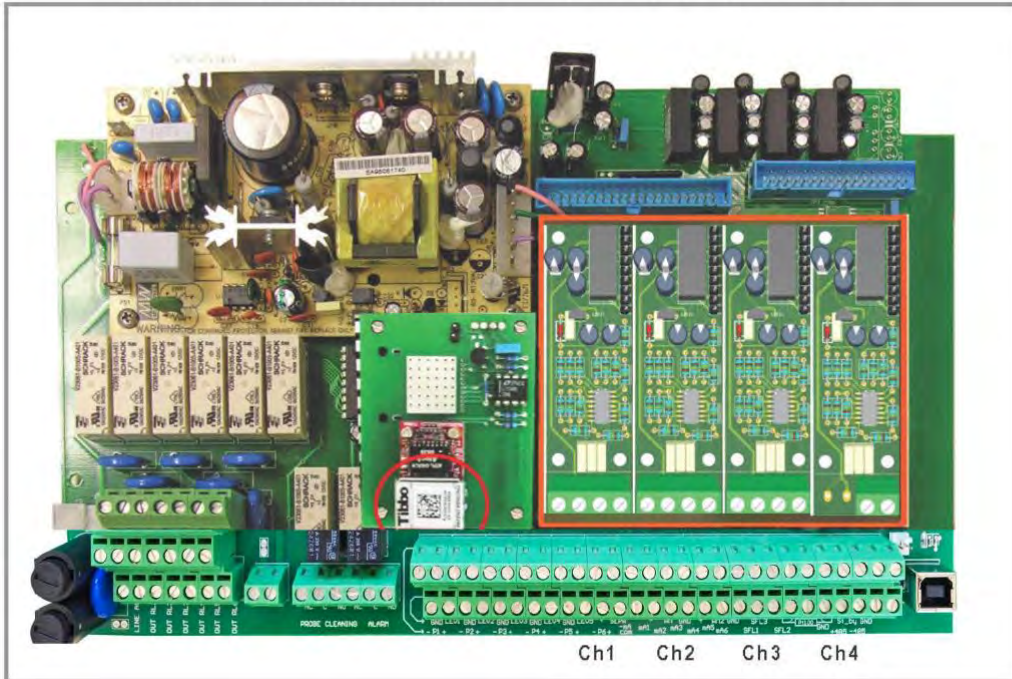

Danger

Unplug power cable from main power supply before operate

MDMA module
0/20 mA water meter
input Slot 4

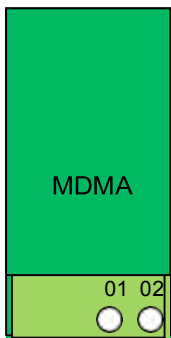

Chlorine dioxide
measuring module
(Option)



Brown (+)
White (-)
Green (Signal)
Yellow (GND)

Chlorine dioxide
measuring module
(Option)



N.C.
N.C.
- (Black)
+ (Red)

Slot
3

SLOT 3 (option)
mV module for
ORP probe

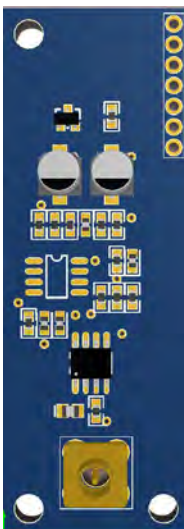

SLOT 3

Connect chlorine probe (mod. SCLxx) to this module as follows:

- 1 (-485) green wire
- 2 (+485) white wire
- 3 (GND) black wire
- 4 (+5VDC) red wire



ADDENDUM DIOXIDE PROBE SAFETY SYSTEM

Dioxide Probe

Use this function to setup sensor that detects dioxide into air. This option is useful during a plant's dioxide leakage to prevent dangerous high dioxide concentration. To set this value refer to the sensor sensitiveness as printed on head's label (see below picture). **Do not edit this function if not otherwise specified or if unsure of value to enter.**

Other options are:

MAIN MENU: HIDE to not show a warning message. Use exclusively if no sensor is connected.

MAIN MENU: SHOW to enable warning message and related alarm on main screen. Enabled by default.

Attention: this procedure assumes that the instrument is configured properly and connected to a working sensor, otherwise the results may not be reliable.



Dioxide into air main sensor head

Dioxide into air alarm

Use this menu to set a maximum dioxide into air concentration value into environment. Don't change this value if unsure of value to enter. **Do not edit this function if not otherwise specified.**

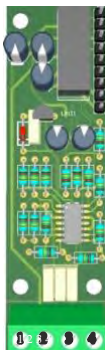

Connection:

Block 1 : (+12VDC) Brown

Block 2 : (-12VDC) White

Block 3 : (V-out) Green

Block 4 : (GND) Yellow

DIOXIDE SENSOR MODULE

Slot 2

10. Technical Data

		LOTUS MNI 8	LOTUS MINI 20
ClO ₂ production capacity	g/h	8	20
Maximum operation pressure	bar	10	10
Chemical consumption at max. production	l/h	each 0.2	each 0.5
Concentration of ClO ₂ stock solution	g/l	approx. 2 - 20	
Power supply		90 – 265 V, 50/60 Hz	
Energy consumption	w/h	50	
Protection class		IP 65	
Dimension:			
Width	mm	450	
Height	mm	1080	
Depth	mm	360	
Transportation weight	kg	approx. 30	

11. Failure messages

In case of a malfunction a message appears on the display and LOTUS stops.

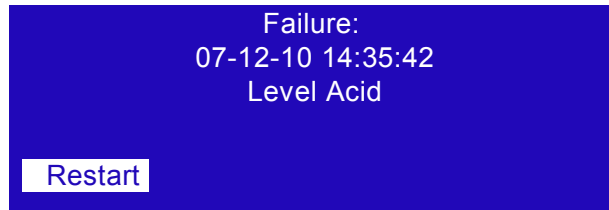

Remove the malfunction and restart LOTUS.

Message	Problem	Solution
Level Acid	One of the chemical cans or the dilution water storage tank is empty.	Change the chemical can and prime the pump.
Level Water		Check the supply line for the dilution water storage tank. Prime the pump.
Level Chlorite		Change the chemical can and prime the pump.
Contact Batch Tank Empty Level	The cable of the level-switch is disconnected or has a damage	Check the proper function of the level-switch.
Flow control Acid	A dosing control is recognizing lack of or no dosing.	Prime the corresponding pump. Readjust the flow-sensitivity at the dosing control.
Flow control Water		
Flow control Chlorite		
Contact SEFL Acid	A cable of the dosing control is damaged or disconnected.	
Contact SEFL Water		
Contact SEFL Chlorite		
Analog Input	The analog input signal is lower 3.5 mA.	Check the signal supply device. Check the signal cable for damages.
Service required		



Notice:

The two alarm output relays (terminal 5-E-N) and (terminal 10 (NC) – 11 (C) – 12 (NO)) are switching on in case of a malfunction. The relays are falling off as soon as the removal of the malfunction is confirmed with the "Restart" button.



Disposal of end-of-life equipment by users

This symbol warns you not to dispose of the product with normal waste. Respect human health and the environment by giving the discarded equipment to a designated collection center for the recycling of electronic and electrical equipment. For more information visit the online site.



When dismantling a pump please separate material types and send them according to local recycling disposal requirements. We appreciate your efforts in supporting your local Recycle Environmental Program. Working together we'll form an active union to assure the world's invaluable resources are conserved.